



XK

OWNER'S HANDBOOK

Publication Part No. **JJM 10 02 30 101**

This handbook forms part of the Owner literature supplied with your new vehicle. Left-hand drive and right-hand drive conditions may be shown in the graphics and where information is specific to a particular country, it is indicated as such.

Please take the time to study the operating instructions with your vehicle as soon as you can.

Important

The information contained in this handbook covers all vehicle derivatives and optional equipment. Some of the options may not be fitted to your vehicle, unless they formed part of the original vehicle specification. Therefore, some parts of this handbook may not apply to your vehicle. Furthermore, due to printing cycles, it may include descriptions of options before they become generally available.

The options, hardware and software in your vehicle are from the available specifications for the market in which the vehicle was intended for sale. If your vehicle is to be used in another geographical area, you may have to modify the vehicle specification to suit local conditions. Jaguar Cars Limited is not responsible for the cost of any modifications.

The information contained in this publication was correct when it went to print. Vehicle design changes may have been made after this handbook was printed. When this occurs a handbook supplement is added to the literature pack. Subsequent updates can be viewed on the Jaguar Internet site at: **www.ownerinfo.jaguar.com**.

In the interest of development, the right is reserved to change specifications, design or equipment at any time without notice and without incurring any obligations. This publication, or part thereof, may not be reproduced nor translated without our approval. Errors and omissions excepted.

© Jaguar 2008

All rights reserved.

Published by Jaguar Technical Communications.

Contents

Introduction

SYMBOLS GLOSSARY	9
LABEL LOCATIONS	9
FACIA AND CONTROLS.....	10
HEALTH AND SAFETY.....	12
DATA RECORDING.....	12
DISABILITY MODIFICATIONS	12
PARTS AND ACCESSORIES.....	13

Keys and remote controls

PRINCIPLE OF OPERATION	15
GENERAL INFORMATION ON RADIO FREQUENCIES	15
USING THE JAGUAR SMART KEY	16
UNLOCKING AND DISARMING THE VEHICLE	17
LOCKING AND ARMING THE VEHICLE	18
DOCKING/UNDOCKING THE JAGUAR SMART KEY	18
PROGRAMMING THE REMOTE CONTROL.....	20
CHANGING THE REMOTE CONTROL BATTERY	21
EMERGENCY KEY BLADE	22

Locks

LOCKING AND UNLOCKING FROM OUTSIDE THE VEHICLE	23
LOCKING AND UNLOCKING FROM INSIDE THE VEHICLE.....	23
USING THE EMERGENCY KEY BLADE	24
VALET MODE	26
JAGUAR SMART KEY SYSTEM TRANSMITTERS	27
KEYLESS ENTRY	28
GLOBAL OPENING AND CLOSING	29

Alarm

ARMING THE ALARM	30
DISARMING THE ALARM	31
TILT SENSOR.....	32
INTRUSION SENSOR	32
SENSOR FAULTS	32

Seats

SITTING IN THE CORRECT POSITION	33
ELECTRIC SEATS	34
HEAD RESTRAINTS.....	36
HEATED SEATS	37
CLIMATE SEATS.....	37

Seat belts

GENERAL INFORMATION	39
FASTENING THE SEAT BELTS	41
SEAT BELT REMINDER	41
INERTIA REEL MECHANISM TEST	41
AUTOMATIC LOCKING RETRACTORS.....	42
USING SEAT BELTS DURING PREGNANCY....	42

Supplementary restraints system

PRINCIPLE OF OPERATION.....	43
OCCUPANT SENSING	45
DRIVER AIRBAG.....	47
PASSENGER AIRBAG	48
SIDE AIRBAGS	49
AIRBAG WARNING LAMP	49
WHIPLASH PROTECTION.....	49
ROLLOVER BARS	50
AIRBAG LABELS.....	50
AIRBAG SERVICE INFORMATION.....	51

Child safety

CHILD SEATS	52
CHILD SEAT POSITIONING	54
CHILD RESTRAINT TOP TETHER ANCHORAGES	55
BOOSTER CUSHIONS.....	57
ISOFIX ANCHOR POINTS.....	57

Pedestrian protection

PRINCIPLE OF OPERATION.....	61
AFTER DEPLOYMENT OF THE PEDESTRIAN PROTECTION SYSTEM	61

Contents

Steering wheel

ADJUSTING THE STEERING WHEEL	62
STEERING COLUMN LOCK	63
HORN	63
HEATED STEERING WHEEL.....	63
AUDIO CONTROL	64
CRUISE CONTROL.....	64

Lighting

LIGHTING CONTROL	65
REAR FOG LAMPS.....	67
HEADLAMPS - DRIVING ABROAD	68
HEADLAMP LEVELLING	68
HAZARD WARNING FLASHERS.....	68
ADAPTIVE FRONT LIGHTING SYSTEM (AFS)	69
DIRECTION INDICATORS	71
INTERIOR LAMPS	71
CONVENIENCE HEADLAMPS.....	72
CHANGING A BULB	73
BULB SPECIFICATION CHART	78

Wipers and washers

WINDSCREEN WIPERS	79
RAIN SENSOR	80
WINDSCREEN WASHERS.....	80
HEADLAMP WASHERS.....	81
CHECKING THE WIPER BLADES	82
CHANGING THE WIPER BLADES.....	82

Windows and mirrors

ELECTRIC WINDOWS.....	83
EXTERIOR MIRRORS	86
INTERIOR MIRROR	88

Instruments

INSTRUMENT PANEL OVERVIEW	91
WARNING LAMPS AND INDICATORS	92
AUDIBLE WARNINGS AND INDICATORS	96

Information displays

GENERAL INFORMATION.....	97
WARNING AND INFORMATION MESSAGES... ..	98
TRIP COMPUTER	99
TOUCH-SCREEN.....	101
PERSONALISED SETTINGS.....	103

Climate control

PRINCIPLE OF OPERATION	106
AIR VENTS	107
AUTOMATIC CLIMATE CONTROL	107

Convertible top

OPENING THE CONVERTIBLE TOP	113
CLOSING THE CONVERTIBLE TOP.....	118

Convenience features

MEMORY FUNCTION.....	122
INSTRUMENT LIGHTING DIMMER	123
SUN VISORS	123
CLOCK.....	124
CIGAR LIGHTER.....	124
ASHTRAY	124
AUXILIARY POWER SOCKET	125
CUP HOLDERS.....	125
STORAGE COMPARTMENTS.....	126
CENTRE CUBBY BOX	127
PORTABLE AUDIO INTERFACE	127
GARAGE DOOR TRANSCEIVER.....	128

Starting the engine

GENERAL INFORMATION.....	131
KEYLESS STARTING	132
SWITCHING OFF THE ENGINE.....	132

Transmission

AUTOMATIC TRANSMISSION	133
------------------------------	-----

Brakes

PRINCIPLE OF OPERATION	140
HINTS ON DRIVING WITH ABS	140
ELECTRIC PARKING BRAKE (EPB)	142

Parking aid

PRINCIPLE OF OPERATION	143
USING THE PARKING AID.....	143

Driving hints

RUNNING-IN	146
ECONOMICAL DRIVING	147

Contents

Cruise control

PRINCIPLE OF OPERATION	148
USING CRUISE CONTROL	148

Adaptive cruise control (ACC)

PRINCIPLE OF OPERATION	150
USING ACC	150
FORWARD ALERT FUNCTION.....	156

Automatic speed limiter (ASL)

PRINCIPLE OF OPERATION	158
USING THE ASL	159

Driving dynamics

GENERAL INFORMATION	161
WINTER MODE	161
DYNAMIC MODE.....	162
STABILITY CONTROL	162

Fuel and refuelling

SAFETY PRECAUTIONS	166
FUEL QUALITY	166
ALTERNATIVE FUELS	167
RUNNING OUT OF FUEL	168
FUEL FILLER FLAP.....	168
REFUELLING	169
FUEL TANK CAPACITY	170
FUEL CONSUMPTION	171

Load carrying

GENERAL INFORMATION	172
LUGGAGE COVERS (Coupe only).....	172

Vehicle care

CLEANING PRODUCTS	173
CLEANING THE EXTERIOR	173
CLEANING ALLOY WHEELS.....	175
REPAIRING MINOR PAINT DAMAGE	175
CLEANING THE INTERIOR	176

Maintenance

GENERAL INFORMATION	178
SAFETY IN THE GARAGE	180
OPENING AND CLOSING THE BONNET	181
ENGINE COMPARTMENT OVERVIEW.....	182
ENGINE OIL CHECK	183
ENGINE COOLANT CHECK.....	186
BRAKE FLUID CHECK.....	187
POWER STEERING FLUID CHECK	189
WASHER FLUID CHECK.....	190
TECHNICAL SPECIFICATIONS	191

Vehicle battery

BATTERY WARNING SYMBOLS	192
BATTERY CARE	192
BATTERY ACCESS.....	193
USING BOOSTER CABLES.....	194
CHARGING THE VEHICLE BATTERY.....	196
CHANGING THE VEHICLE BATTERY.....	196
EFFECTS OF BATTERY DISCONNECTION	197

Wheels and tyres

GENERAL INFORMATION	198
TYRE CARE	199
TYRE PRESSURES	200
TYRE WEAR	202
USING WINTER TYRES	205
CHANGING A ROAD WHEEL.....	205
TYRE REPAIR KIT.....	210
TYRE PRESSURE MONITORING SYSTEM....	214
USING SNOW CHAINS	218
TYRE GLOSSARY	218
TYRE SPECIFICATIONS - ARDUOUS TERRAIN	219

Fuses

CHANGING A FUSE.....	220
FUSE BOX LOCATIONS.....	221
FUSE SPECIFICATION CHARTS	225

Emergency equipment

HAZARD WARNING FLASHERS.....	229
WARNING TRIANGLE	229
FIRE EXTINGUISHER.....	229
FIRST AID KIT	229

Contents

Status after a collision

DRIVING AFTER A COLLISION	230
ATTEMPTING TO START THE VEHICLE	230
MOVING THE VEHICLE	230
INSPECTING SAFETY SYSTEM COMPONENTS.....	231

Vehicle recovery

TRANSPORTING THE VEHICLE	232
EMERGENCY PARK RELEASE (EPR).....	233
TOWING POINTS.....	235
TOWING ON FOUR WHEELS	236

Vehicle identification

VEHICLE CERTIFICATION LABEL.....	237
VEHICLE IDENTIFICATION NUMBER (VIN)...	237
ENGINE NUMBER	237
TRANSMISSION NUMBER	237
VEHICLE BUILT DATE.....	237

Technical specifications

ENGINE SPECIFICATIONS	238
WEIGHTS.....	238
DIMENSIONS.....	239
WHEEL ALIGNMENT DATA (CHINA ONLY) ..	240

Audio introduction

RADIO RECEPTION.....	241
----------------------	-----

Audio unit overview

AUDIO UNIT OVERVIEW.....	242
--------------------------	-----

Audio unit operation

ON/OFF CONTROL	246
AUDIO CONTROL	246
JAGUAR PREMIUM SURROUND SOUND....	249
WAVEBAND BUTTON	251
AUTOSTORE CONTROL	251
STATION PRESET BUTTONS.....	252
TRAFFIC INFORMATION CONTROL	252

Audio unit menus

RADIO DATA SYSTEM (RDS).....	254
REGIONAL MODE (REG)	256
ENHANCED OTHER NETWORK (RDS-EON).....	256
ALTERNATIVE FREQUENCIES	257

Digital audio broadcasting

GENERAL INFORMATION.....	258
AUDIO CONTROLS	260
DISPLAY OPTIONS	261
CHANNEL AUTOMATIC TUNING	262
CHANNEL OPTIONS	262
PRESET BUTTONS	265
SETTINGS	266

Compact disc player

COMPACT DISC COMPATABILITY	270
LOADING COMPACT DISCS	270
EJECTING COMPACT DISCS	272
COMPACT DISC SELECTION.....	272
TRACK SELECTION	273
COMPACT DISC PAUSE	273
REPEAT COMPACT DISC TRACKS	273
SHUFFLE/RANDOM.....	274
COMPACT DISC DISPLAY OPTIONS.....	274
MP3 FILE PLAYBACK.....	275

Portable audio

PORTABLE AUDIO.....	277
PORTABLE AUDIO DEVICES	279

Telephone

GENERAL INFORMATION.....	284
SAFETY	286
TELEPHONE PAIRING AND DOCKING.....	286
VOICE MAIL	289
ANSWER OPTIONS	290
PHONE OPTIONS	290
PHONEBOOK	291
MAKING A CALL.....	293
NAMES	294
LAST 10 OPTION.....	296
HANDS-FREE CONTROLS	296
OTHER FEATURES	297

Contents

Navigation system

THE NAVIGATION SYSTEM.....	299
SATELLITE SIGNALS.....	299
GETTING STARTED.....	301
MENU STRUCTURE.....	302
MAIN MENU.....	303
USER SETTINGS.....	303
LANGUAGE SELECTION.....	304
MEASUREMENT UNITS.....	304
KEYBOARD LAYOUT.....	304
MAP SPLIT SCREEN.....	305
MAP DISPLAY ICONS.....	306
SEARCH AREA.....	308
SETTING A DESTINATION.....	308
ROUTE PREFERENCES.....	310
START GUIDANCE.....	311
VOICE GUIDANCE.....	312
CANCEL GUIDANCE.....	312
QUICK POI SELECTION.....	313
CALIBRATION.....	313
RESTORE SYSTEM DEFAULTS.....	314
LANGUAGE SELECTION.....	315
STORED LOCATIONS.....	315
AVOID POINTS.....	317
HOME.....	317
DESTINATION ENTRY.....	317
POSTCODE.....	318
MAP.....	318
COORDINATES.....	318
POINTS OF INTEREST (POI).....	319
PREVIOUS.....	319
MOTORWAY.....	320
COMPASS.....	321
POINTS OF INTEREST.....	322
POI ICON DISPLAY.....	322
CANCELLING POI ICON DISPLAY.....	324
JAGUAR DEALERSHIP LOCATIONS.....	324
ENTRY BY TOWN.....	325
ENTRY BY CATEGORY.....	325
OTHER SELECTION METHODS.....	325
CATEGORIES AND SUB-CATEGORIES.....	325
POI ENTRY MESSAGES.....	325
QUICK POI SELECTION.....	326
SELECTING A QUICK POI CATEGORY.....	326
MEMORY POINTS.....	327

RDS-TMC OVERVIEW.....	327
USING TMC.....	329
SURVEILLANCE SETTING.....	331
ORDNANCE SURVEY DATA.....	332
NAVTEQ CORPORATION.....	333
EUROPEAN DECLARATION OF CONFORMITY.....	334

Appendices

TYPE APPROVALS.....	335
---------------------	-----

Introduction

SYMBOLS GLOSSARY

Warnings

WARNING



Safety warnings are included in this handbook. These indicate either a procedure which must be followed precisely, or information that should be considered with great care in order to avoid the possibility of personal injury.

Cautions

CAUTION



Cautions are included in this handbook. These indicate either a procedure which must be followed precisely, or information that should be considered with great care in order to avoid the possibility of damage to your vehicle.

Symbols



This recycling symbol identifies those items that must be disposed of safely in order to prevent unnecessary damage to the environment.



This symbol identifies those features that can be adjusted, disabled or enabled by a Jaguar Dealer/Authorised Repairer.

LABEL LOCATIONS



Warning labels attached to your vehicle bearing this symbol mean:



Do not touch or adjust components until you have read the relevant instructions in the handbook.



Labels showing this symbol indicate that the ignition system utilises very high voltages. Do not touch any ignition components while the starter switch is turned on.



Warning labels

Labels are attached to your vehicle at several positions. These are applied to draw your attention to important subjects, e.g. tyre pressures, airbags, engine compartment hazards, etc.

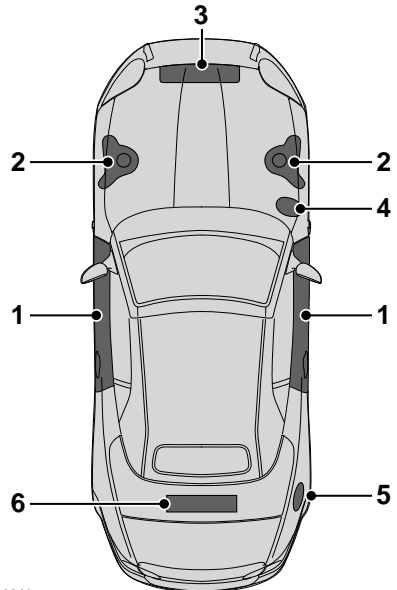

E90641

1. Vehicle certification, Airbag, Child restraint, Tyre placard, E. Approval.
2. Air conditioning.
3. Under bonnet warnings.
4. Coolant warnings.
5. Fuel warnings.
6. Battery.

It is important that you are familiar with these subjects to ensure that your vehicle and its features are used safely. Using the index at the back of this handbook, refer to the relevant topic for more information.

Introduction

FACIA AND CONTROLS

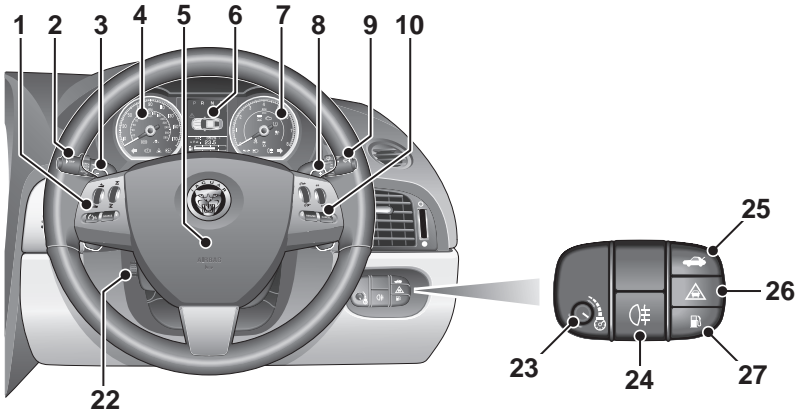
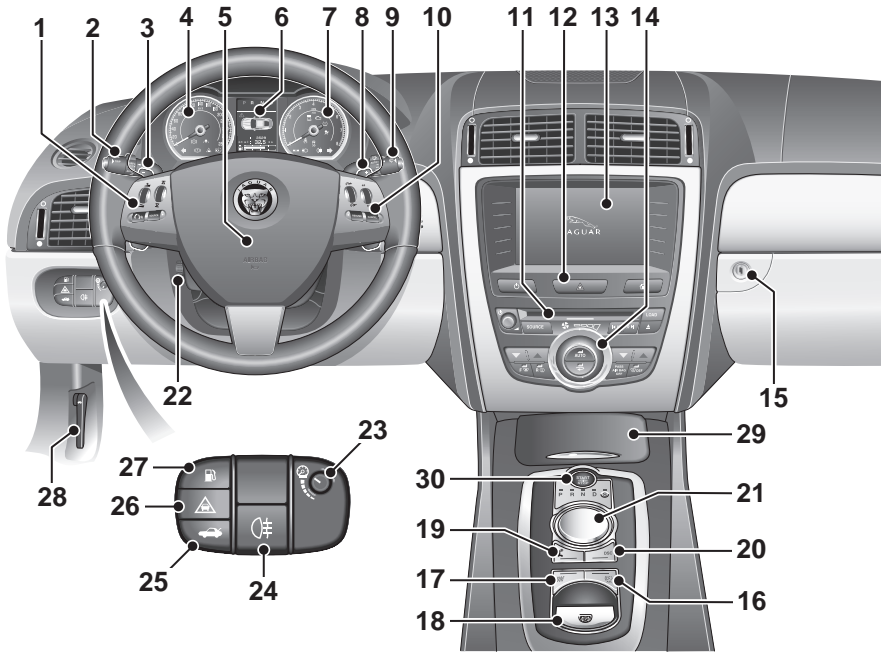

JAG1349

Introduction

1. Steering wheel audio switches. See **AUDIO CONTROL** (page 64).
2. External lamp switches. See **LIGHTING CONTROL** (page 65).
3. Jaguar sequential gear change down paddle. See **AUTOMATIC TRANSMISSION** (page 133).
4. Speedometer. See **INSTRUMENT PANEL OVERVIEW** (page 91).
5. Driver's horn and airbag. See **HORN** (page 63).
6. Message centre. See **GENERAL INFORMATION** (page 97).
7. Tachometer. See **INSTRUMENT PANEL OVERVIEW** (page 91).
8. Jaguar sequential gear change up paddle. See **AUTOMATIC TRANSMISSION** (page 133).
9. Wiper and washer switch. See **WINDSCREEN WIPERS** (page 79).
10. Cruise control or Adaptive Cruise Control switches. See **USING CRUISE CONTROL** (page 148). See **USING ACC** (page 150).
11. Audio panel. See **AUDIO UNIT OVERVIEW** (page 242).
12. Hazard warning switch. See **HAZARD WARNING FLASHERS** (page 68).
13. Touch-screen display. See **TOUCH-SCREEN** (page 101).
14. Climate control panel. See **AUTOMATIC CLIMATE CONTROL** (page 107).
15. Glove box compartment release button. See **STORAGE COMPARTMENTS** (page 126).
16. Automatic Speed Limiter (ASL) switch. See **USING THE ASL** (page 159).
17. Dynamic mode selector switch. See **DYNAMIC MODE** (page 162).
18. Electric parking brake switch. See **ELECTRIC PARKING BRAKE (EPB)** (page 142).
19. Winter mode selector switch. See **WINTER MODE** (page 161).
20. Dynamic Stability Control (DSC) mode switch. See **Driving dynamics** (page 161).
21. Gear selector. See **AUTOMATIC TRANSMISSION** (page 133).
22. Steering column adjustment switch. See **ADJUSTING THE STEERING WHEEL** (page 62).
23. Instrument dimmer switch. See **INSTRUMENT LIGHTING DIMMER** (page 123).
24. Rear fog lamp switch. See **REAR FOG LAMPS** (page 67).
25. Luggage compartment release switch. See **LOCKING AND UNLOCKING FROM OUTSIDE THE VEHICLE** (page 23).
26. Forward alert switch. See **FORWARD ALERT FUNCTION** (page 156).
27. Fuel filler flap release switch. See **FUEL FILLER FLAP** (page 168).
28. Bonnet release lever. See **OPENING AND CLOSING THE BONNET** (page 181).
29. Ashtray and cigar lighter. See **CIGAR LIGHTER** (page 124).
30. Engine start and stop switch. See **KEYLESS STARTING** (page 132).

Introduction

HEALTH AND SAFETY

WARNINGS



The vehicle should not be parked over long dry grass or other combustible material, particularly during dry weather. As the heat generated by the exhaust and emission control systems may be sufficient to start a fire.



Before exiting the vehicle, ensure the **P** park is selected and the parking brake is applied. When exiting the vehicle make sure that the Jaguar Smart Key is removed from the vehicle.

DATA RECORDING

Service data recording

Service data recorders in your vehicle are capable of collecting and storing diagnostic information about your vehicle. This potentially includes information about the performance or status of various systems and modules in the vehicle such as engine, throttle, steering or brakes.

In order to properly diagnose and service your vehicle, Jaguar Cars Limited and service and repair facilities may access vehicle diagnostic information through a direct connection to your vehicle.

Event data recording

Event data recorders are capable of collecting and storing data during a crash or near-crash event. The recorded information may assist in the investigation of such an event. The modules may record information about both the vehicle and the occupants, potentially including information such as:

- How various systems in your vehicle were operating.
- Whether or not the driver and passenger seat belts were buckled.
- How far, if at all, the driver was depressing the accelerator and/or the brake pedal.
- How fast the vehicle was travelling.
- Where the driver was positioning the steering wheel.

To access this information special equipment must be connected directly to the recording modules. Jaguar Cars Limited do not access event data recorder information without obtaining consent, unless pursuant to court order or where required by law enforcement, other government authorities or third parties acting with lawful authority.

Other parties may seek to access the information independently of Jaguar Cars Limited.

DISABILITY MODIFICATIONS

Occupants with disabilities which may require modifications of the vehicle must contact a Jaguar Dealer/Authorised Repairer before any modifications are made.

Introduction

PARTS AND ACCESSORIES

WARNINGS



The fitting of non-approved parts and accessories, or the carrying out of non-approved alterations or conversions, may be dangerous and could affect the safety of the vehicle and occupants and also invalidate the terms and conditions of the vehicle warranty.



Jaguar will not accept any liability for death, personal injury or damage to property which may occur as a direct result of fitment of non-approved accessories or the carrying out of non-approved conversions to Jaguar vehicles.



Jaguar strongly advise against making any modifications to the suspension or steering system. This could seriously affect the handling and stability of the vehicle leading to loss of control or rollover.

The vehicle has been designed, built and tested to cope with a variety of driving conditions, some of which can place the severest possible demands on control systems and components. As such, fitting replacement parts and accessories that have been developed and tested to the same stringent standards as the original components will safeguard the continued reliability, safety and performance of your vehicle.

To augment the vehicle's already impressive performance, a comprehensive range of Jaguar approved spare parts and accessories is available.

Jaguar parts are the only parts built to original equipment specifications and approved by Jaguar designers; this means that every single part and accessory has been rigorously tested by the same engineering team that designed and built the vehicle.

A full list and description of all accessories is available from your Jaguar Dealer/Authorised Repairer.

Electrical equipment

WARNING



It is extremely hazardous to fit or replace parts or accessories, the installation of which requires the dismantling of, or addition to, either the electrical or fuel systems.

Always consult a Jaguar Dealer/Authorised Repairer before fitting any accessory.

Fitting inferior quality parts or accessories, may be dangerous and could invalidate the vehicle warranty.

It is recommended that you always consult a Jaguar Dealer/Authorised Repairer for advice regarding the approval, suitability, installation and use of any parts or accessories before fitting.

Introduction

Airbag system

WARNING



The components that make up the airbag system are sensitive to electrical or physical interference, either of which could easily damage the system and cause inadvertent operation or a malfunction of the airbag module.

To prevent malfunction of the airbag system always consult a Jaguar Dealer/Authorised Repairer before fitting any of the following:

- Electronic equipment such as a mobile phone, two-way radio or in-car entertainment system.
- Accessories attached to the front of the vehicle.
- Any modification to the front of the vehicle.
- Any modification involving the removal or repair of any wiring or component in the vicinity of any of the airbag system components, including the steering column, instrument or fascia panels.
- Any modification to the fascia panels or steering wheel.

After-sales service

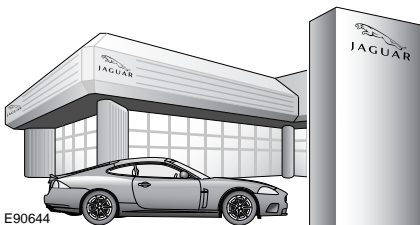

The After Sales Parts service is of paramount importance, with franchised representation in over 100 countries worldwide, Jaguar are able to support your vehicle wherever you go.

Travelling abroad

In certain countries, it is a legal requirement to fit parts made to the vehicle manufacturers' specification.

Owners should ensure that any parts or accessories fitted to the vehicle while travelling abroad will also conform to the legal requirements of their own country when they return home.

Keys and remote controls

PRINCIPLE OF OPERATION

CAUTIONS

- ❗ Remove all Jaguar Smart Keys and emergency key blades from the vehicle when it is left unattended. This will help prevent the alarm being disarmed and therefore help prevent theft.
- ❗ If a remote control is lost, a replacement can be obtained and programmed to the vehicle by a Jaguar Dealer/Authorised Repairer. Notify a Jaguar Dealer/Authorised Repairer as soon as a remote control is lost or stolen and have the remaining remote control(s) reprogrammed.

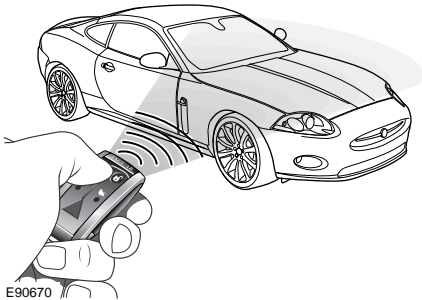

The security system and entry to the vehicle are controlled by the Jaguar Smart Key remote control. Both doors and the luggage compartment can be locked and unlocked using the remote control buttons.

Keyless entry is an enhancement of the Jaguar Smart Key and allows entry to the vehicle, without the need to press a button. Full security integrity of the vehicle is still maintained. See **KEYLESS ENTRY** (page 28).

The Jaguar Smart Key also allows the vehicle to be started without the use of a starter key. See **KEYLESS STARTING** (page 132).

Two handsets are supplied, each incorporating a detachable emergency key blade. Separate emergency key blades are available from Dealers/Authorised Repairers.

The emergency key blade number is recorded on an attached label. Peel off the label and attach it to the designated area on the Security Card, supplied in the literature pack. Keep the Security Card safe, but not in the vehicle.

GENERAL INFORMATION ON RADIO FREQUENCIES

Note: *The radio frequency used by your Jaguar Smart Key may be used by other devices. For example: amateur radios, medical equipment, wireless headphones or other remote control devices. This may cause the frequency to be jammed, and prevent your Jaguar Smart Key from operating correctly.*

Environmental conditions can affect the operation of remote controls and the operating range may vary considerably, depending on the vehicle's location.

Keys and remote controls

USING THE JAGUAR SMART KEY

WARNING



Never leave the Jaguar Smart Key in the vehicle if children or animals are also left in the vehicle. The vehicle's systems and remote control functions could be operated, which may result in injury.

Note: The operational range of the Jaguar Smart Key will vary considerably, depending on atmospheric conditions and interference from other transmitting devices.

Note: Some features of the security system are market dependent or are options, so may not be present on your vehicle.

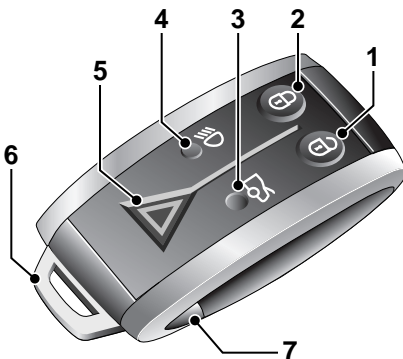

E90683

1. Unlock.
2. Lock.
3. Luggage compartment release.
4. Convenience headlamp feature.
5. Panic alarm.
6. Emergency key blade.
7. Emergency key blade release button.

Unlocking



Press to unlock. See **UNLOCKING AND DISARMING THE VEHICLE** (page 17).

Locking



Press to lock. See **LOCKING AND ARMING THE VEHICLE** (page 18).

Luggage compartment



Press to unlock, disarm and open the luggage compartment. The vehicle security system will remain active, but for the period the luggage compartment is open, the intrusion and inclination sensing systems will be inhibited. Door and bonnet security will remain active.

When the luggage compartment is subsequently closed, the hazard warning lamps will flash after a few seconds, to confirm that the vehicle has rearmed the full alarm system (if previously armed).

Approach lamps



When approaching the vehicle in the dark, press to switch on the approach illumination. The headlamps will illuminate for up to 25 seconds. Pressing the button again or operating the starter button, will turn the approach lamps off.

Keys and remote controls

Panic alarm



Press and hold for three seconds, or press three times within three seconds, to activate the emergency alarm. The horn and hazard warning lamps will operate.

Once active for more than five seconds, the alarm can be cancelled by pressing and holding the button for three seconds.

The emergency alarm will also be cancelled if the Jaguar Smart Key is inserted into the starter control unit and the starter button is pressed, or if the vehicle detects a valid Jaguar Smart Key when the starter button is pressed.

Care of the Jaguar Smart Key

CAUTIONS



Do not expose the Jaguar Smart Key to extremes of heat, dust, humidity or allow contact with fluids.



Do not leave the Jaguar Smart Key exposed to direct sunlight.

Irregular operation

If difficulty is experienced with remote keyless entry, keyless entry, keyless starting or Jaguar Smart Key operation, it may be caused by:

- Internal battery low voltage. Replace the battery. See **CHANGING THE REMOTE CONTROL BATTERY** (page 21).
- High levels of localised external electrical interference, e.g. a radio transmitter.

Until the Jaguar Smart Key battery can be replaced, or until the vehicle is outside the area of electrical interference, the Jaguar Smart Key should be inserted into the starter control unit. See **DOCKING/UNDOCKING THE JAGUAR SMART KEY** (page 18).

UNLOCKING AND DISARMING THE VEHICLE



Your vehicle can be unlocked using either Single or Multi-point entry.

Single-point entry is a security feature that only unlocks the driver's door when the unlock button is pressed.

To change from single to multi-point entry (or vice versa), press both the lock and unlock buttons on the Jaguar Smart Key simultaneously for three seconds. The hazard warning lamps will flash twice to confirm the change. The change can also be achieved using the vehicle touch-screen. See **PROGRAMMING THE REMOTE CONTROL** (page 20).

Single-point entry

First press: Unlocks the driver's door and enables the passenger door to be opened from the inside. The hazard warning lamps will flash twice to indicate that the vehicle is unlocked and the alarm has been disarmed. The interior lamps will illuminate to assist entry to the vehicle.

Second press: Unlocks the passenger door and the luggage compartment.

Multi-point entry

Press briefly to unlock the doors and luggage compartment and to disarm the alarm. The hazard warning lamps will flash twice to indicate that the vehicle is unlocked and the alarm has been disarmed. The interior lamps will illuminate to assist entry to the vehicle.

Global open

Press and hold the unlock button to open all the windows on the vehicle.

Keys and remote controls

LOCKING AND ARMING THE VEHICLE

CAUTION

 The vehicle will only lock, if all door, luggage compartment and bonnet apertures are closed. If a lock attempt is made when an aperture is open, the vehicle will not lock and two audible error warnings will sound.



Press and release the lock button to lock the vehicle and arm the alarm.

The doors are prevented from being opened from outside of the vehicle. The doors can be unlocked and opened from inside the vehicle. The hazard warning lamps will flash once as confirmation.

Press the lock button twice within three seconds to double-lock all the doors and set the alarm system to provide the highest level of security - use this method whenever possible.

Note: When the vehicle is double locked, the interior door handles are immobilised.

WARNING



Never double-lock the vehicle when someone is to remain inside the vehicle. In an emergency, they would not be able to open the doors.

Global close

Press and hold the lock button to close all the windows on the vehicle.

Automatic relocking

If a door or the luggage compartment are not opened within 40 seconds of unlocking the vehicle using the Jaguar Smart Key, the doors will lock again automatically. This feature can be enabled/disabled using the touch-screen. See **PROGRAMMING THE REMOTE CONTROL** (page 20).

DOCKING/UNDOCKING THE JAGUAR SMART KEY

Docking the Jaguar Smart Key

During normal operation, it is not necessary to dock the Jaguar Smart Key. However, if the unlock button on the Smart Key fails to operate and the vehicle has been unlocked using the emergency key blade, it will be necessary to dock the Jaguar Smart Key, to deactivate and disarm the alarm system.

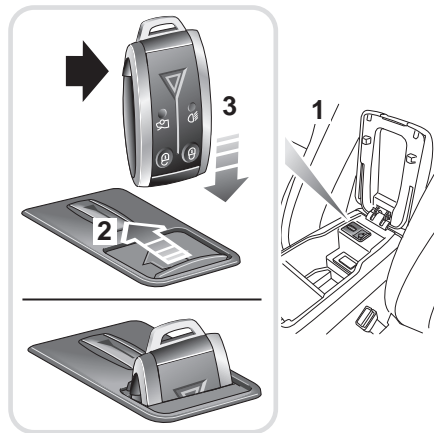

JAG1350

1. Lift the lid of the centre console stowage compartment.
2. Slide open the cover of the starter control unit.
3. Insert the Jaguar Smart Key into the recess with the emergency key release button facing forward.

Note: This is not a Jaguar Smart Key internal battery recharging procedure. The battery is non-rechargeable.

Keys and remote controls

Undocking the Jaguar Smart Key

CAUTION

⚠ Ensure the engine is switched off before undocking the Jaguar Smart Key, otherwise damage to the Smart Key may occur.

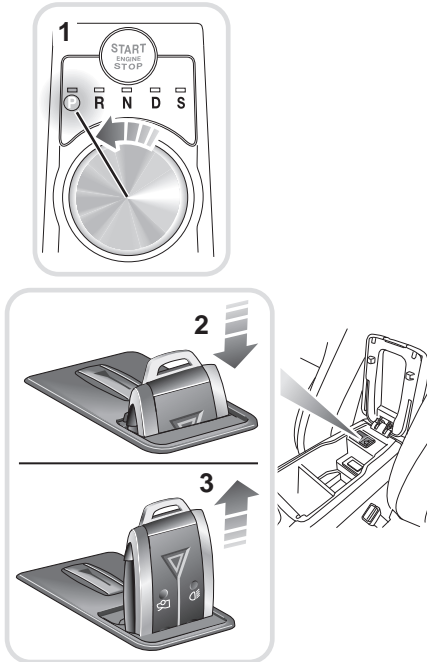

JAG1351

To remove the Jaguar Smart Key from the starter control unit:

1. Ensure that the vehicle is at rest with the gear selector in the **P** position and the engine not running.
2. Carefully depress the Jaguar Smart Key and release. The key will eject into its rest position.
3. Remove the Jaguar Smart Key from the starter control unit.

Message centre information displays

Message	Meaning
SMART KEY NOT FOUND, PLEASE INSERT IN SLOT	The Jaguar Smart Key has not been detected, insert into the starter control unit.
CHECK SMART KEY	Check that the Jaguar Smart Key is in the vehicle.
WRONG SMART KEY FOUND	The Jaguar Smart Key detected by the in-vehicle systems is not the one belonging to the vehicle.
REMOVE SMART KEY	Remove the Jaguar Smart Key from the starter control unit.

Keys and remote controls

PROGRAMMING THE REMOTE CONTROL

The Jaguar Smart Key, and various features of the vehicle security system, can be programmed to your individual requirements by use of the touch-screen.

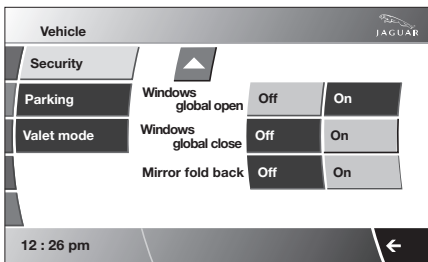
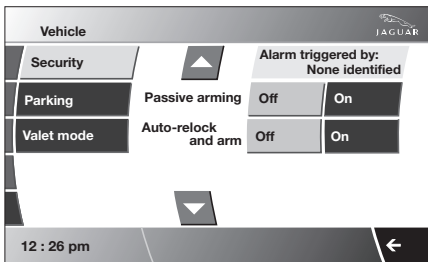
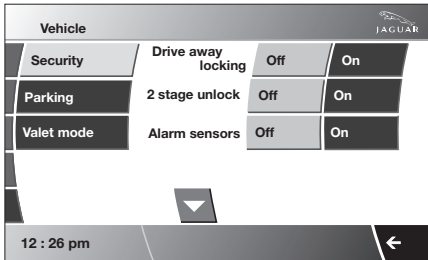

JAG1452

To access the programmable features, select **Vehicle** from the Home menu, then select **Veh. settings**. The **Security** menu is displayed automatically as the default.

The Security menu consists of 3 screens. Use the arrow buttons to scroll to the desired entry.

The programmable features are as follows:

- Drive-away locking.
- Central or two stage locking.
- Sensor override.
- Window global open or close (passive entry vehicles only).
- Valet mode. See **VALET MODE** (page 26).
- Passive arming.
- Automatic relock and arm.

Selecting drive-away locking

- Select the arrow button to scroll down to **Drive away locking** and select either **On** or **Off**.

Setting the drive-away locking speed

Once **Drive away locking On** is selected, select the speed from the list at which you want the locks to activate (8, 16 or 32 km/h or 5, 10 or 20 mph). To change between Imperial and Metric measurement units, select **Units**.

Selecting single (2 stage unlock) or multi-point entry

- Select **2 stage unlock On** (for single-point entry) or **Off** (for multi-point entry).

***Note:** This selection changes the setting for both keyless entry and for when unlocking using the Jaguar Smart Key.*

Selecting alarm sensor override

- Select **Alarm sensors Off** or **On**.

This will override the interior and tilt alarm sensors until the engine is next started. It is normally used for recovery of the vehicle or when travelling on a ferry.

Selecting global opening or closing

- Scroll down to **Global open** or **Global close** and select either **On** or **Off**.

Keys and remote controls

Selecting passive arming

- Scroll down to **Passive arming** and select either **On** or **Off**.

Selecting automatic relock and arm

- Scroll down to **Auto-relock and arm** and select either **On** or **Off**.

CHANGING THE REMOTE CONTROL BATTERY

Battery renewal

When the battery needs renewing, there will be a significant decrease in the effective range of the Jaguar Smart Key transmitter and the message **SMART KEY BATTERY LOW** is displayed in the message centre.

To renew the battery:

1. Remove the key blade from the Jaguar Smart Key. See **USING THE JAGUAR SMART KEY** (page 16).
2. Remove the two side covers, one at a time, by inserting a small, flat-bladed, screwdriver between the cover and body and twist the screwdriver.
3. Insert a small, flat-bladed, screwdriver between the two body halves of the remote handset. Apply light pressure to the screwdriver and separate the two halves.
4. Remove the printed circuit board, taking care not to touch the battery terminals. Remove the old battery and dispose of it safely.
5. Fit a new battery cell, type CR2032 (available from your Jaguar Dealer/ Authorised Repairer), with the side marked with the positive symbol (+) downwards in the battery receptacle. Avoid touching the new battery as moisture and oil from the fingers can reduce the life of the battery and corrode the contacts.

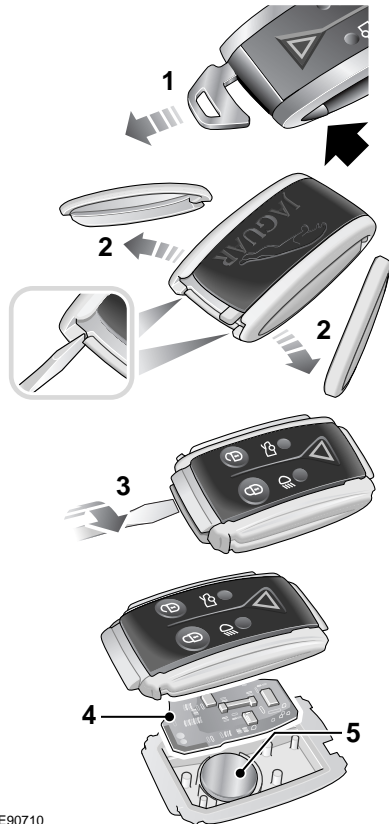

E90710

Refit the parts in the reverse order making sure that they click securely into place.

Battery disposal



Used batteries must be disposed of correctly, as they contain a number of harmful substances. Seek advice on disposal from your Dealer and/or your local authority.

Keys and remote controls

EMERGENCY KEY BLADE

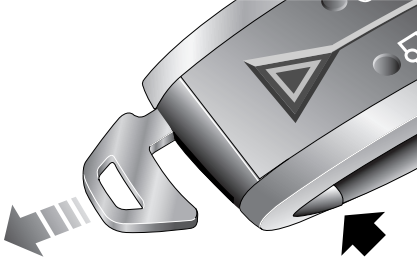

E90689

To extract: Press and hold the release button (arrowed) while pulling the key blade from the Jaguar Smart Key body.

To insert: Press and hold the release button while pushing the key blade into the appropriate slot in the Jaguar Smart Key.

The key blade operates the left-hand door lock, the luggage compartment lock and glove compartment lock. See **USING THE EMERGENCY KEY BLADE** (page 24).

Locks

LOCKING AND UNLOCKING FROM OUTSIDE THE VEHICLE

Locking and unlocking the vehicle using the Jaguar Smart Key is explained earlier in this handbook. See **USING THE JAGUAR SMART KEY** (page 16).

Locking and unlocking the vehicle using the Keyless Entry system is explained later in this section. See **KEYLESS ENTRY** (page 28).

Note: To help prevent locking the Jaguar Smart Key inside the vehicle, it has been made difficult to slam lock a door using the interior locking lever. The door will not lock.

Luggage compartment

CAUTION

! If the luggage compartment is opened after the driver and passenger doors are locked, ensure that the Jaguar Smart Key remains outside the vehicle when it is closed again. If the Jaguar Smart Key is inadvertently left inside the luggage compartment, an audible warning will sound and the luggage compartment will re-open after three seconds.

Note: If the Jaguar Smart Key is placed within a metal box, it will not be detected by the vehicle security system.

The luggage compartment can be opened from outside the vehicle, even if the alarm is armed and the doors are locked, by pressing the luggage compartment button on the Jaguar Smart Key, by using keyless entry or by using the emergency key blade, as described later in this section.

If the alarm is disarmed and the doors are unlocked, the luggage compartment can also be opened using the interior or exterior release buttons.

Drive-away locking

This feature locks all unsecured doors when the vehicle reaches a designated forward speed. This designated speed and whether or not drive-away locking is enabled, can be set using the touch-screen. See **PROGRAMMING THE REMOTE CONTROL** (page 20).

LOCKING AND UNLOCKING FROM INSIDE THE VEHICLE

Door lock and release levers

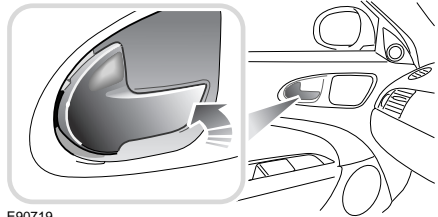

- Press the door release lever inwards to lock the door. If both doors are closed, operating the locking lever on either front door will lock both doors and the luggage compartment.
- Pull the door release lever to unlock the door. If the doors were locked from the inside and the alarm is disarmed, operating the locking lever on either front door will unlock both doors.

If the vehicle was locked using the Jaguar Smart Key, operating the lever will unlock the selected door, but will also set off the alarm.

- Pull the release lever to open a door. If the doors are locked, operating the lever will unlock and open the door.

Locks

Luggage compartment



JAG1423

Press to open the luggage compartment.

Mislock

If one of the doors, the bonnet or the luggage compartment are not shut fully when the vehicle is locked using the Jaguar Smart Key, two audible error warnings will sound. Ensure that all apertures are properly closed and attempt to lock the vehicle again.

If one or both doors fail to lock properly when a lock attempt is made using the Jaguar Smart Key, two audible error warnings will sound and one or more of the doors may not be locked.

If the ignition is left on when the vehicle is locked using the Jaguar Smart Key, two audible error warnings will sound.

USING THE EMERGENCY KEY BLADE

The emergency key blade will be needed to unlock the vehicle if the Jaguar Smart Key has a discharged battery or is damaged. The emergency key blade is also used for accessing the luggage compartment if the vehicle has been left in Valet mode. Withdraw the key from the Jaguar Smart Key for use. See **EMERGENCY KEY BLADE** (page 22).

Locking and unlocking the doors

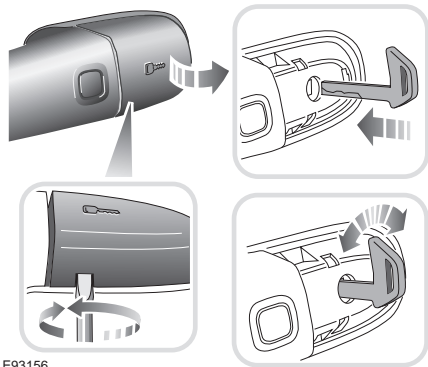

E93156

Remove the left-hand door lock cover as follows:

1. Insert the emergency key blade into the slot on the underside of the cover.
2. Gently lever the key blade upwards.
3. Carefully twist the key blade, to lever the cover off the retaining clips.

Insert the key blade into the exposed lock to operate.

Note: To refit the door lock cover, push it firmly back into place until it clicks into position.

To lock: Ensure all the doors are closed, then turn the key blade towards the front of the vehicle and release. This will lock the doors, but will not arm the alarm.

Locks

To unlock: Turn the key blade towards the rear of the vehicle and release. If the security system is disarmed, the doors and luggage compartment will be unlocked. If the security system is armed, only the front left-hand door will unlock. The interior lighting will be turned on at a reduced level for two minutes.

If the vehicle is unlocked using the key blade with the security system armed, the alarm will sound when a door is opened. To deactivate the alarm, press the unlock button on the Jaguar Smart Key or press the engine starter button with the Smart Key inside the vehicle.

If the Jaguar Smart Key is inoperable, the alarm can be deactivated by docking the Smart Key into the starter control unit. See

DOCKING/UNDOCKING THE JAGUAR SMART KEY (page 18).

Unlocking the luggage compartment

If Valet mode is selected, or if the vehicle battery is discharged, it will be necessary to use the emergency key blade to unlock and open the luggage compartment.

Note: *If the security system is in Valet mode, the touch-screen can be used to cancel Valet mode, in which case, the luggage compartment can then be opened in the normal manner.*

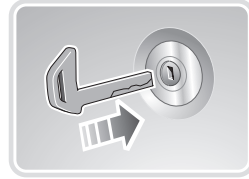
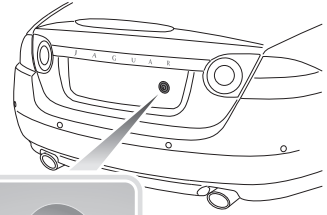

JAG1424

The luggage compartment emergency key barrel is located behind the rear license plate. With the license plate removed, insert the emergency key blade and turn the key clockwise to unlock and open the luggage compartment.

Note: *If the alarm is armed when the emergency key blade is used to unlock the luggage compartment, the alarm will sound when the luggage compartment is opened. Press the unlock button on the Jaguar Smart Key to disarm/deactivate the alarm.*

Note: *Unlocking the luggage compartment using the emergency key blade, will cancel Valet mode.*

Locks

VALET MODE

Valet mode allows the vehicle to be locked by a parking attendant, without giving access to the luggage compartment and glove compartment.

Valet mode also prevents operation of the touch-screen, to prevent access to telephone numbers and navigation addresses.

Selecting valet mode

From the touch-screen Home menu, select **Valet**:

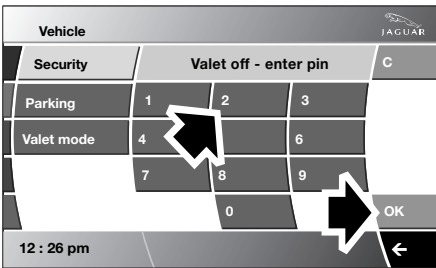

Enter your personally chosen, four-digit Personal Identification Number (PIN), using the keypad on the touch-screen. Select **OK**.

If you want to cancel the PIN or if an incorrect number is entered, touch the **C** button at any time while entering the number.

Once the PIN has been entered, a pop-up screen is displayed, advising you to remove the emergency key blade from the Jaguar Smart Key and to keep it safe. Select **OK**. The screen will indicate that the PIN has been accepted by displaying **Valet on**.

The luggage and glove compartments are now securely locked in Valet mode. On exiting and securing the vehicle, hand the Jaguar Smart Key, with the emergency key blade removed, to the attendant.

Note: Ensure that the emergency key blade is kept safely at all times.

Deselecting valet mode

When entry into the vehicle has been gained, the Valet mode screen will be displayed automatically. Enter your four-digit PIN and select **OK**.

A pop-up screen is displayed, advising you to return the emergency key blade to the Jaguar Smart Key. Select **OK**; the screen will indicate that your PIN has been accepted by displaying **Valet off**.

- The luggage compartment will return to the previously set security status.
- The glove compartment can now be opened as normal.

Note: If the PIN number has been forgotten, the luggage compartment can be unlocked using the emergency key blade. This will also cancel Valet mode.

Locks

JAGUAR SMART KEY SYSTEM TRANSMITTERS

WARNING



Any person fitted with an implanted medical device should ensure that the device is kept at a distance of at least 22 cm (8.7 inches) away from any transmitter mounted in the vehicle. This is to avoid any possibility of interference between the system and device.

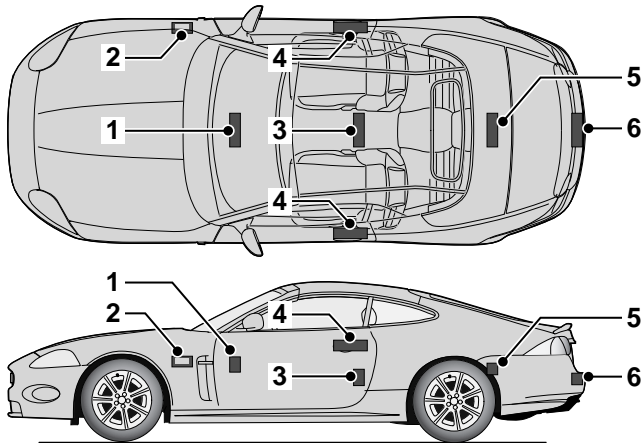

E90692

1. Cabin front transmitter.
2. Keyless vehicle module.
3. Cabin rear transmitter.
4. Exterior door handle transmitters.
5. Luggage compartment interior transmitter.
6. Luggage compartment exterior transmitter.

Locks

KEYLESS ENTRY

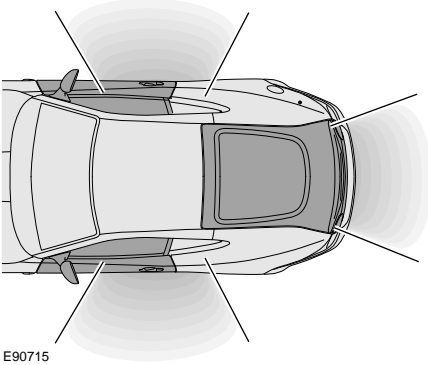

E90715

Keyless entry allows the driver to unlock and disarm the vehicle by simply operating the door handle. The keyless entry function operates as follows:

- As a door handle is operated, the vehicle emits a search signal.
- If a valid Jaguar Smart Key is within approximately 1.0 metre (3 feet) of the operated door handle, the signal will be acknowledged.
- The vehicle recognises the Jaguar Smart Key and disarms the alarm and unlocks the vehicle according to the current security setting (either single-point or multi-point entry). See **USING THE JAGUAR SMART KEY** (page 16). The hazard warning lamps flash twice as confirmation.

Note: The Jaguar Smart Key needs only to be on the driver's person or in a non-metallic bag or briefcase. It does not need to be exposed or handled.

Note: If single-point entry is the current security setting and the passenger's door is opened first, both doors will be unlocked. If the driver's door is opened, only the driver's door will be unlocked. All other doors and the luggage compartment will remain locked.

Jaguar Smart Key check

When the last open door is closed, the vehicle will perform a search of the vehicle interior for the Jaguar Smart Key. If one is not found, **SMART KEY NOT FOUND, PLEASE INSERT IN SLOT** will be displayed in the message centre for four seconds. This is to alert the driver that the Jaguar Smart Key may have been inadvertently been removed from the vehicle.

Keyless locking

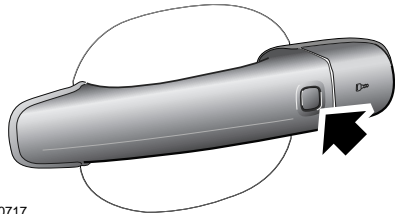

E90717

The vehicle will not lock automatically.

The vehicle will only lock if both doors, the luggage compartment and the bonnet are closed. If a lock attempt is made with an open aperture, the vehicle will not lock and two audible error warnings will sound.

To lock the vehicle, press the button on the door handle. The hazard warning lamps will flash once as confirmation.

Note: Keyless locking will only activate if the Jaguar Smart Key is outside the vehicle. If no Smart Key is present, two audible error warnings will sound.

Locks

Window global closing

Press and hold the button on the door handle for three seconds, to lock the vehicle, arm the alarm and also close all open windows. The windows will stop closing when the button is released.

Convenience mode

When the door is opened using either the Jaguar Smart Key or keyless entry, the vehicle's electrical system initiates the convenience mode. The following systems become functional:

- Memory.
- Seat and steering column adjustment.
- Interior and exterior lighting.
- Message centre.
- Auxiliary power socket.

GLOBAL OPENING AND CLOSING

WARNINGS



Accidental closing of an electrically operated window on fingers, hands or any vulnerable part of the body, can result in serious injury.



Make sure that you have a clear view of all open apertures on the vehicle and that all apertures are unobstructed, before activating the global closing.

Global opening and closing is enabled/disabled via the touch-screen. See **PROGRAMMING THE REMOTE CONTROL** (page 20).

Window global opening

Window Global open can be performed by pressing and holding the unlock button on the Jaguar Smart Key. This can be cancelled by pressing any button on the Smart Key while the windows are moving.

Window global closing

Window global close can be performed by pressing and holding the lock button on the Jaguar Smart Key. This can be cancelled by pressing any button on the Smart Key while the windows are moving.

Alternatively, press and hold the exterior locking button on the driver's door handle for at least three seconds (with a valid Jaguar Smart Key in the vicinity of the door) until all the windows are closed.

Note: *The windows will stop closing when the lock button is released.*

Cancelling window global open/close

To stop the windows from opening/closing during a global open/close, press any of the buttons on the Jaguar Smart Key or operate the driver's window switch. To stop a particular window from opening/closing, operate the relevant window switch.

Alarm

ARMING THE ALARM

Some security features may not be available on your vehicle or in your market. You should contact your Jaguar Dealer/Authorised Repairer if you are unsure.

The engine is automatically immobilised when the Jaguar Smart Key is removed from the vehicle. The perimeter alarm system is armed when the lock button on the Jaguar Smart Key is pressed or the button on the exterior door handle is pressed with a valid Jaguar Smart Key in close proximity. The hazard lamps will flash to indicate that the alarm is armed (in certain markets, an audible tone will sound).

The alarm can arm automatically (known as passive arming) 60 seconds after the doors, luggage compartment and bonnet apertures are closed and the Jaguar Smart Key is removed from the vehicle. **Passive arming does not lock the vehicle.**

This feature can be enabled/disabled using the touch-screen. See **PROGRAMMING THE REMOTE CONTROL** (page 20).

Full alarm

To set full alarm protection, ensure that all the windows are closed. Press the lock button twice within three seconds. The hazard lamps will flash twice to confirm the alarm state and an audible alarm tone will sound to confirm the vehicle is double-locked.

Once fully armed, the alarm will sound if:-

- The bonnet, luggage compartment or a door are opened.
- Movement is detected within the vehicle interior (intrusion sensing).
- A window or front or rear screen are broken.
- The vehicle is raised or tilted (inclination sensing).

- The vehicle battery is disconnected (battery-backed sounder).
- An attempt is made to disconnect the alarm siren (battery-backed sounder).
- An attempt is made to start the vehicle without a valid Jaguar Smart Key present.

Note: *If the alarm is fully armed and a window or the convertible roof are left open, the alarm may sound due to movement of air currents.*

Partial (perimeter) alarm

The perimeter alarm system is armed when the lock button on the Jaguar Smart Key is pressed or the button on the exterior door handle is pressed with a valid Smart Key in close proximity. The hazard lamps will flash to indicate that the alarm is armed (in certain markets, an audible tone will sound).

Once partially armed, the alarm will sound if:-

- The bonnet, luggage compartment or either door is opened.
- The vehicle battery is disconnected (battery-backed sounder).
- An attempt is made to disconnect the alarm siren (battery-backed sounder).
- An attempt is made to start the vehicle without a valid Jaguar Smart Key present.

Note: *The partial alarm should be used in circumstances where people/pets are to be left in the vehicle or when a window is to be left open. Also, use the partial alarm when transporting the vehicle by train or ferry, to prevent the inclination sensor from arming.*

Alarm

Alarm indicator

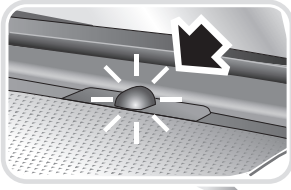

JAG1431

The alarm status is displayed by the indicator:

- Indicator off - alarm disarmed.
- Indicator flashes once per second - alarm is armed and engine immobilised.

Passive arming

This vehicle is fitted with a passive arming feature which can, if enabled, automatically arm the anti-theft system. Passive arming will automatically arm the alarm system 60 seconds after the driver's door is closed, provided the passenger door, bonnet and luggage compartment are closed, the ignition is switched off and there are no valid Jaguar Smart Keys inside the vehicle.

It will also automatically arm the alarm system 60 seconds after the vehicle is unlocked, if neither door or the luggage compartment are opened.

Passive arming will not lock the vehicle, although access to the luggage compartment via the interior or exterior release buttons, will be inhibited and the fuel filler flap will be locked. Passive arming can be enabled/disabled using the touch-screen. See **PROGRAMMING THE REMOTE CONTROL** (page 20).

Automatic relock and arm

This is a feature which, if enabled, automatically relocks the vehicle and arms the anti-theft system.

if the vehicle is in a locked and armed state and the remote unlock button is pressed, but neither of the doors or the luggage compartment are opened within 40 seconds, the vehicle will automatically relock both doors and the luggage compartment and will re-arm the alarm system.

Automatic relock and arm can be enabled/disabled using the touch-screen. See **PROGRAMMING THE REMOTE CONTROL** (page 20).

DISARMING THE ALARM

When the vehicle is unlocked using the Jaguar Smart Key or by valid keyless entry, the alarm is automatically disabled. The hazard lamps will flash twice to indicate that the alarm is disabled.

Disarming when the unlock button fails to work

If, when pressed, the unlock button fails to operate, the vehicle can still be unlocked and the alarm disabled. To unlock the vehicle:-

1. Unlock the left-hand door using the emergency key blade. See **USING THE EMERGENCY KEY BLADE** (page 24).
2. Dock the Jaguar Smart Key into the starter control unit. See **DOCKING/UNDOCKING THE JAGUAR SMART KEY** (page 18).

Note: When the left-hand door is unlocked using the key, the alarm will sound until the Jaguar Smart Key is docked into the starter control unit.

Alarm

Deactivating the alarm when triggered

If the alarm has been triggered, it can be deactivated by any one of the following methods.

- Press the unlock button on the Jaguar Smart Key.
- Dock the Jaguar Smart Key into the starter control unit.
- Open a door using keyless entry.
- Press the START/STOP button with a valid Jaguar Smart Key present.

Battery-backed sounder

In certain markets a separate, self-contained, battery-backed sounder is fitted. This device will sound the full alarm if the vehicle alarm is activated or if the vehicle battery or the sounder is disconnected when the security system is armed.



The battery-backed sounder contains a battery and must be disposed of correctly, as it contains a number of harmful substances. Seek advice on disposal from your Dealer/Authorised Repairer and/or your local authority.

TILT SENSOR

The tilt sensor detects any change in the vehicle's inclination to the ground. When the alarm is armed and the vehicle double-locked, any change in the vehicle's inclination will activate the alarm. This feature protects against unauthorised towing away or jacking up of the vehicle.

The tilt alarm is disarmed when the vehicle security system is disarmed using the Jaguar Smart Key.

Note: If the vehicle is being transported by road, rail or sea, the vehicle should not be double-locked. Sensor override functionality should be used via the touch-screen. See **PROGRAMMING THE REMOTE CONTROL** (page 20). This prevents the tilt sensor from being activated and sounding the alarm as the vehicle pitches and rolls.

INTRUSION SENSOR

The intrusion sensor is located in the centre console and detects any movement within the vehicle cabin, via the use of microwaves. When the alarm is armed and the vehicle double-locked, any movement detected inside the cabin will activate the alarm.

The luggage compartment can still be unlocked using the Jaguar Smart Key, without sounding the alarm.

Note: It takes approximately 30 seconds after the alarm is armed, for the sensor to create a profile of the cabin and be fully armed.

Note: Ensure all windows and the convertible roof are closed prior to setting the intrusion sensor. Failure to do so may result in false alarms being sounded due to movement detected outside the vehicle.

SENSOR FAULTS

If the security system detects a fault with one of the security sensors, it will indicate this condition by emitting two error tones from the alarm siren, after the vehicle is unlocked and disarmed. If this condition occurs, consult your Dealer/Authorised Repairer, to have the fault rectified.

Seats

SITTING IN THE CORRECT POSITION

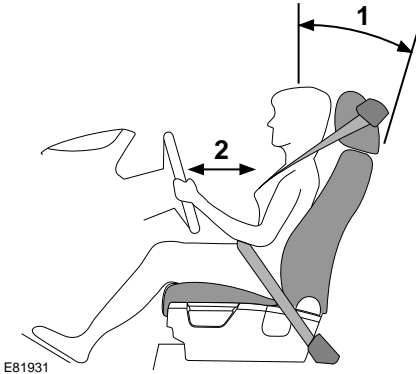

2. Do not move the driver's seat too close to the steering wheel. Ideally, a minimum distance of 254 mm (10 inches) is recommended between the breastbone and the steering wheel airbag cover. Hold the steering wheel in the correct position with your arms slightly bent.
 - Adjust the head restraint so that its highest point is level with the top of your head.
 - Position the seat belt so that it is mid way between your neck and your shoulder. Fit the strap tightly across your hips, not across your stomach.
 - Ensure that your driving position is comfortable, and enables you to maintain full control of the vehicle.

WARNINGS



An inflating airbag may cause serious injury or death if the seats are positioned, or adjusted incorrectly.



Adjust the head restraint so that it is behind your head and never behind your neck.



Do not adjust the seat while the vehicle is moving. Doing so could cause loss of vehicle control and personal injury.



Driver and front seat passenger should always move their seats as far rearwards as is practical.

The seat, head restraint, seat belt and airbags, all contribute to the protection of the user. Correct use of these components will give you greater protection, therefore you should observe the following points:

1. Sit in an upright position with the base of your spine as far back as possible and the seatback reclined no more than 30 degrees.

Seats

ELECTRIC SEATS

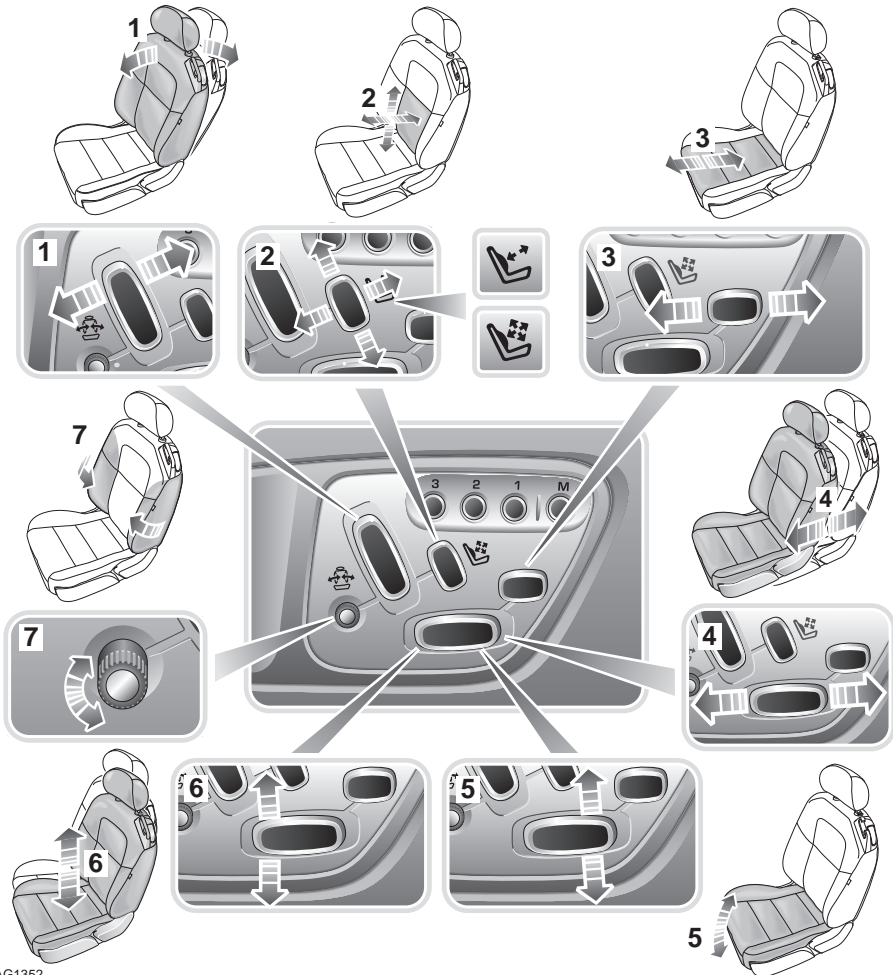

JAG1352

1. Seat back angle adjustment.
2. Lumbar support adjustment.
3. Cushion length adjustment.
4. Fore and aft adjustment.
5. Cushion front tilt adjustment.
6. Height adjustment.
7. Side bolster support adjustment.

Seats

WARNINGS



Do not adjust the seat while the vehicle is moving. Failure to follow this instruction could potentially cause personal injury or loss of vehicle control.



Do not travel with the seatbacks reclined steeply rearwards. Optimum benefit is obtained from the seat belt with the seatback angle set to no more than 30 degrees from the upright (vertical) position. Failure to maintain the correct seatback angle will reduce the effectiveness of the seat belts and increase the risk of serious injury or death in a crash.



Do not wedge objects (e.g. luggage) between the front seat backrest and the rear seat cushion.

The front seats are adjusted by switches on the door.

Seat adjustments for three people may be stored and recalled by the driver position memory system. See **MEMORY FUNCTION** (page 122).

Lumbar support

Depending on the options fitted to your vehicle, the lumbar support is controlled as follows:

Two-way adjustment: Push upwards to increase lumbar support. Push downwards to reduce.

Four-way adjustment:

- Push upwards to increase upper lumbar support.
- Push downwards to increase lower lumbar support.
- Push forwards to increase both upper and lower lumbar support.
- Push rearwards to decrease both upper and lower lumbar support.

Seatback tilt



E90762

The front seats tilt forward to allow access to the rear seats.

To tilt the seat forward: Remove the seat belt from the seat belt guide. Lift the lever and push the seatback forwards to allow easy access. The seatback will latch when returned to the up-right position. Make sure that the seat belt is returned to the seat belt guide. See **FASTENING THE SEAT BELTS** (page 41).

Seats

HEAD RESTRAINTS

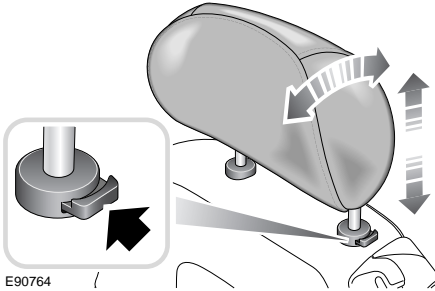

Each head restraint can be adjusted to give the correct height for the seat occupant. They may also be tilted.

- **To lower:** Press the button inwards and push the head restraint into the seatback to the required height.
- **To raise:** Pull the head restraint upwards.
- Swivel the head restraint forwards or backwards until it is comfortably positioned behind your head.

WARNINGS



Head restraints are designed to support the head, not the back of the neck. The restraint must be positioned correctly to restrain rearward movement of the head in a collision. An incorrectly adjusted head restraint increases the risk of death or serious injury in the event of a collision.



Adjust the head restraint so that the top of the head restraint is above the centre line of the head. An incorrectly adjusted head restraint increases the risk of death or serious injury in the event of a collision. See **SITTING IN THE CORRECT POSITION** (page 33).



Do not drive, or carry passengers with the head restraints removed from occupied seats. The absence of a correctly adjusted head restraint increases the risk of death or serious injury in the event of a collision.



Never adjust the head restraints while the vehicle is in motion. An incorrectly adjusted head restraint increases the risk of death or serious injury in the event of a collision.

Seats

HEATED SEATS

The front seat heating is activated via the touch-screen main Home menu or the Climate menu.

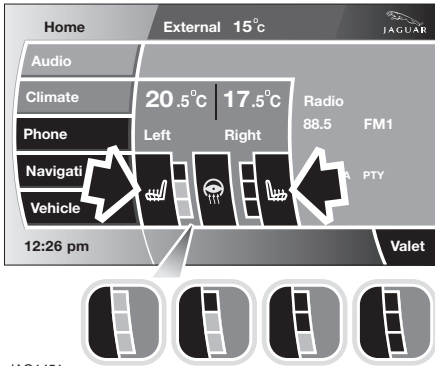

JAG1451

From the main Home menu, select either the left-hand or right-hand seat icon and repeatedly press to adjust for the required temperature. With the engine running, first press is fully on.

From the **Climate** main touch-screen select either left-hand or right-hand seat icon and repeatedly press to adjust for the required temperature. With the engine running, first press is fully on.

CLIMATE SEATS

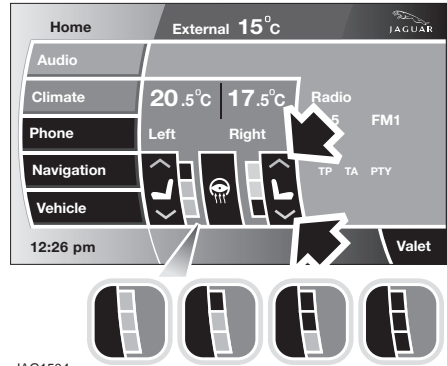

JAG1504

Note: To prevent the battery from becoming discharged, the climate seats will only operate when the engine is running.

Seat ventilation is adjusted through the vehicle touch-screen (from either the **Climate** or the **Home** menu). The climate seats have three heated and three cooled settings, indicated by the three bars adjacent to each seat icon. These bars will appear red when heated ventilation is selected, or blue when cooled ventilation is selected.

Heated ventilation

Touch the **up** arrow to activate heated ventilation for the chosen seating position. The system automatically selects the maximum heated ventilation setting (3 red bars illuminated).

To adjust the level of heated ventilation, touch the **down** arrow the appropriate number of times:

- 1 touch = intermediate heated ventilation (2 red bars).
- 2 touches = minimum heated ventilation (1 red bar).
- 3 touches = heated ventilation off (no bars illuminated).

Cooled ventilation

Touch the **down** arrow to activate cooled ventilation for the chosen seating position. The system automatically selects the maximum cooled ventilation setting (3 blue bars illuminated).

To adjust the level of cooled ventilation, touch the **up** arrow the appropriate number of times:

- 1 touch = intermediate cooled ventilation (2 blue bars).
- 2 touches = minimum cooled ventilation (1 blue bar).
- 3 touches = cooled ventilation off (no bars illuminated).

Backrest ventilation only

It is possible to set the seat ventilation so that only the seat backrest is ventilated. Backrest only ventilation is selected using the touch-screen.

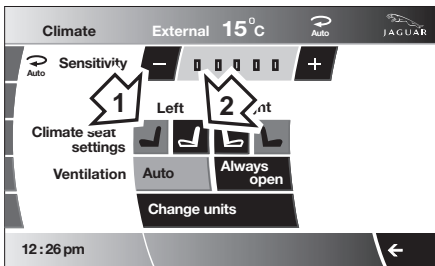

- From the Climate menu, select **Settings**.
- For the left or right front seat select the appropriate icon; either full seat ventilation (1) or seat backrest ventilation only (2).

Seat belts

GENERAL INFORMATION

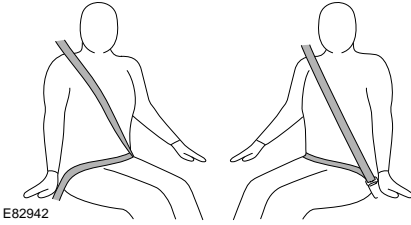

WARNINGS



Seat belts are life saving equipment. In a collision, occupants not wearing a seat belt can be thrown around inside, or possibly thrown out of the vehicle. This is likely to result in more serious injuries than would have been the case had a seat belt been properly worn. It may even result in loss of life.



The seat belts fitted to your vehicle are designed for adults and larger children. For their safety, it is very important that all infants and children under 12 years of age are restrained in a suitable child safety seat appropriate to their age and size. See **CHILD SEATS** (page 52).



Make sure all occupants are securely strapped in at all times - even for the shortest journeys.



Do not adjust the seat belt while driving.



Belts should not be worn with the straps twisted.



Each belt assembly must only be used by one occupant; it is dangerous to put a belt around a child being carried on the occupant's lap.

WARNINGS



Seat belts are designed to bear upon the bony structure of the body, and should be worn low across the front of the pelvis or the pelvis, chest and shoulders, as applicable; wearing the lap section of the belt across the abdominal area must be avoided.



Seat belts should be adjusted as firmly as possible, consistent with comfort, to provide the protection for which they have been designed. A slack belt will greatly reduce the protection afforded to the wearer.



Care should be taken to avoid contamination of the webbing with polishes, oils and chemicals, and particularly battery acid. Cleaning may safely be carried out using mild soap and water.



The belt should be replaced if webbing becomes frayed, contaminated or damaged.



It is essential to replace the entire assembly after it has been worn in a severe impact even if damage to the assembly is not obvious.



No modifications or additions should be made by the user which will either prevent the seat belt adjusting devices from operating to remove slack, or prevent the seat belt assembly from being adjusted to remove slack.



Replacement and renewal of seat belts should be carried out by Jaguar Dealers/Authorised Repairers only.



Do not carry hard, fragile, or sharp items between your person and the seat belt. In an impact the pressure from the seat belt on such items can cause them to break, which in turn may cause death or serious injuries.

Seat belts

WARNINGS



When using seat belts to restrain items other than occupants, take care to make sure that the seat belts are not damaged, or exposed to sharp edges.

The use of comfort clips or devices that would create slackness in the seat belt system is not advised.

Ensure that the webbing is midway between the neck and the edge of the shoulder. Correct tension is controlled by automatic retraction of the reel.

Always wear seat belts without slack or twists, since any slack in a seat belt reduces the effectiveness of the belt and the level of protection it can provide. For optimum protection, the seat belts should fit tightly around the body. Do not recline the front seats excessively. Optimum benefit is obtained from the seat belt with the seat back angle set to no more than 30 degrees from the upright.

Note: *If the vehicle is parked on unlevel ground, the seat belt mechanism may lock. This is not a fault, allow the seat belt to retract a small amount before gently easing the belt from its attachment to unlock it.*

Front occupants only: The front seat belts are equipped with an automatic webbing tension relieving device. This device will reduce the webbing loads experienced by the occupant when the seat belt is correctly worn without inducing any slack webbing.

The device is activated when, with the ignition system on and the seat belt tongue engaged in the buckle, webbing is extracted on occupant lean forward (a series of clicks indicate the range of movement with reduced tension).

If the engine is turned off with the seat belts still fastened, a slight increase in seat belt tension may be felt. This is normal, it is part of the seat belt assembly's tension control device.

Seat belt guide and retainer

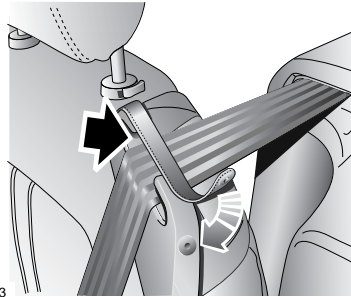

E90773

To assist with both access and positioning of the front seat belt webbing, a guide-retainer is incorporated into each front seat.

When access to the rear of the vehicle is required, remove the seat belt from the guide.

When returning the front seat to the previous upright position ensure that the seat belt is returned to the seat belt guide.

Seat belts

FASTENING THE SEAT BELTS

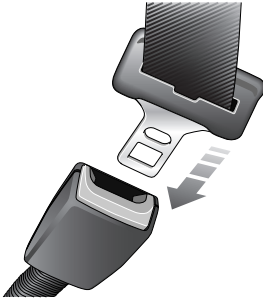

E82905

1. Draw the belt out smoothly, making sure that the seat and your position on the seat are correct. The belt should lay flat across the pelvis, chest, and mid-point of the collar bone between the neck and shoulder.
2. With the seat belt correctly positioned, place the metal tongue into the buckle nearest to you. Press it in until a click is heard.

Releasing the seat belts

To release the seat belt, press the red button.

Note: When releasing the seat belt it is advisable to hold the belt before pressing the release button. This will prevent the belt from retracting too quickly.

SEAT BELT REMINDER

The belt reminder feature provides additional reminders to the driver that an occupant's seat belt is unbuckled. A chime will sound intermittently.

Note: Not all countries have the warning chime.

Seat belt warning indicator



A warning indicator on the instrument panel is illuminated when:

- The driver's seat belt is not fastened.
- A passenger is sitting in the front seat and their seat belt is not fastened.

In some countries a warning signal sounds for six seconds.

INERTIA REEL MECHANISM TEST

- With the seat belt fastened, give the webbing near the buckle a quick upward pull. The buckle must remain securely locked.
- With the seat belt unfastened, unreel the webbing to the limit of its travel. Check that the unreeling is free from snatches and snags and then allow the belt to FULLY retract.
- Partially unreel the webbing, then hold the tongue plate and give it a quick forward pull. The mechanism must lock automatically and prevent any further unreeling.

If a seat belt should fail any of these tests, you should contact your Jaguar Dealer/Authorised Repairer immediately.

Seat belts

AUTOMATIC LOCKING RETRACTORS

WARNINGS



Where possible, use the seat belt automatic locking mechanism to secure items which are to be carried on the rear seats. In the event of a sudden manoeuvre, braking or an accident, loose items can cause serious injury.



Use the seat belt locking mechanism to secure pets in harnesses or pet carriers, when carried on the rear seats.

CAUTION



Care must be taken to prevent any sharp edges on items from damaging the belt.

1. Pull the seat belt around the item, using both the lap and shoulder parts of the belt to retain the object.
2. Fasten the seat belt.
3. Unreel all of the remaining belt, until the stop is reached, to engage the automatic locking feature.
4. Allow the seat belt to retract onto the item (a clicking sound will confirm that the mechanism has engaged).
5. Ensure that there is no slack in the seat belt, by pulling upwards on the shoulder belt, immediately above the item. The item will now be held firmly in position by the belt as the mechanism prevents any unreeling of the belt.

When the seat belt is released and is allowed to fully retract, the seat belt locking mechanism reverts to normal operation.

USING SEAT BELTS DURING PREGNANCY

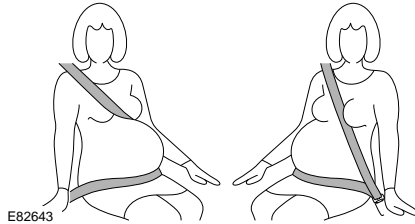

WARNINGS



Position the seat belt correctly for the safety of the mother and unborn child. Never wear just the lap strap, and never sit on the lap strap whilst using just the shoulder strap. Both of these actions are extremely dangerous, and may increase your risk of serious injury in the event of an accident or during emergency braking.



Never place anything between you and the seat belt in an attempt to cushion the impact in the event of an accident. It can be dangerous, and will reduce the effectiveness of the seat belt in preventing injury.

Position the lap strap comfortably across the hips beneath the abdomen. Place the diagonal part of the seat belt between the breasts and to the side of the abdomen. Make sure that the seat belt is not slack or twisted.

Supplementary restraints system

PRINCIPLE OF OPERATION

Introduction

WARNINGS



High speed impacts may cause serious injury or death irrespective of safety features fitted to the vehicle.

Always drive with caution and consideration for the vehicle's characteristics, road and weather conditions and do not exceed any speed limits in force.



Airbags inflate at high speeds and can cause injuries. To minimise the risk of injury, ensure that all vehicle occupants wear correctly positioned seat belts, sit correctly in the seats and position the seats as far back as is practical.



Airbag inflation takes place instantaneously, and cannot protect against the effects of secondary impacts. Under these circumstances the only protection will be provided by a correctly worn seat belt.

In the event of a collision, the airbag control unit monitors the rate of deceleration caused by the collision. This information is then used to determine whether airbags should be deployed.

Airbag deployment is dependent on the rate at which the passenger compartment changes velocity following the collision. The circumstances affecting different collisions (vehicle speed, angle of impact, type and size of object hit, etc.) vary considerably and will affect the rate of deceleration accordingly.

Advanced Restraint Technology System (ARTS)

WARNINGS



Seat belts should be worn at all times, by the driver and passengers in all seating positions. The Advanced Restraint Technology System (ARTS) cannot provide protection in some types of impact. Under these circumstances the only protection will be provided by a correctly worn seat belt.



Phone systems should only be installed by qualified persons familiar with the operation of, and requirements for, vehicles fitted with ARTS. If you are in doubt, seek advice from your Jaguar Dealer/Authorised repairer.

The airbags and seat belt pretensioners are electrically controlled by an Advanced Restraints Technology System (ARTS).

Various sensors determine the direction and severity of an impact. The system analyses this information then deploys only the appropriate airbags (e.g. the side airbags where the impact is on that side only).

Supplementary restraints system

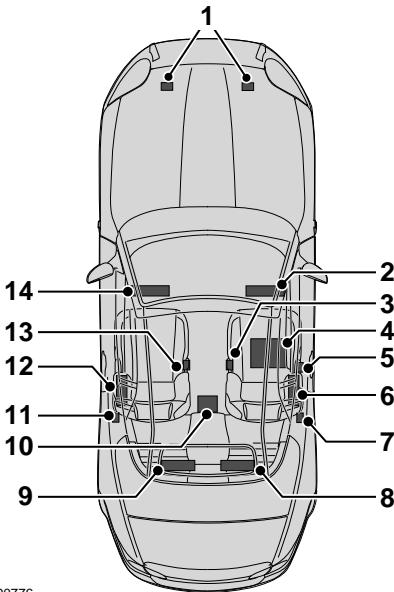

E90776

The ARTS components include:-

1. Dual front crash sensors.
2. Passenger dual stage airbag.
3. Passenger buckle pretensioner.
4. Passenger seat occupancy sensor.
5. Passenger belt tension sensor.
6. Passenger side head and thorax airbag.
7. Passenger side crash sensor.
8. Right-hand rollover protection bar (convertible only).
9. Left-hand rollover protection bar (convertible only).
10. Restraint control module.
11. Driver side crash sensor.
12. Driver side head and thorax airbag.
13. Driver buckle pretensioner.
14. Driver dual stage airbag (Steering wheel).

Note: The ARTS is not designed to operate as a result of:

- Rear impacts.
- Minor front impacts.
- Minor side impacts.
- Heavy braking.
- Driving at very low speeds and over bumps and pot holes.

Therefore, it follows that considerable superficial damage to the vehicle can occur without causing the airbags to deploy.

Supplementary restraints system

Airbag location

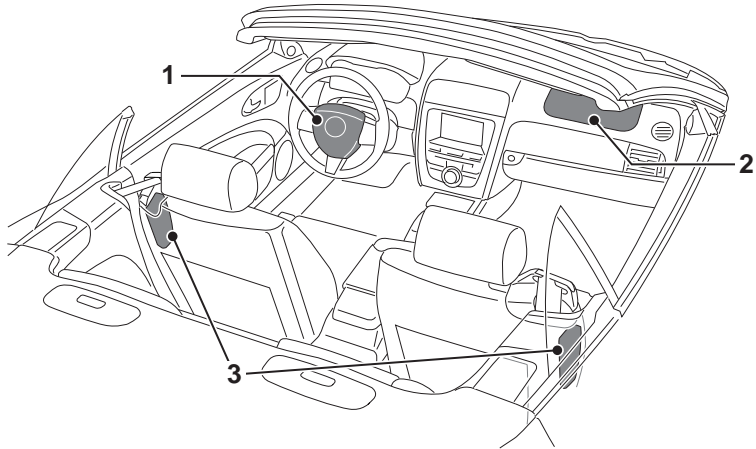

JAG1353

1. Driver's airbag.
2. Front passenger airbag.
3. Combined head and thorax side airbags.

OCCUPANT SENSING

WARNINGS



No objects whatsoever should be attached to the centre cover of the steering wheel, the passenger fascia panel, the sides of the front seats or the interior trim. Placing objects on or over the airbag inflation area may cause those objects to be propelled inside the vehicle causing serious injury to the occupants.



Occupants with disabilities who may require the vehicle to be modified should contact a Jaguar Dealer/ Authorised Repairer before any modifications are made.



Several airbag system components get hot after inflation. Do not touch them after they have deployed.

WARNINGS



If an airbag has inflated, it will not function again and must be renewed immediately. Until a new airbag is fitted, no protection is available in that position.

In order to provide optimum protection this vehicle is equipped with front and side airbags. They are used in conjunction with the seat belts to help protect occupants from upper body (thorax) and head injuries.

Supplementary restraints system

Occupancy classification sensor

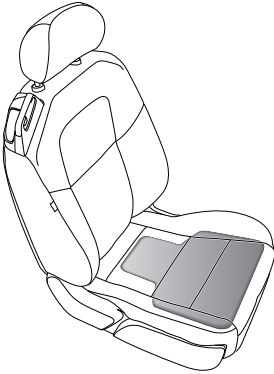

E90781

A weight sensor is located in the front passenger seat to determine the weight acting upon the seat.

In certain conditions, e.g. where no passenger is present, the appropriate airbags will be deactivated and the airbag deactivation indicator will illuminate. In a collision, these airbags would not be deployed.

The occupancy weight sensor operates as follows:

Passenger occupancy status	Passenger airbag status	Indicator active
Completely empty	Deactivated	No*
Low weight occupant or object	Deactivated	Yes**
Heavy occupant or object	Activated	No

* It is possible to receive an intermittent indicator illumination with an empty seat condition.

This is part of the system's adaptive behaviour, and does not affect the status of the passenger airbag. However, if the indicator becomes permanently illuminated when the seat is definitely empty and the seat belt is unbuckled, then contact your nearest Jaguar Dealer/ Authorised Repairer immediately.

** In some cases, a small child placed in a child seat will not activate the airbag deactivation indicator (PASS AIR BAG OFF). If this occurs, the passenger airbag status will be as described previously for an empty seat, i.e. passenger airbag not active, but the airbag deactivation indicator will not illuminate.

- If the seat is empty and the seat belt unbuckled, the front passenger airbag will not be activated and the airbag indicator will not be illuminated.
- If the seat is occupied by, for example, a small child or object with the seat belt buckled, the front passenger airbag will not be activated and the indicator will be illuminated.
- If the seat is occupied by a larger child or adult, the front passenger airbag will be activated and the airbag indicator will not be illuminated.

Note: The occupancy sensing system is designed to confirm that a front passenger is properly seated as recommended:

- Always sit centrally in the seat, remaining in contact with the seat back which, for comfort, should be rearwards of the vertical position.
- Adjust the seat to be as far back from the fascia as is practical. See **ELECTRIC SEATS** (page 34).
- Always wear seat belts.

Supplementary restraints system

Airbag deactivation indicator



JAG1354

The airbag indicator, on the centre console, is associated with the deployment conditions for front seat passenger airbags only.

Whenever the airbag indicator is illuminated, the front passenger airbag will not be deployed in the event of an impact. Where the airbags are not deployed, protection is provided by the seat belts.

Note: *The airbag indicator will illuminate when the ignition system initially comes on as part of the warning lamp check and will extinguish after approximately six seconds.*

DRIVER AIRBAG

WARNING



The airbag is a supplementary restraint system that provides additional protection in a severe impact only - it does not replace the need to wear seat belts. For maximum safety protection in all crash situations, a seat belt must be worn.

Note: *Provided front seat occupants are correctly seated, with seat belts worn, the airbag will give additional protection to the chest and facial areas in the event of an accident.*

Both front airbags use a dual inflation technology which means, if activated, the airbags will deploy as appropriate for the severity of frontal impact.

Airbag deployment

WARNINGS



Activation of an airbag creates dust, causing possible breathing difficulties for asthma sufferers or other people with respiratory problems. If an airbag is activated, any occupant who suffers from breathing difficulties should; either leave the vehicle as quickly as possible, or obtain fresh air by fully opening the windows and doors.



Following inflation, some airbag components are hot - do not touch until they have cooled.



Even with airbag equipment fitted, seat belts must always be worn because an airbag will only provide additional protection in certain types of frontal collision. No protection is afforded against the effects of rear impacts, or minor frontal impacts.



Inflation and deflation takes place instantaneously and will not provide protection against the effects of secondary impacts that can occur during multiple vehicle collisions.



An inflating airbag can cause facial abrasions and other injuries. Minimise the risk of injury by ensuring that front seat occupants are wearing their seat belts and are seated correctly, with the seat as far back as is practical.

Supplementary restraints system

When an airbag inflates, a fine powder is released. This is not an indication of a malfunction. However, the powder may cause irritation to the skin and should be thoroughly flushed from the eyes and any cuts or abrasions of the skin. After inflation, front and side airbags deflate immediately (head airbags deflate slowly). This provides a gradual cushioning effect for the occupants and also ensures that the driver's forward vision is not obscured.

Front protection

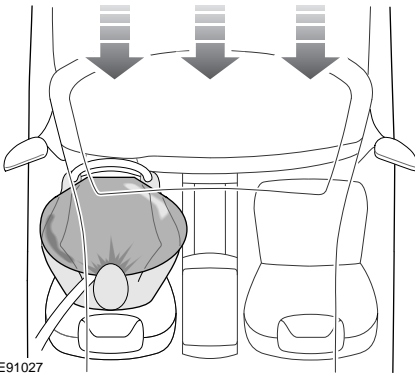

E91027

With a front impact of sufficient force, the restraints system will trigger the front airbag(s) and seat belt pretensioners, which immediately tighten the seat belts.

The seat belts then ease, allowing the head and chest to contact the inflated airbag. The airbag absorbs the remaining energy of the impact and then deflates rapidly via vent holes.

Front airbags are designed to inflate only in frontal and near frontal collisions.

PASSENGER AIRBAG

WARNINGS



To minimise the risk of injury if the airbag deploys, the front passenger must sit as upright as possible with feet on the floor and back against the seat backrest. The seat belt must be secured.



Do not put objects in front of or above the dashboard where the passenger airbag is located.

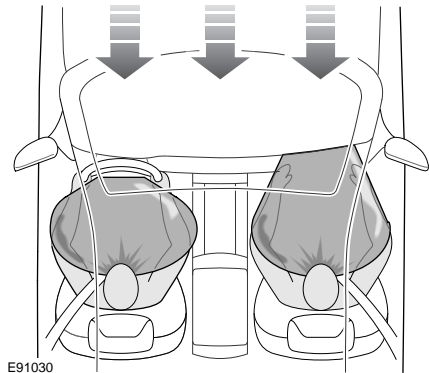

E91030

The passenger airbag is fitted and stowed above the glove compartment. This panel is marked **AIRBAG**. See **OCCUPANT SENSING** (page 45).

Supplementary restraints system

SIDE AIRBAGS

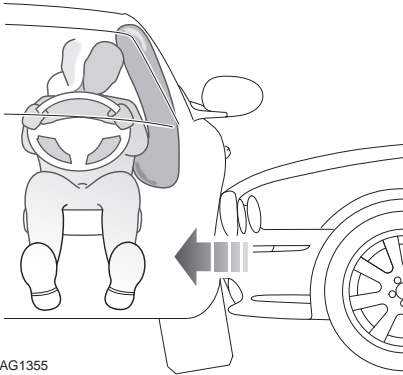

JAG1355

WARNING



To ensure that the side airbags are fully effective do not sit too close to, or lean against the door trim. The side airbag could injure you as it deploys from the side of the seat.

The airbags, in combination with the seat belts, can help reduce the risk of severe injuries in the event of a significant side impact collision.

When the seat mounted head and thorax airbag inflates, it breaks through the seat bolster stitching, giving protection to the side of the rib cage and head of the driver or front seat passenger.

The combined head and thorax side airbags are designed to inflate only in a side impact collision, unless the collision causes sufficient lateral deceleration.

AIRBAG WARNING LAMP



The airbag warning indicator in the driver's instrument panel will be lit for approximately six seconds when the ignition is turned on.

If the indicator remains on, it indicates a fault. You should report the fault to a Jaguar Dealer/Authorised Repairer immediately. It is safe to drive the vehicle; however, in an accident the airbags may not operate. See **WARNING LAMPS AND INDICATORS** (page 92).

WHIPLASH PROTECTION

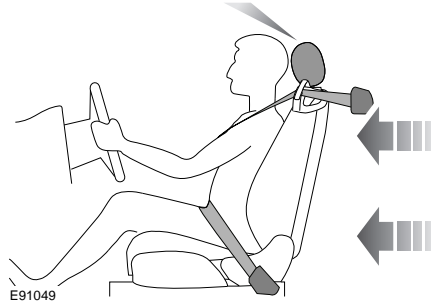
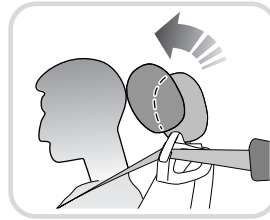

E91049

Both front seats are equipped with Active Head Restraints (AHR) which reduce the risk of neck and spinal injury (whiplash) in the event of a rear impact. When activated, the head restraint moves upwards and forwards, supporting the occupant's head.

After activation, the whiplash protection mechanism automatically resets and does not need to be replaced.

Supplementary restraints system

ROLLOVER BARS

WARNINGS



Do not place any objects on top of the system trim covers behind the rear passenger head restraints as they could prevent correct deployment of the system.



Do not try to reset the system if it deploys.



Do not let anyone sit on the top cover.

The Rollover Protection Device (RPD) consists of two inverted U-shaped bars, that are concealed underneath the rear parcel shelf, and sensors that monitor the attitude of the vehicle.

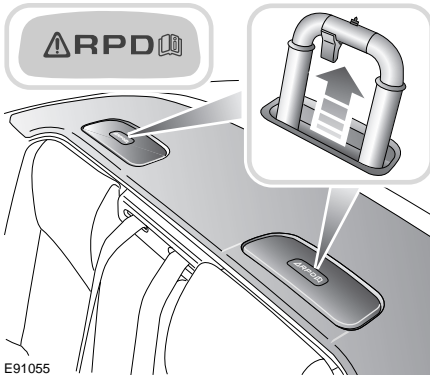

E91055

If the sensors determine that a risk of rollover is imminent, the RPD will be deployed.

Note: *If the convertible roof is closed when the RPD is deployed, the bars are designed to break through the rear screen.*

If the RPD has been deployed, you should proceed to your nearest Jaguar Dealer/ Authorised Repairer to have the vehicle checked for any damage and to have the system reset.

AIRBAG LABELS

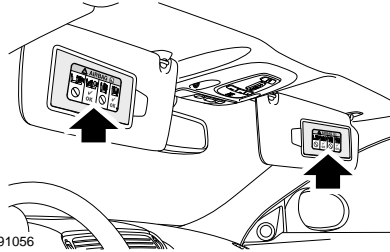

E91056

Airbag warning information is printed on the driver's and passenger's sun visor.

Supplementary restraints system

AIRBAG SERVICE INFORMATION

WARNINGS



Do not attempt to service, repair, replace, modify, or tamper with, any part of the Advanced Restraints

Technology System (ARTS). This includes wiring or components in the vicinity of ARTS components. Doing so may cause the system to trigger, or render the system inoperative, either of which may result in death or serious injuries.



Do not use any electrical test equipment, or devices in the vicinity of ARTS components or wiring. Doing so may cause the system to trigger, or render the system inoperative, either of which may result in death or serious injuries.

All of the following operations should only be carried out by a Jaguar Dealer/Authorised Repairer, or suitably qualified person:-

- Removal or repair of any wiring or component in the vicinity of any ARTS components.
- Installation of electrical, or electronic, equipment and accessories.
- Modification to the front or sides of the vehicle exterior.
- Attachment of accessories to the front or sides of the vehicle.

In the event of the vehicle being dismantled, airbag module removal and disposal must be carried out by a qualified person.

Child safety

CHILD SEATS

General safety information

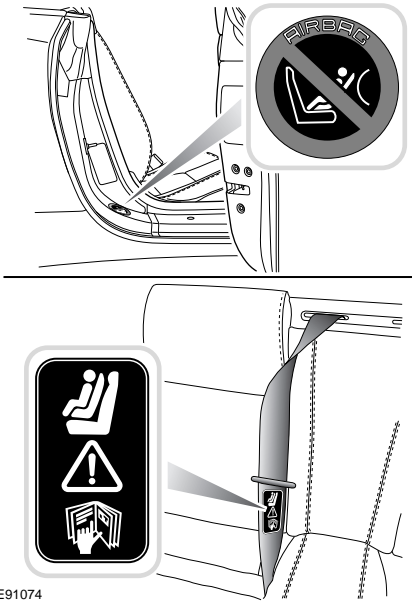

WARNINGS



Do not install a rearward-facing child seat in the front passenger seat position since deployment of the passenger facia airbag could cause death or serious injury to the child. If, however, you have no alternative but to place a child in the front passenger seat, use only a forward-facing child seat with the passenger seat set fully rearward and in its lowest position.

In many countries legislation governs how and where children should be carried when travelling in a vehicle.

It is the responsibility of the driver to comply with all regulations in force in the country where the vehicle is being used.

Holding a baby or child in a person's arms is not a substitute for a child restraint system.

In an accident, a baby or child held in this manner can be crushed between the vehicle's interior and a restrained person.

The child can be injured by hitting the interior or by being thrown from the vehicle during a sudden manoeuvre or impact.

The seat belts fitted to your vehicle are designed for adults and larger children. For their safety, it is very important that all infants and children under 12 years of age are restrained in a suitable child safety seat appropriate to their age and size. See **CHILD SEAT POSITIONING** (page 54).

WARNINGS



Extreme hazard! Do not use a rearward facing child restraint on a seat protected by an airbag in front of it!



Children must be restrained by a child safety restraint that is suitable for their weight and size.



The rear seat is the safest place for properly restrained children.

Child safety

Choosing a suitable child seat

WARNING



Choose a child seat that sits securely on the seat cushion and against the seat back.

Before you buy a child seat, it is important to note that your child's weight, rather than age, determines the type of seat that is required.

Jaguar strongly recommends the use of ISOFIX seats. See **ISOFIX ANCHOR POINTS** (page 57).

Babies and small children who cannot sit up by themselves should be carried in an approved rear facing infant carrier, which should always be installed in a rear seat position.

Jaguar recommends that a rear-facing seat with a harness is used for as long as your infant's development allows.

Note: For approved child restraints, you should contact your Jaguar Dealer/Authorised Repairer.

Do not use a forward-facing seat until your child is above the minimum weight of 9 kg (20 lb.) and able to sit up unaided. Up to the age of two, a child's spine and neck are not sufficiently developed to avoid injury in a frontal impact.

We strongly advise that you do not buy or use a second-hand child seat. The seat may have been used inappropriately, or involved in an accident. In such circumstances, the seat may not protect your child.

Always check that the child seat can be mounted securely in the required position: if in doubt, you should speak to your Jaguar Dealer/Authorised Repairer.

Look for the following when selecting a child restraint system:

- It should have a label certifying that it meets the applicable regulations.
- Carefully read the instructions supplied with the restraint. Be sure you understand them and can install and use the device properly and safely in the vehicle.
- Ensure that the child restraint system is appropriate for the child's weight and development. See **CHILD SEAT POSITIONING** (page 54).

Child safety

CHILD SEAT POSITIONING

Suitability of each passenger seat position for the carriage of children up to 12 years of age or 1.35m (approx. 4.4 ft.) tall and the installation of child restraint systems.

Mass group (with approximate age) as indicated on child restraint	Vehicle seating position	
	Front passenger	Rear
0 = Up to 10 kg (22 lb.) (birth to 9 months)	X	U**
0+ = Up to 13 kg (28 lb.) (birth to 18 months)	X	U**
I = 9 to 18 kg (20 - 40 lb.) (9 months to 4 years)	UF*	U
II = 15 to 25 kg (33 to 55 lb.) (4 to 9 years)	U*	U
III = 22 to 36 kg (48 to 80 lb.) (8 to 12 years)	U*	U

- **U** = Suitable for Universal category restraints approved for use in this mass group.
- **UF** = Suitable for forward-facing Universal category restraints approved for use in this mass group.
- **X** = Seat position not suitable for child restraint in this mass group.

Note: * When installing a child restraint in the front passenger seat, the front passenger seat should be positioned fully rearward with the cushion height adjustment set to front fully down and rear fully up. Also the backrest must be set as far forward as possible.

Note: ** Rear passenger space is restricted. The front seat must be moved forward and upwards to install any rearward facing infant carrier. Care must be taken not to load any part of the child seat or carrier when repositioning the front seat. The space available for front seat occupants will be reduced by the fitment of any rearward facing infant carrier.

Note: If there is any doubt about which age/weight category the child conforms to, then always use a child seat or carrier appropriate to the weight of the child.

Automatic locking reel (ALR)

The rear passenger seat belts have an automatic locking device for use with child seats. When engaged, this device allows the belt to be retracted (tightened) but not extended. When used to secure a child seat, therefore, the belt will automatically lock at any point to which it has retracted.

1. Pull the seat belt all the way out to engage the locking device.
2. Insert the metal tongue plate into the buckle. A positive click indicates that it is safely locked.
3. To fix the seat firmly, retract the belt back to the reel, a ratchet operation may be felt as the belt retracts. Continue to feed the belt back onto the reel until it fits snugly around the child seat.
4. Push down on the child seat to ensure any slack is taken in by the mechanism.

The above is a guide only. Depending on the features of a particular child seat, e.g. forward or rearward-facing, engage the locking device before or after attaching the belt, as convenient.

Unbuckling the belt and releasing the child seat will allow the belt to resume its normal operation.

Child safety

General check list

Follow the check list each time your child travels in the vehicle:

- Carefully follow the instructions provided by the manufacturer of the restraint system.
- Make sure your child falls into the correct weight range for the seat.
- Always use the appropriate child restraints and adjust harnesses for every child, every trip.
- Avoid dressing your child in bulky clothing and do not place any objects between the child and the restraint system.
- Regularly check the fit of your child seat and replace seats or harnesses that show signs of wear.
- No child seat is completely child-proof. Encourage your child not to play with the buckle or harness.
- Never leave a child unsupervised in the vehicle.
- Ensure your child does not exit the vehicle from the side where there is traffic.
- Set your child a good example - always wear your seat belt.
- Ensure that you have removed all slack from the adult seat belt.

CHILD RESTRAINT TOP TETHER ANCHORAGES

(Australia only)

WARNING



Child restraint anchorages are designed to withstand only those loads imposed by correctly fitted child restraints. Under no circumstances are they to be used for adult seat belts, harnesses or for attaching other items or equipment to the vehicle.

Coupe

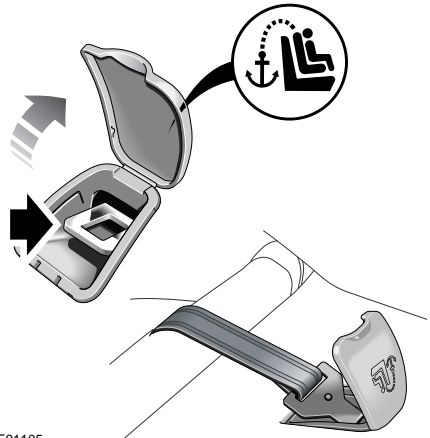

E91105

The top tether anchorages are positioned on the rear parcel shelf, under access covers, at the centre-line of each rear seating position.

Lift the cover and connect the top tether to the anchorage on the rear shelf. Adjust the length of the top tether strap to hold the top of the child seat against the vehicle seat back.

Ensure the child seat is securely fitted.

Child safety

Convertible

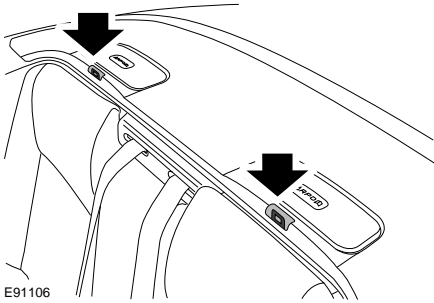

Two child restraint anchorages are provided. These are located under top tether covers in the rear tonneau.

Refer to the child restraint manufacturer's fitting and operating instructions prior to installation. Other child restraint devices may not offer the same level of protection and it is recommended that only the supplied device is used in the convertible.

To expose a top tether:

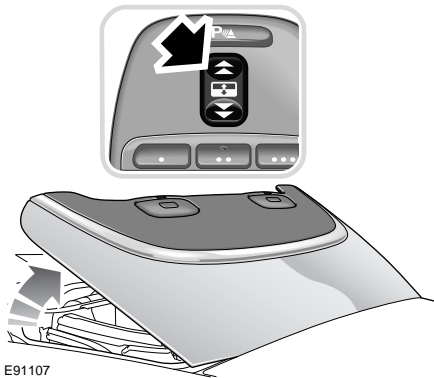

1. Open the tonneau panel by briefly pressing and holding the front of the convertible top overhead console switch.

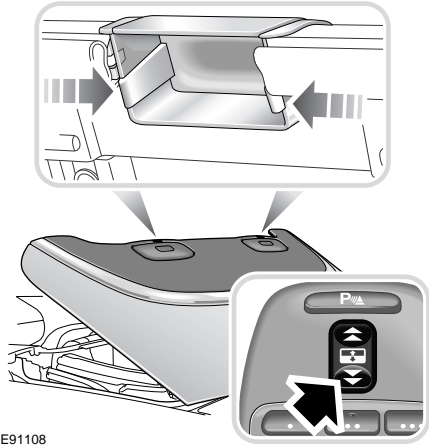

2. Remove the top tether cover and close the tonneau panel by briefly pressing and holding the rear of the convertible overhead console switch.
3. Ensure that the tonneau top tether cover is safely stowed in the glove compartment.

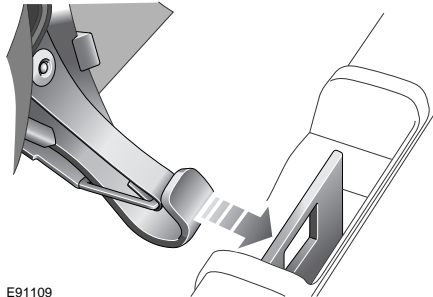

4. Attach the child restraint top tether clip to the top tether anchorage bracket.

If an additional child restraint device is required, please enquire through your Authorised Jaguar Retailer.

Child safety

BOOSTER CUSHIONS

In a situation where a child is too large to fit into a child safety seat, but is still too small to safely fit the three point belt properly, a booster seat is recommended for maximum safety. Follow the manufacturer's instructions for fitting and use, then adjust the seat belt to rest on the child's shoulder, not the neck.

ISOFIX ANCHOR POINTS

(not Australia)

WARNINGS



If the restraint is not correctly anchored, there is a significant risk of injury to the child in the event of a collision or emergency braking.



Child restraint anchorages are designed to withstand only those loads imposed by correctly fitted child restraints. Under no circumstances are they to be used for adult seat belts, harnesses or for attaching other equipment or items to the vehicle.



If removing a head restraint in order to fit a child restraint, always secure the head restraint when storing it. If left loose in the vehicle it may cause death or serious injury during sudden braking or an impact.

The rear seats of your vehicle are fitted with anchor bars that comply with International Standard Organisation regulations (ISO). They allow the ISOFIX child seats to be secured directly and easily to the vehicle body without the use of adult seat belts.

The ISOFIX system reduces the likelihood of incorrect fitting and is also quicker and simpler to use.

When installing either a front or rear facing ISOFIX child seat in the rear seats, the seat directly in front of the rear seat being used, must be set in its most forward position and with the seat in its most upright position. Therefore, it is not recommended that the front seat is occupied while using an ISOFIX child seat.

Child safety

ISOFIX child seat positioning

Mass group*	Size classes	Fixtures	Vehicle ISOFIX positions
			Rear seats
Carrycot	F/G	ISO L1/L2	X
0 = Up to 10 kg (26.8 lb.)	E	ISO R1	IL*
0+ = Up to 13 kg (34.8 lb.)	E	ISO R1	IL*
0+ = Up to 13 kg (34.8 lb.)	C/D	ISO R2/R3	X
I = 9 kg to 18 kg (24 lb. to 48 lb.)	C/D	ISO R2	X
	A/B	ISO F2/F3	X
	B1	ISO F2X	IL*
II = 15 kg to 25 kg (40.2 lb. to 67 lb.)	-	Not Applicable	Not Applicable
III = 22 kg to 36 kg (59 lb. to 96.5 lb.)	-	Not Applicable	Not Applicable

- **IL** = Suitable for particular ISOFIX child restraint systems (CRS) given in the attached list*. These ISOFIX CRS are those of the specific vehicle, restricted, or semi-universal categories.
- **X** = ISOFIX positions not suitable for ISOFIX child restraint systems in this mass group and/or this size class.
- ***** = Child seats recommended for use in these locations are Britax or Roemer Duo Plus Isofix, Britax Cosy-tot Isofix or Roemer Baby-safe Isofix.

Note: ISOFIX anchorages are provided for rear seats only. ISOFIX child restraints should be securely attached, following the manufacturer's instructions, at these locations only.

Child safety

Installing an ISOFIX child seat

CAUTION



Always follow the manufacturer's instructions supplied with the ISOFIX child seat.

The anchorage loops are accessible through two trimmed apertures at the back of the rear seat cushion.

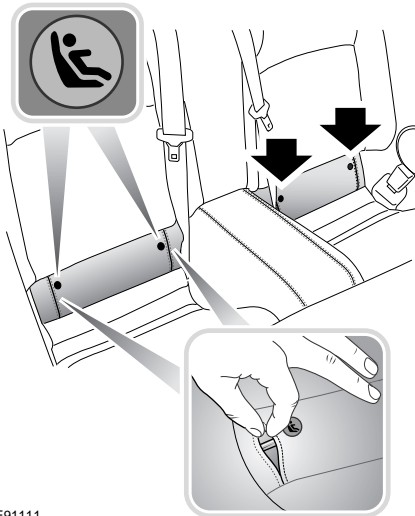

E91111

Their location is highlighted by the small tag labels with a child seat graphic. The anchorage loops are located approximately 60 mm (2.5 inches) below each label. Pull back the side of the trim to reveal the aperture and the anchorage loops.

Fit the seat as follows (the following is to be considered only as a guide):

1. Push the adult seat belt buckles into their stowage recesses, to ensure they do not interfere with the fitment of the child seat.

2. Make sure there is nothing obstructing the seat mounting mechanism at the anchorage points.
3. Fully extend the two attachment legs on the child seat. Ensure the hook at the end of each leg is open.

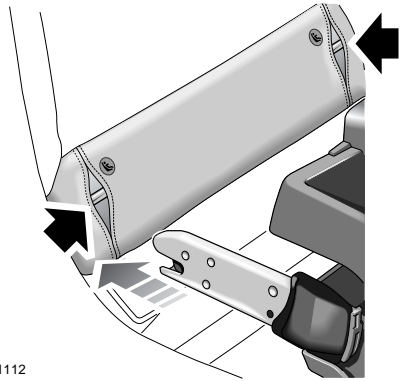

E91112

4. Position the attachment legs just in front of the trimmed apertures for the ISOFIX anchorage loops. Push the anchorage leg through the trimmed aperture to engage with the vehicle's anchorage loop. There should be an audible click.
5. Repeat Step 4 for the child seat's second anchorage leg.
6. Using firm and even pressure on both sides, push the child seat rearwards until it is secured firmly against the seat back. Make sure you do not trap the top tether strap behind the child seat.
7. If your vehicle is fitted with top tether anchorage brackets, make sure that the top tether strap is secured.
8. As a final check, firmly pull both sides of the seat to confirm that it is correctly locked into position.

Child safety

Removing the ISOFIX seat

To remove the ISOFIX child seat, press the locking button on each side of the seat to release anchorage legs. If your vehicle is fitted with top tether anchorages, undo the top tether strap and lift the child seat from the vehicle.

Pedestrian protection

PRINCIPLE OF OPERATION

The pedestrian protection system has been designed to reduce lower leg and head injuries in the event of a frontal collision with a pedestrian.

The bumper includes energy absorbing foam and plastics in its construction to reduce leg injuries and sensors that detect the collision with a pedestrian.

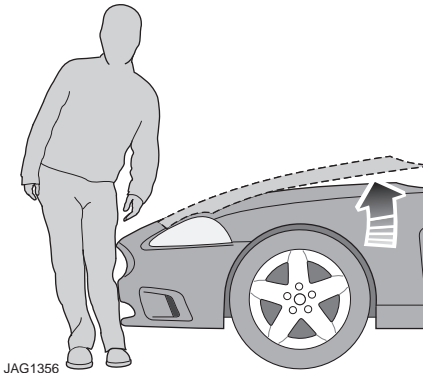

Deployment

During a pedestrian collision, the sensors initiate a bonnet deployment system that releases the bonnet latches and raises the rear edge of the bonnet by approximately 130 mm (5.1 inches).

This increases the gap between the bonnet and the components within the engine compartment e.g. engine, suspension etc. This increased gap creates a cushion which reduces injuries caused to the pedestrian.

The bonnet deployment system is active only when the ignition is on and the vehicle is driven between the speeds of approximately 15 km/h (9 mph) and 45 km/h (28 mph).

AFTER DEPLOYMENT OF THE PEDESTRIAN PROTECTION SYSTEM

The bonnet will remain in its unlatched position and cannot be relatched.

The vehicle must be stopped as soon as it is safe to do so.

The hazard warning lamps will be activated and can only be switched off by pressing the engine START/STOP button to turn the engine off and on again.

The warning message **CHECK PEDESTRIAN SYSTEM** will appear on the message centre and the vehicle should be transported to the nearest Jaguar Dealer/Authorised Repairer. The vehicle must not be driven when the bonnet has been deployed. See **DRIVING AFTER A COLLISION** (page 230).

Note: If the warning message **CHECK PEDESTRIAN SYSTEM** appears on the message centre when there has been no deployment of the bonnet, the vehicle can be driven and should be taken to the nearest Jaguar Dealer/Authorised Repairer immediately.

If any significant damage occurs to the front bumper it should be inspected by a Jaguar Dealer/Authorised Repairer as soon as possible.

Steering wheel

ADJUSTING THE STEERING WHEEL

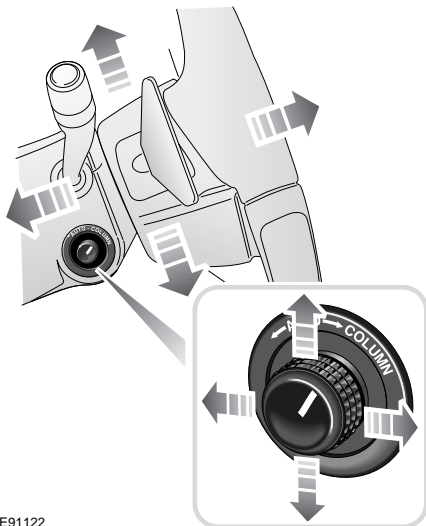

E91122

WARNING



Never adjust the steering wheel position whilst the vehicle is in motion. Doing so will reduce control of the vehicle, and may cause unpredictable steering movements.

CAUTION



Do not use steering wheel mounted security devices since movement of the steering wheel in entry or exit mode could result in damage to the vehicle (e.g. the windscreen) or possible injury to the occupant.

The steering wheel can be adjusted for tilt and reach.

1. Turn the switch to the **COLUMN** or **AUTO** position.
2. Move the switch forwards or backwards to adjust reach.
3. Move the switch up or down to adjust tilt.

Three steering wheel positions can be stored and recalled by the driver position memory system. See **MEMORY FUNCTION** (page 122).

The message centre will indicate which switch position has been selected, by displaying the message **COLUMN ADJUST** or **COLUMN ADJUST AUTO**.

Entry and exit mode

Entry and exit mode provides automatic movement of the steering column to allow easier entry to or exit from the vehicle.

Entry and exit mode is selected by setting the steering column adjustment switch to the **AUTO** position.

Exit: If the ignition system is in the convenience mode position and the driver's door is opened, the steering column will move to the uppermost tilt position, unless already in that position.

Entry: When the door is closed and the START/STOP button is pressed, the steering column will return to the previous position.

Notes on entry and exit mode operation

- If the steering column switch is moved away from **AUTO** whilst the steering column is tilted away, the steering column will move back to its previous position when the driver's door is closed and the START/STOP button is pressed.
- If the steering column is adjusted during entry and exit operation, steering column movement will stop.

Steering wheel

STEERING COLUMN LOCK

An electronic steering column lock is fitted to the steering column. It is unlocked automatically when a recognised Jaguar Smart Key is inside the vehicle.

The steering column is automatically locked when the engine and ignition systems are off, the gear selector is in **P** (Park) and the driver's door is opened.

CAUTION

⚠ During vehicle recovery the remote handset must remain inside the vehicle or be stowed in the starter control unit in the centre console, so that the steering remains unlocked.

Any malfunction of the steering column lock will be indicated by the message **STEERING COLUMN LOCKED** displayed by the message centre. If this occurs:

1. Press the engine START/STOP button to return to convenience mode.
2. Turn the steering wheel gently left and right, to unlock the steering column.
3. If the malfunction still persists, seek qualified assistance as soon as possible.

HORN

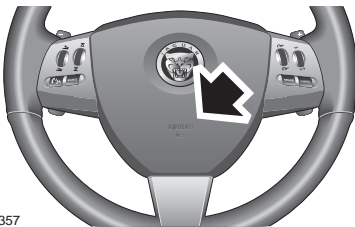

JAG1357

The dual tone horn is operated by pressing the centre pad on the steering wheel.

The horn also operates as a warning horn if the vehicle alarm system is activated.

HEATED STEERING WHEEL

The heated steering wheel is activated via the touch-screen from the Home menu.

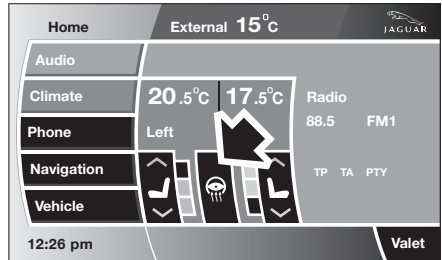

JAG1420

With the engine running, touch the steering wheel icon to turn the steering wheel heater on or off.

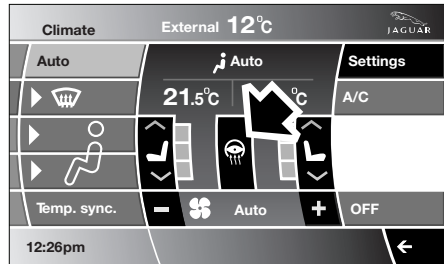

E94700

The heated steering wheel can also be activated in the same way via the Climate menu.

Steering wheel

AUDIO CONTROL

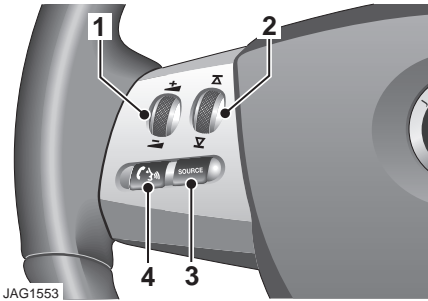

1. Increase or decrease volume.
2. Cycle through preset radio stations or next CD track. A short press will seek up or down to next preset station or next CD track. Press and hold for two seconds to select next strong radio station or next CD.
3. Cycle through radio FM, AM and CD changer. Press and hold for two seconds to select Phone Ready mode.
4. Select mute or answer phone call when ringing.

CRUISE CONTROL

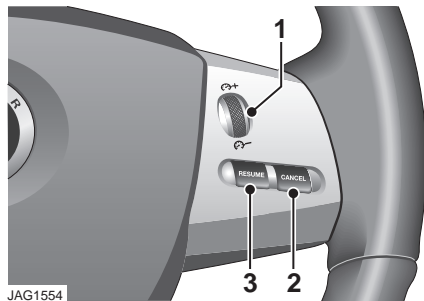

The cruise (speed) control system can be used by the driver to maintain a selected vehicle speed without the driver having to use the accelerator.

Controls on the steering wheel allow the driver manual control of the system.

1. **Speed adjustment control:** The thumb wheel is used to engage cruise control initially. It is also used to increase or decrease the set speed.
2. **CANCEL:** Cancels cruise control but retains the set speed in memory.
3. **RESUME:** Engages cruise control after it has been cancelled.

For further information:

See **USING CRUISE CONTROL** (page 148).

See **USING ACC** (page 150).

Lighting

LIGHTING CONTROL

Note: If the ignition system is off and the lamps are left on, the message centre will display **LIGHTS ON**.

The exterior lamps are controlled by the left-hand column stalk switch.

The rotary collar on the stalk has three positions for turning the exterior lamps on or off and positions for autolamps and exit delay. These are:

Off

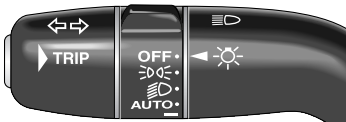

E91137

All exterior lamps off (except vehicles provided with daylight running lamps).

Side lamps

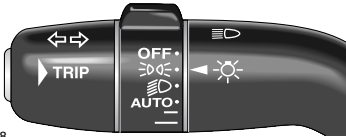

E91138

Switches on the side, tail and number plate lamps and marker lamps required by local legislation. The instruments will also be lit.

Headlamps

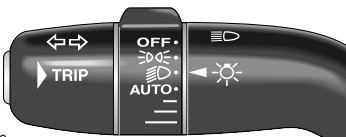

E91139

With the ignition in convenience mode, select this position to switch on the headlamps

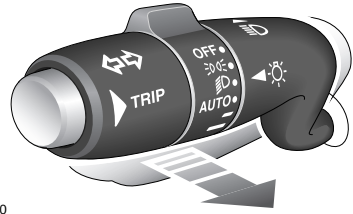

E91140

Headlamp flash: Pull the switch towards the steering wheel and release, to flash the high beam on and off. The high beam will remain on for as long as the switch is held.

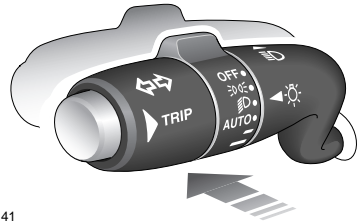

E91141

High beam: With the headlamps on, push the switch away from the steering wheel to switch to high beam.

The blue warning indicator on the instrument panel will illuminate.

To turn high beam off and return to low beam, pull the column switch towards the steering wheel.

Note: If the rotary control switch is turned to the OFF position, with high beam still activated, the headlamps will be extinguished. The headlamps will illuminate at high beam when the headlamps are turned on again.

Lighting

Autolamps

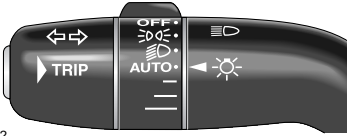

E91142

A light sensor, mounted on the front of the fascia, monitors exterior light levels and automatically switches the side lamps and low beam headlamps on or off.

The ignition system must be on for full automatic light operation.

When light fades towards dusk, the side lamps and headlamps will switch on automatically.

At dawn, as light increases, the side lamps and headlamps switch off automatically.

Do not cover the sensor and keep the windscreen clean. Obstructing the light in this area of the sensor may lead to unwanted operation of the side lamps and headlamps.

Windscreen wiper detection

This function only operates when autolamps is selected. The side lamps and headlamps will switch on automatically if the windscreen wipers are switched on for 20 seconds or more. Once the windscreen wipers are switched off, the side lamps and headlamps will automatically switch off two minutes later.

Autolamps with exit delay

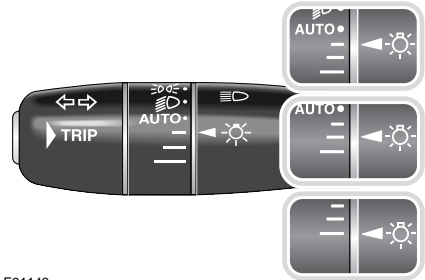

E91143

Three settings on the rotary collar set the time that the headlamps will remain on after the driver's door has closed:

- 30 seconds.
- 60 seconds.
- 120 seconds.

The message centre will display the change set delay **AUTOLAMP DELAY X:XX** or **AUTOLAMP DELAY OFF** when the autolamp delay function has been turned off.

Note: If the lamp switch rotary collar is in the **AUTO** position there will be no exit delay and the headlamps will turn off when the ignition system is off.

Lighting

Daylight running lamps

In certain countries it is a legal requirement for the lamps to be on during the hours of daylight.

With the rotary collar in the OFF position, low beam headlamps, side lamps, tail, number plate lamps and, where fitted, side marker lamps will switch on automatically with the following conditions:

- The ignition is on (Scandinavia only).
- The vehicle gear selector out of **P** (Park).
- The parking brake is not applied (is released).

Door guard and puddle lamps

Door guard lamps are fitted to each door to give warning of an open door to passing vehicles. Puddle lamps illuminate the step out area at night.

Each lamp comes on automatically when the door is opened. If the door is left open the lamps remain on for approximately 15 minutes after returning from convenience mode to power off.

Condensation

In certain circumstances, misting may occur on the inside of a lamp lens. This is caused by natural changes in environmental conditions.

This misting is not detrimental to lamp performance and will clear during normal usage.

REAR FOG LAMPS

CAUTION



Only use the fog lamps when visibility is severely restricted by fog.

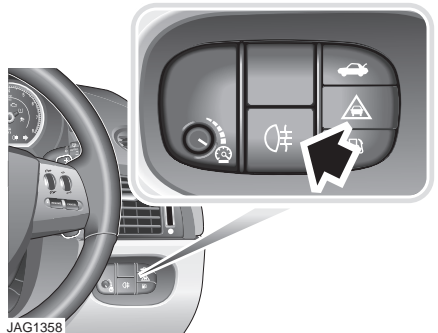
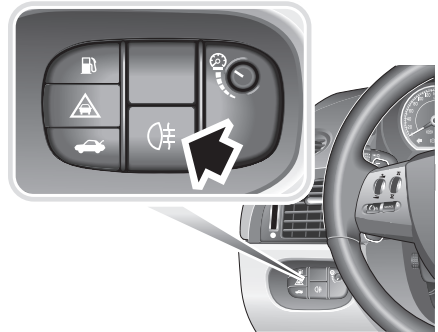

JAG1358

The rear fog lamps can only be switched on if the low beam headlamps are on.

Press the switch to turn on the rear fog lamps. Press the switch again to turn the lamps off.

Note: The fog lamps will be turned off when the ignition system is turned off, but will need to be reselected when the ignition system is turned on again.

Lighting

HEADLAMPS - DRIVING ABROAD

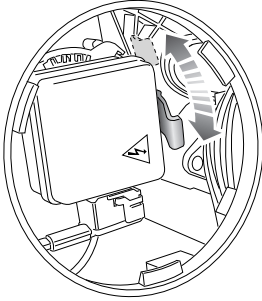

E91157

The tourist levers allow you to adjust the headlamps to the correct beam pattern for driving in left or right-hand drive territories.

When new, the levers will be set to the correct position for the country in which the vehicle is sold. To change the pattern for driving on the other side of the road, move the levers to the opposite position.

To adjust the headlamp beam pattern:

Note: When changing the beam pattern, ensure that you change the lever position on both headlamps.

1. Remove the headlamp unit. See **CHANGING A BULB** (page 73).
2. Twist the headlamp unit rear cover counterclockwise and lift off.
3. Locate the adjustment lever, as shown.
4. Move the lever to the opposite position.
5. Refit the headlamp rear cover and the headlamp unit. See **CHANGING A BULB** (page 73).

Remember to place the levers back in their original position when you have returned to your country of origin.

HEADLAMP LEVELLING

Headlamp levelling is adjusted automatically. Automatic levelling of the headlamps is a feature which avoids dazzling oncoming drivers. A control unit adjusts the aim of the lamps to account for acceleration, deceleration and vehicle load conditions.

HAZARD WARNING FLASHERS

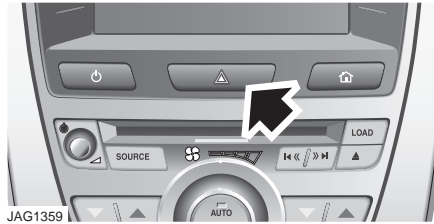

JAG1359

Press the switch to turn the hazard warning lamps on. When the hazard warning flashers are operating, the indicator warning lamps will flash in time with the hazard warning flashers.

Press again to turn the hazard warning flashers off.

Hazard warning flashers should only be used in an emergency, to warn traffic of a vehicle breakdown or approaching danger.

Note: Hazard warning flashers can be used when the ignition is on or off.

Lighting

ADAPTIVE FRONT LIGHTING SYSTEM (AFS)

The Adaptive Front Lighting System (AFS) is designed to give the driver improved visibility under varying driving conditions.

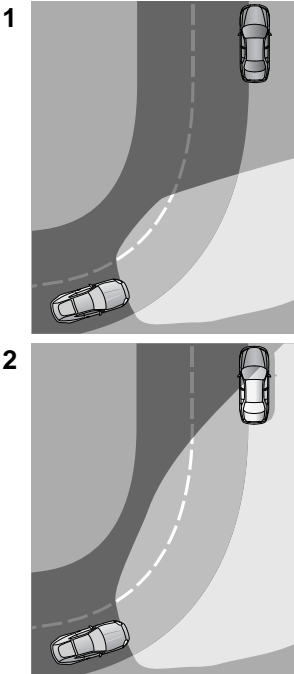

E91159

1. Light spread of a vehicle not fitted with AFS.
2. Light spread of a vehicle fitted with AFS.
The main light source consists of bi-functional (high and low beam) xenon projector units. The projector units are swivelled left or right to improve the light spread on bends in the road.

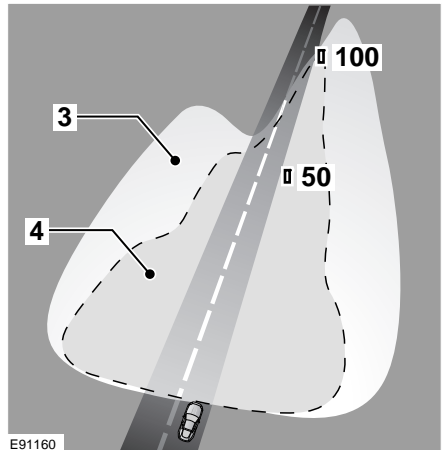

Bi-Xenon lamps (3) provide significantly improved visibility over halogen lamps (4). They also react dynamically in the vertical plane to the vehicle's braking or acceleration to maximise headlamp performance.

The units operate when the engine is running and the lighting control switch set to headlamps or AUTO, if the ambient light has fallen below a preset level.

The system takes inputs from the vehicle's road speed, steering angle to determine the amount of horizontal swivel. The amount of swivel is highest at low speed, manoeuvring speeds and reduces as speed increases.

If reverse gear is selected, the lamps return to the central position and the swivelling capability is disabled.

When the engine is started, the headlamps can be seen to swivel as they initiate a self-calibration cycle for a few seconds.

Lighting

Cornering or static bending lamps

Additional lighting comes from the cornering or static bending lamps which are angled outwards from the centre line of the vehicle.

These lamps broaden the beam of the headlamps when cornering during normal night driving.

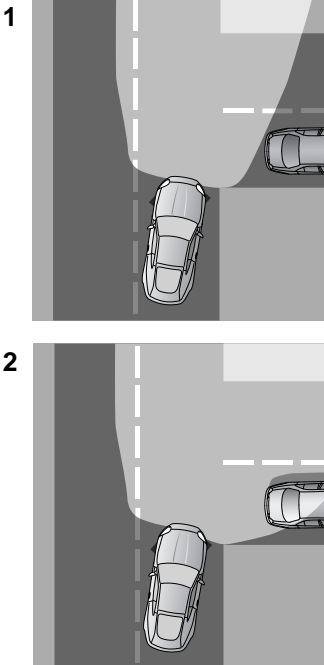

E91161

1. Light spread of a vehicle **not fitted** with static bending lamps.
2. Light spread of a vehicle **fitted** with static bending lamps.

The system switches on the lamp if it has received an input from the vehicle's direction indicators. Only the lamp on the same side as the operating direction indicator illuminates.

As the system is ignition based, the lamp will not stay on, even if the vehicle is parked (and the ignition switched off) with the direction indicator lever in the operating position.

Note: Excessive rotation of the steering wheel while the ignition system is off, may cause incorrect calibration of the static bending lamps. In extreme situations, the lamps may operate earlier than previously experienced. However, correct calibration of the lamps is automatically re-established within 30 seconds of the vehicle being driven.



If a system fault is detected the headlamps will attempt to move to the central position, and remain stationary. The AFS warning indicator will illuminate to indicate that a fault is present. If the warning indicator illuminates, contact your Jaguar Dealer/Authorised Repairer as soon as possible.

Lighting

DIRECTION INDICATORS

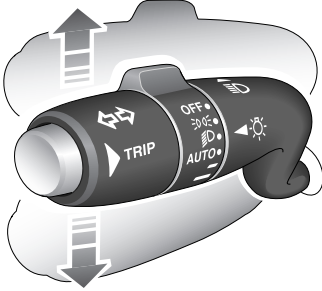

E91163

The direction indicators are operated using the indicator stalk. Move the stalk up or down, to indicate a right or left turn. A green warning indicator will flash in the instrument panel.

The indicators will operate three times (e.g. to indicate a lane change) if the stalk is briefly pushed up or down. This feature can be disabled or enabled by a Dealer/Authorised Repairer.

Note: Should a direction indicator bulb fail, the corresponding green warning indicator will flash at twice the normal rate and the audible ticking will sound at twice the normal rate.

INTERIOR LAMPS

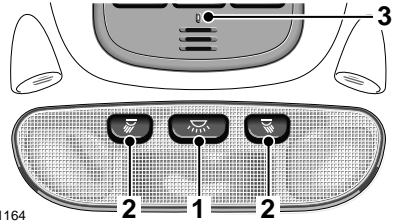

E91164

1. Courtesy lamp and footwell lamps.
2. Left and right-hand reading and map lamps.
3. Centre console illumination.

Interior lighting comprises, front overhead courtesy lamps, two front reading and map lamps and front puddle lamps. Vanity mirrors, glove compartment, footwell and luggage compartment lamps are also provided.

Press the centre switch (1) in the front roof console to turn the courtesy lamps, puddle lamps and footwell lamps on. A second press turns the lamps off. The lamps also operate to illuminate the vehicle interior when a door is opened.

The interior courtesy lamp and footwell lamps can be de-activated by pressing the centre switch for more than two seconds. The courtesy lamp will flash, then switch off.

The courtesy lamp and footwell lamp will come on again when the lamp switch is pressed again for more than two seconds.

The centre console area is illuminated by a small lamp from the overhead console (3). This is on whenever the side lamps are on and can be controlled by the dimmer switch.

Reading Lighting

The reading and map lamps are turned on and off by individual switches (2) on the front overhead console.

Lighting

Illuminated entry and exit

The interior lamps will gradually illuminate when a door is opened and go out when the engine is started or approximately 30 seconds after the last door is closed. If any door is left open, the lamps will fade off approximately 15 minutes after returning from convenience mode to power off.

When the vehicle is unlocked, the courtesy lamps will come on at maximum brightness for approximately 30 seconds, if a door is not opened.

With the engine running, opening any door will put on all interior lamps, they will go out immediately after the last door is closed.

Glove compartment

The glove compartment will illuminate when opened.

Luggage compartment lighting

The luggage compartment will be illuminated when opened.

Battery saver

To prevent battery discharge, the interior, glove compartment, luggage compartment, reading, map and vanity lamps will automatically turn off after approximately 15 minutes, once the ignition is turned off.

CONVENIENCE HEADLAMPS



This feature is activated by pressing the headlamp icon button on the Jaguar Smart Key. See

USING THE JAGUAR SMART KEY (page 16).

The headlamps will remain on for 25 seconds or until the button is pressed again, or until the engine START/STOP button is pressed.

Lighting

CHANGING A BULB

General information

CAUTION



Always replace bulbs with the correct type and specification. If you are in any doubt contact your Jaguar Dealer/Authorised Repairer for advice.



Seek advice about the correct disposal of Xenon lamp units from a Jaguar Dealer/Authorised Repairer, or your local authority.

The message centre will display a message indicating which bulb requires to be replaced.

Before renewing bulbs, switch off the ignition system and lamp switches.

To change the bulbs within the headlamp and tail lamp, the complete units require to be removed from the vehicle.

Note: In most countries it is illegal to use a vehicle with a defective exterior lamp bulb.

Headlamp unit

WARNINGS



Replacement or maintenance of Xenon lamps should be carried out by a Jaguar Dealer/Authorised Repairer.



Used Xenon lamp units contain mercury which is hazardous and can be injurious to health.



Xenon lamp units operate at a high temperature. If they have recently been in use, allow sufficient time for them to cool down before touching them.



The Xenon system generates up to 28,000 volts and contact with this voltage could lead to a fatality. Ensure that headlamps are switched off before working on the system.

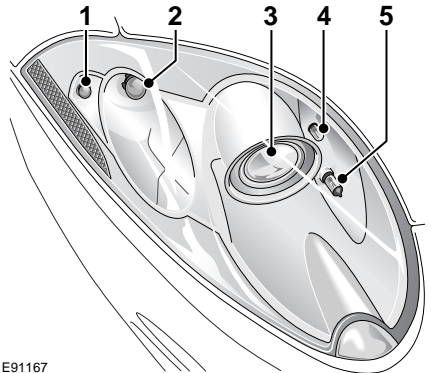

E91167

1. Side marker.
2. Direction indicator.
3. Low and high beam projector unit.
4. Side lamp.
5. Cornering lamp.

Lighting

Removal of the headlamp unit

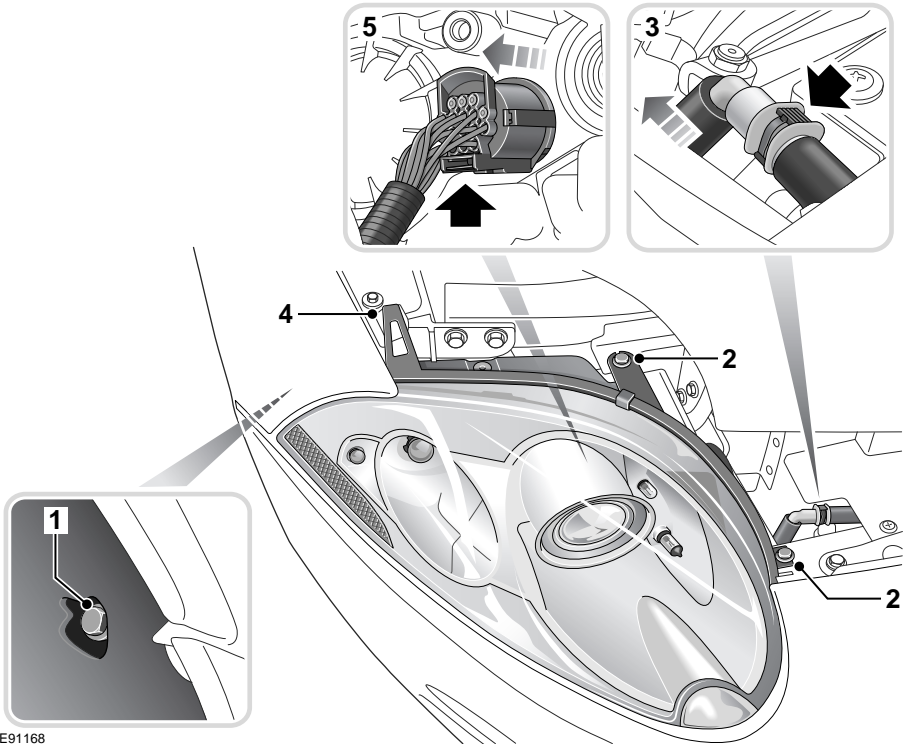

E91168

1. Remove the lower headlamp securing bolt located in the front of the wheel arch.
For improved access, turn the steering wheel to the left when removing the right-hand headlamp, and to the right when removing the left-hand headlamp.
2. Open the bonnet and remove the upper securing bolts.
3. Disconnect the headlamp powerwash connector by pressing the button and pulling the pipe apart, some washer fluid may drain from the pipe when it is disconnected.
4. Release the headlamp locating peg by lifting the tongue upwards.
5. Carefully ease the headlamp unit forward, to gain access to the wiring multi-plug connector. Release the connector by pressing upwards on the release button and pull the wiring multi-plug from the headlamp. Place the headlamp unit on a flat surface covered in a soft material to prevent damage to the lens.

Lighting

Refitting the headlamp unit

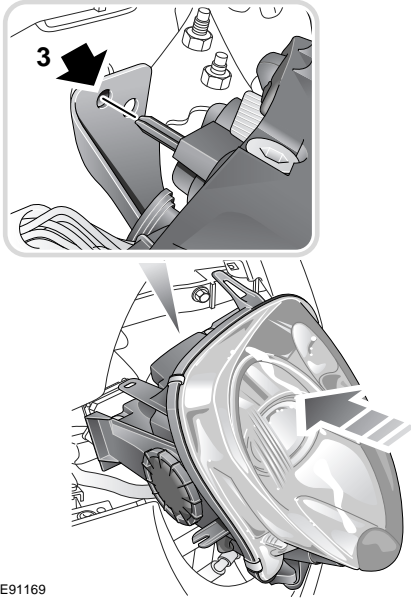

E91169

1. Reconnect the wiring multi-plug connector.
2. Offer up the unit into position.
3. Ensure that the locating peg is fitted into the in-board locating hole.
4. To secure the headlamp unit, first secure the wheel arch screw, then repeat the removal procedure in the reverse order, ensuring that the powerwash pipe is reconnected.

Note: After the replacement of any bulb and the fitting of the headlamp unit, the aim of the headlamps should be checked by a Jaguar Dealer/Authorised Repairer.

Front direction indicator lamp

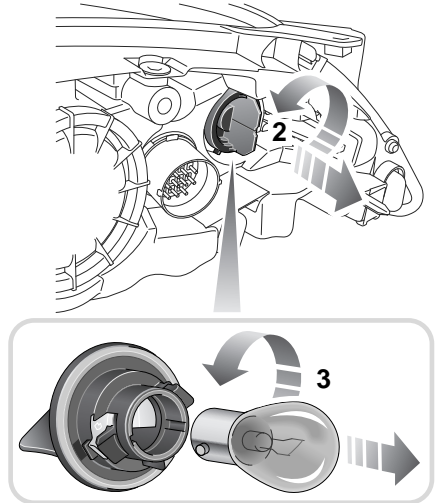

E91171

1. Remove the headlamp unit.
2. Twist the bulb holder counterclockwise and pull out the bulb complete with the electrical connector.
3. Twist and pull the bulb out of the bulb holder.
4. Insert the new bulb (PY21W) and repeat the above procedure in reverse order.

Lighting

Side lamp

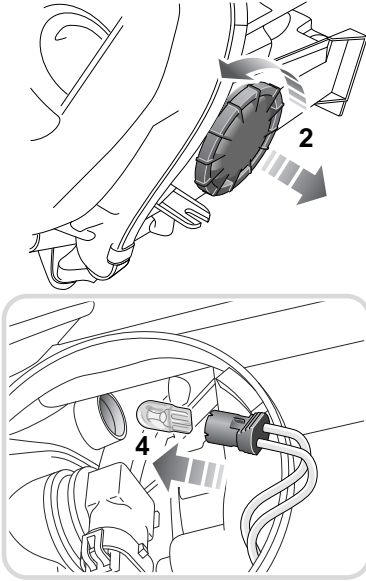

E91172

1. Remove the headlamp unit.
2. Twist and lift off the side domed cap.
3. Pull out the bulb complete with bulb holder.
4. Pull the bulb out of the bulb holder.
5. Insert the new bulb (W5W) and repeat the above procedure in the reverse order. Ensure that the cover is fitted correctly to retain the water tightness.

High and low beam projector unit

CAUTION

! It is strongly advised that the High Intensity Discharge (HID) Xenon low and high beam projector unit (D1S35W) should be replaced by a Jaguar Dealer/Authorised Repairer.

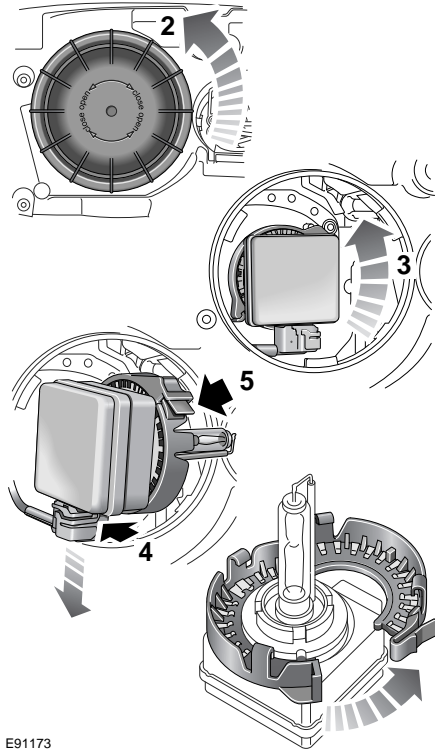

E91173

1. Remove the headlamp unit.
2. Twist and lift off the rear domed cap.
3. Twist the bulb unit counterclockwise to unlock it. Pull the bulb unit clear of the headlamp unit.

Lighting

4. Press the electrical connector release lever and disconnect the bulb unit.
5. Press the bulb unit adaptor ring catch and remove the adaptor ring from the bulb unit.
6. Secure the bulb unit adaptor ring onto the new bulb (D1S35W) and repeat the above procedure in the reverse order. Ensure that the cover is fitted correctly to retain the water tightness.

Cornering or static bending lamp

CAUTION

! Halogen bulbs will be damaged if touched by hand or contaminated with oil or grease. It is important to use clean gloves or lint free cloth when handling a bulb which is to be used again. A contaminated bulb may be cleaned with methylated spirit before refitting.

1. Remove the headlamp unit.
2. Twist and lift off the side domed cap.
3. Twist the bulb holder counterclockwise to unlock, then pull out the bulb complete with electrical connector.
4. To release the bulb unit, lift the two catches of the electrical connector, then pull to remove the bulb unit.
5. Insert the new bulb unit (H8) and repeat the above procedure in the reverse order. Ensure that the cover is fitted correctly to retain the water tightness.

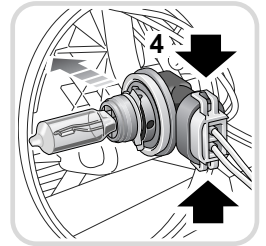
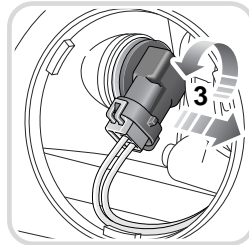
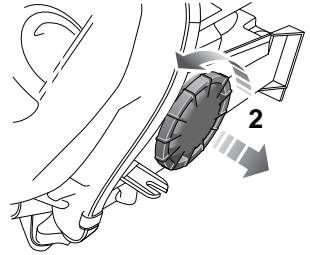

E91174

Side repeater lamp

CAUTION

! These lamps are LED units and should only be replaced by a Dealer/Authorised Repairer.

Lighting

Number plate lamp

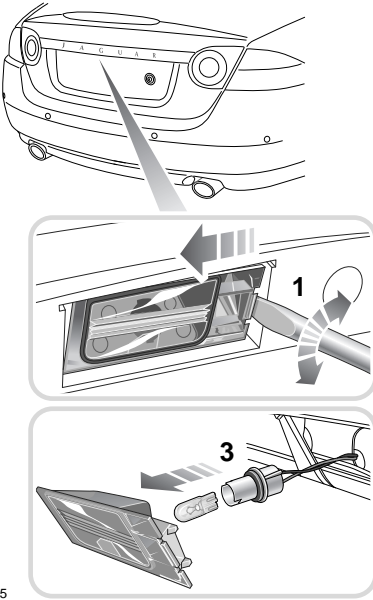

E91175

1. Insert a wide flat bladed suitable tool, twist and lever the lens out of the surround panel. Ensure that the lens moves to the outer edge of the surround panel to release the securing tabs.
2. Twist and pull out the bulb holder complete with bulb.
3. Pull the bulb out of the bulb holder.
4. Insert the new bulb (W5WL).
5. Refit the lens by locating the outboard securing tabs first and then pressing it firmly into the recess until it clicks.

Rear lamp unit

CAUTION

- ! These lamps are LED units and should only be replaced by a Dealer/Authorised Repairer.

The rear lamp unit contains the following lamps:

- Tail lamps.
- Brake lamps.
- Rear fog lamps.
- Rear direction indicators.
- Rear side marker lamps.
- Reverse lamps.
- High level brake lamp.

BULB SPECIFICATION CHART

CAUTION

- ! Before attempting to replace a bulb make sure that both the affected lamp and the vehicle's ignition system are turned off. If the circuit is live a short circuit can occur which may damage the vehicle's electrical system.

Lamp	Specification	Power (Watts)
Xenon headlamp Low and High beam.	D1S35W	35
Front side lamps.	W5W	5
Front direction indicators.	PY21W	21
Cornering lamps.	H8	55
Number plate lamps.	W5WL	5

Wipers and washers

WINDSCREEN WIPERS

CAUTIONS

- ❗ Do not operate the windscreen wipers on a dry screen. The drag on the wiper mechanism may cause damage.
- ❗ In freezing or very hot conditions ensure that the wipers have not stuck to the windscreen before operating. The drag on the wiper mechanism may cause damage.
- ❗ Remove any snow, ice or frost from the windscreen, around the wiper arms and blades and the screen scuttle before operating the wipers. Snow and ice can cause damage to the wiper mechanism if not cleared.

Note: If the wiper blades become stuck or jammed, an electronic cut-out may temporarily stop the wipers. If this happens, switch off the wipers and the ignition. Clear any obstructions and free the wiper blades, before attempting to switch on the ignition.

Wiper operation

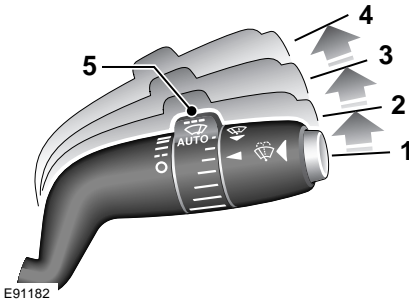

1. Windscreen wipers off and parked.
2. Intermittent wipe.
3. Normal wipe speed.
4. Fast speed wipe.
5. Intermittent wipe rotary collar.

Intermittent variable delay

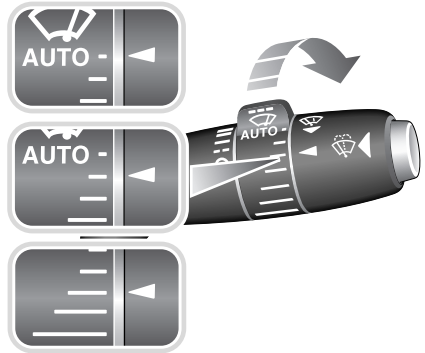

E91183

When intermittent wipe (2) is selected, the delay between wipes can be varied by turning the rotary collar (5) to the required delay position. Rain sensor wiper operation is selected by turning the collar to **AUTO**.

Note: If configured, the delay period for each collar position (excluding AUTO), automatically increases and decreases with vehicle speed.

Flick wipe

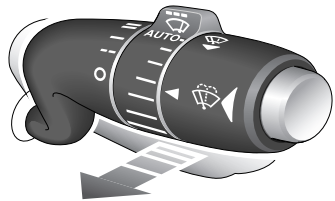

E91184

Pull the stalk towards the steering wheel for a single wipe. Holding the stalk in this position will operate the wipers continuously at normal speed until released.

Wipers and washers

Speed dependent mode

If speed dependent mode is configured, the operation of all wiper modes will be affected by the vehicle speed.

Speed dependent mode becomes active when the wipers are operating and the vehicle speed exceeds 10 km/h (6 mph). If the vehicle subsequently comes to a stop, the wiper automatically changes to the next lowest operating speed. When the vehicle starts moving again, the original wiper speed setting is automatically restored.

Speed dependent mode can be configured by your Jaguar Dealer/Authorised Repairer.

RAIN SENSOR

CAUTIONS

! Ensure that AUTO is not selected when entering a car wash or damage to the wiper blades or arms can occur as they will operate in the car wash.

! During frosty conditions ensure that AUTO is not selected before operating the ignition system as damage to the wiper blades can occur when the windscreen is frozen.

When AUTO and intermittent wipe (2) are selected, the wipers will automatically operate when rain falls on to the windscreen, or when moisture is present.

For the wipers to operate, the ignition must be on.

Note: When starting a journey with a wet windscreen, the rain sensing wipers may not operate immediately when the ignition is switched on. Therefore, a flick wipe should be used to clear the windscreen of any moisture.

WINDSCREEN WASHERS

WARNING



Some screenwash products are flammable, do not allow screenwash to come into contact with sources of ignition.

CAUTION



Only screenwash products which are approved for automotive use should be used, and only in accordance with the manufacturer's instructions.

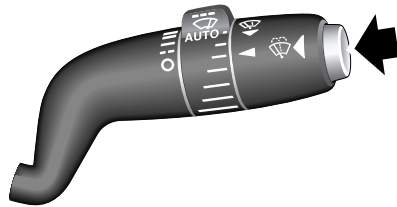

Program wash and wipe

Timed jet function: If timed jet function is configured, the windscreen washer jets (located on the wiper arms) only spray on the up stroke of the wiper arms. This function can be configured by your Jaguar Dealer/Authorised Repairer.

With the stalk in the OFF or intermittent position, the program wash and wipe sequence is activated by pushing the button on the end of the column switch.

Short press: The wipers will perform five normal speed wipes, followed by a drip wipe. The washer jets will spray on the first two wipes.

Wipers and washers

Extended press: The wipers and washers will operate continuously at normal speed until the button is released. When released, the wipers will complete their current wipe and then complete three further wipes, followed by a drip wipe.

Drip wipe: If drip wipe is configured, following completion of the program wash and wipe cycles, the wipers will pause for four seconds then complete a drip wipe to clear any remaining drips from the windscreen.

This function can be configured by your Jaguar Dealer/Authorised Repairer.

Washer

If normal or fast wipe is selected, pressing the program wash and wipe button will operate the washer jets.

- Short press: The washer jets spray for two wipes.
- Extended press: The washer jets spray until the button is released or a 10 second timer has elapsed.

Note: *If the button is pressed during the up-stroke of the wipers, the washer jets may spray for the completion of that wipe, prior to spraying for the required number of wipes or duration.*

If the rotary collar is set to **AUTO**, the wipers will operate until no moisture is detected.

Note: *If the low washer fluid warning is on, the windscreen wipers will not operate when program wash and wipe is activated even though there may be washer fluid remaining in the reservoir and sprayed onto the screen. This is to prevent damage to the blades, scratching of the glass, or smearing dirt across the screen. Flick wiper, normal or fast operation, can be selected to clear any spray from the windscreen.*

HEADLAMP WASHERS

Note: *Telescopic headlamp powerwash units are contained within the front headlamp units.*

If the ignition system is on, dipped beam headlamps are switched on and there is sufficient fluid in the washer reservoir, pressing the program wash and wipe button will also operate the headlamp powerwash; directing two short bursts of washer fluid onto the headlamps.

After the first headlamp powerwash operation, the headlamp powerwash will operate on every fourth press of the program wash and wipe button, provided that the headlamps are still switched on and a 10 minute timer has elapsed since the last headlamp powerwash.

Note: *The powerwash sequence is reset when the headlamps or ignition is turned off and on again.*

Note: *The headlamp powerwash function is inhibited when the low washer fluid warning is on.*

Wipers and washers

CHECKING THE WIPER BLADES

WARNING



Only use cleaning products which have been approved for use on automotive glass and rubber.

Inappropriate products can cause smearing, and increase glare.

Grease, silicone and petrol-based products impair the blade's wiping capability.

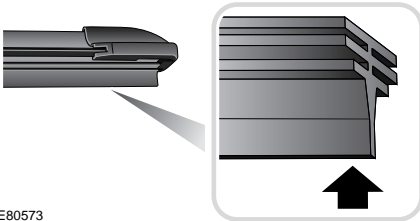

The wiping edge of the blades should be checked, and cleaned periodically. Lift the wiper blades clear of the windscreen and wipe the blades with a clean, soft cloth moistened with warm water mixed with a mild liquid detergent.

If signs of hardness or cracking in the rubber are found, or if the wipers leave streaks or unwiped areas on the windscreen during use, then the wiper blades should be replaced immediately to prevent damage to the glass.

Note: *The wiper arms have a restricted lift of 10 degrees.*

Use Jaguar Screen Clean Paste to remove contamination from the windscreen to ensure effective wiping or if smearing or juddering becomes evident.

A more aggressive cleaning agent may be required to remove stubborn contamination. You should contact a Jaguar Dealer/Authorised Repairer for advice.

CHANGING THE WIPER BLADES

Only fit replacement wiper blades that are identical to the original specification.

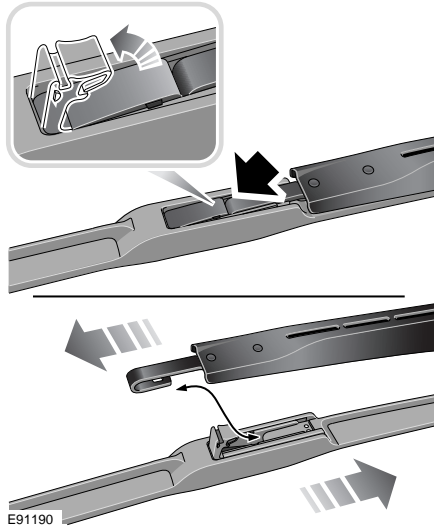

Lift the locking tab to release the blade assembly and slide the wipe assembly off the end of the wiper arm. Carefully replace the wiper arm assembly to its stowed position.

To replace the wiper blade, position the wiper arm into the aperture in the middle of the new blade assembly and fully locate the blade into the wiper arm. Push the lock tab firmly into position so that the wiper blade is locked into the wiper arm.

Windows and mirrors

ELECTRIC WINDOWS

WARNINGS



Before operating power windows you should verify they are free of obstructions and ensure that children and or pets are not in the proximity of window openings. Failure to do so could result in serious personal injury. It is the primary responsibility of the supervising adults to never leave a child unattended in a vehicle.



When raising windows ensure all occupants are clear.



When leaving the vehicle take the ignition keys to prevent misuse of the window switches by remaining occupants, especially children.

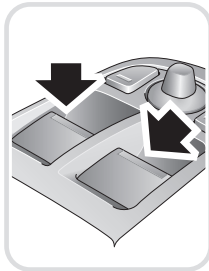

JAG1555



The ignition system requires to be on to operate the windows.

The driver and passenger door windows are controlled by switches in the driver's door control panel. The passenger door window can also be operated using the switch in the passenger door control panel.

The windows will operate for five minutes after the engine is switched off, provided neither door is opened.

Raise and lower

To lower a window, press and hold the front of the switch until the desired position is reached, then release.

To raise a window, pull up and hold the front of the switch until the desired position is reached, then release.

Release the switch at any point to stop window movement.

If the switches are held for longer than six seconds (e.g. when attempting to overcome frozen or jammed windows), the window drive will be switched off for a few seconds to protect the window drive motors.

One-touch operation

Each window has a one-touch facility enabling the occupant to fully open or close the window in one quick movement.

Press (or pull) the switch briefly to open (or close) the window in one movement. Window travel can be stopped at any time by operating the switch again.

Automatic window drop for door opening

The frameless door windows create a seal against the convertible top or the roof seals. If fully raised, the door windows will drop partially when the door release lever is operated, this is to allow easy door opening. When the door is closed the windows rise to the fully closed position.

The doors must not be opened if power for automatic window drop is not available (e.g. with battery disconnected). However, in an emergency the doors can be opened with the windows fully up.

Windows and mirrors

Window anti-trap protection

WARNING



If the battery is disconnected or discharged the window anti-trap protection feature is lost. When the battery is reconnected or recharged the window anti-trap protection system must be reset.

Each electrically operated window has an anti-trap protection feature. If the upward movement of the window detects an obstacle the anti-trap detection system will immediately stop the window closing, then move it downwards for a short distance.

Anti-trap protection override

WARNING



While the window is being closed for the third time, the anti-trap detection function is disabled. Make sure there are no obstacles in the way of the closing window.

The anti-trap protection will also stop the window closing if a blockage or resistance occurs (e.g. in the window guide channels).

Typically this might be due to icing in winter but could also be caused by damage or misalignment of the guide channels or seals.

- After the initial attempt to close the window and the anti-trap detection has initiated, operate the close switch a second time. This action must be carried out within 10 seconds.

- The window will attempt to close again and operate the anti-trap detection. The window will now close again for the third time, but will only operate by pressing and holding the switch with the anti-trap detection disabled. The window will now close with full power. The icing in the seal can now be broken and dispersed.
- Repeat the override action until the window has closed. Each time the window stops, the switch must be operated immediately to initiate further override action.

If this procedure fails to move the blockage, the anti-trap detection feature will be lost and must be reset after the blockage has been cleared.

Reset window anti-trap protection

Ensure that the respective door is closed and, if fitted, the convertible roof closed.

- Fully close the window, then release the switch. Again pull the switch to close the window and hold for two seconds.
- Open the window fully and release the switch. Again press the switch to open the window and hold for two seconds.
- Check to confirm the operation by opening the window and then use one-touch operation to close the window.
- Repeat for the remaining electrically operated windows.

Thermal overload

If the windows are repeatedly opened and closed (e.g. by a child), a protection system will deactivate window operation for a short period to avoid overheating of the window motors.

Windows and mirrors

CAUTION



Do not close the door with the windows fully up as damage to the seals and the glass will occur.

Rear quarter window operation (Convertible only)

The rear quarter windows operate automatically in conjunction with convertible roof opening or closing.

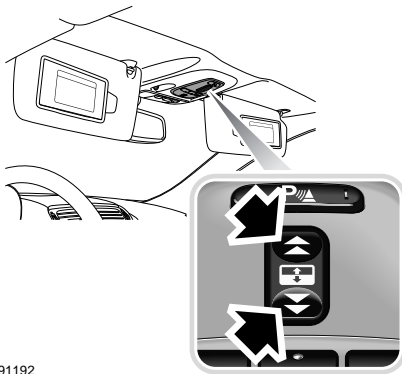

E91192

The rear quarter windows may also be operated independently of the convertible roof when the convertible roof is closed, by means of the convertible roof switch on the overhead console, as follows:

To lower: Press the rear of the switch for less than a second and the rear quarter windows will be driven down fully.

To raise: Press the front of the switch and hold and the rear quarter windows will rise for as long as the switch is held.

Note: When the convertible roof is opened, the rear quarter windows are automatically lowered and cannot be operated until the roof is closed. When the roof is closed, the rear quarter windows are automatically raised.

Note: The rear quarter windows operate together and cannot be operated individually.

Window tinting

CAUTION



Do not have your vehicle windows tinted with a metal oxide tinting (for maximum heat reduction from the sun), if you have a telephone or navigation system fitted to your vehicle.

Metal oxide tinting prevents the reception of the Global Positioning System (GPS) signals by the antenna, causing the navigation system to stop functioning.

A non-metal tinting should be used if you require window tinting and if in doubt, contact your Jaguar Dealer/Authorised Repairer for advice.

Windows and mirrors

EXTERIOR MIRRORS

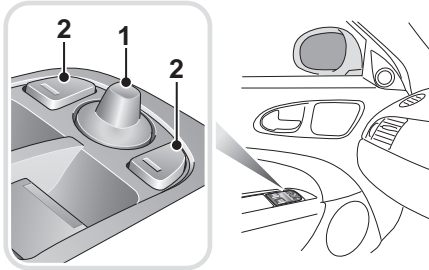

JAG1556

Both door mirrors are adjusted from the driver's door control panel.

The four-way adjustment button (1) moves the mirrors to the required position. The selector button (2) selects the mirror to be adjusted.

Note: *Dependent on market requirements, both exterior mirrors are convex, providing a wider field of vision. As a result, objects viewed in the mirrors are closer than they appear.*

The mirror housings are designed to pivot against the vehicle upon impact. If this should occur, reposition powerfold mirrors using the door switch buttons.

Mirror heating

CAUTION



Do not use a scraper to remove ice from the mirrors as this will damage the surface.

The door mirrors have heating elements which operate automatically based on the external ambient temperature of the vehicle. The mirror heater will clear all ice from the mirror surface.

Mirror dip when reversing

Reverse mirror dipping is selected via the touch-screen.

From the main Home menu, select **Vehicle**:

- Select **Veh. settings**.
- The **Security** screen is selected automatically as the default.

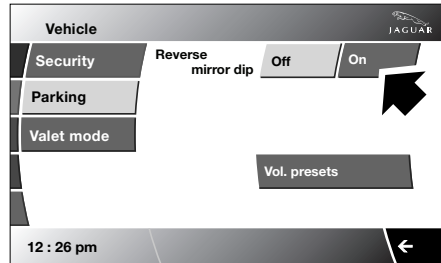

E91195

- Select **Parking**.
- Select **Reverse mirror dip On**.

When reverse gear is selected, the passenger mirror inclines downwards to provide a close up view of the rear side area. When the gear selector is moved out of reverse, the mirror will return to its original position.

The reverse mirror dip alignment can be adjusted by using the four-way adjustment button (1) when the mirror has completed movement to its reverse dip position. This new selected position is maintained until re-adjusted.

Note: *When reversing, if a speed of greater than 7 km/h (4 mph) is achieved, then the mirrors will revert to the previous position. However, if the speed is then reduced to below 7 km/h (4 mph), then the mirrors will revert to the dipped position.*

Windows and mirrors

Mirror powerfold

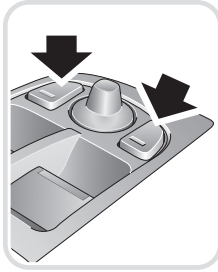

JAG1557

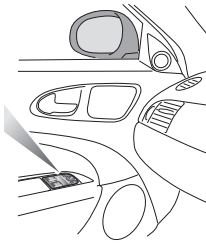

WARNING



Do not drive the vehicle with the door mirror in the folded position, except when parking.

To assist parking by reducing the overall vehicle width, a selectable facility enables the door mirrors to be folded back.

To fold the mirrors, press both left and right-hand mirror selector buttons at the same time. The mirrors automatically stop in the fully folded position. Press both buttons again to unfold the mirrors.

Powerfold and unfold can be cancelled by pressing both mirror selector buttons again, while the mirrors are folding/unfolding.

Note: If the button is pressed repeatedly, a thermal cut-out will prevent damage to the vehicle's electronics. If this occurs, wait for five minutes for the cut-out to reset, before operating the button.

Note: If the thermal cut-out operates and leaves the mirrors in the folded position, the mirrors can be folded outwards manually.

Note: If the door mirrors are repositioned manually (or knocked out of position), the mirror head will be loose. To re-engage the mechanism, power the mirror to the foldback position, then outwards to the drive position.

Note: Mirror foldback will only activate when the vehicle is stationary or travelling at 20 km/h (12 mph) or less.

Note: The door mirrors will not unfold automatically when the Jaguar Smart Key unlock button is pressed, if they have been folded via the door mirror switches.

Automatic powerfold

The mirrors can be configured to automatically fold when the vehicle is locked and unfold when unlocked.

Note: If the mirrors were folded using the switches, they will not unfold automatically when the vehicle is unlocked.

To select automatic mirror powerfold via the touch-screen:

From the main Home menu, select **Vehicle**:

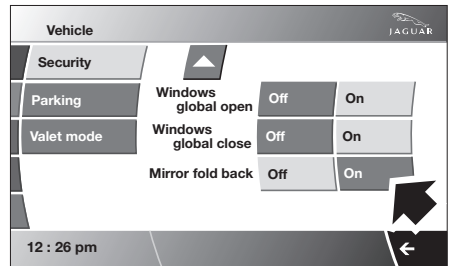

JAG1422

- Select **Veh. settings**.
- The **Security** screen is selected automatically as the default.
- Select **Mirror fold back On** or **Off**.

Windows and mirrors

INTERIOR MIRROR

Auto dimming

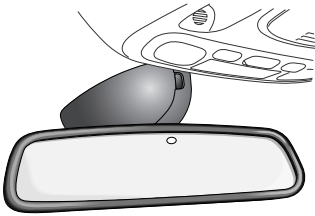

E91200

The interior mirror dimming is adjusted automatically according to the amount of ambient light when the ignition is on. If reverse gear is selected, the automatic dimming feature is turned off to allow maximum visibility for reversing.

Note: If the mirror becomes detached from the windscreen it should be re-attached by a Jaguar Dealer/Authorised Repairer.

Note: Ensure that the windscreen in front of the mirror is kept clean. Where fitted, the rain sensor for wiper operation is located to the front of the mirror casing. Any dirt may affect the operation of this sensor.

Note: The automatic darkening of the mirror will not operate properly if the light that would otherwise strike the mirror is obstructed.

Interior mirror (with compass)

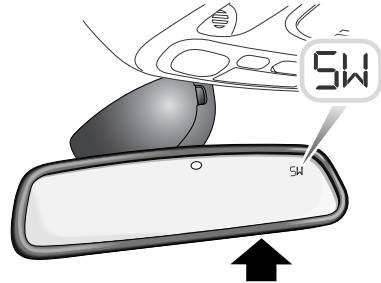

E91201

When switched on, the compass display on the right-hand side of the mirror surface shows the direction the vehicle is pointing. Eight main directions can be displayed, e.g. N for North, SW for South-West etc.

Setting the compass

With the ignition system on, depress and hold the button under the mirror. The setting that is accessed is dependent on how long the button is pressed, as follows:

- 0 to 2 seconds, the display will be blank.
- 3 to 5 seconds, use this to set the zone for geographic location.
- 6 to 8 seconds, will cause the compass to RESET the calibration of the compass. The letter **C** will be displayed in the mirror.
- 9 seconds will set either **L** for left-hand drive or **R** for right-hand drive.

Windows and mirrors

Calibrating the compass

If **C** is displayed in the compass window instead of the direction, or if the compass displays the wrong heading even when the compass variance zone is correctly set, the compass must be calibrated.

Note: *The compass may not indicate the correct compass point in tunnels or whilst driving up or down a steep hill (the compass will show the correct reading when the vehicle moves to an area where geomagnetism is stabilised).*

Find a large open space away from traffic, for example an empty car park.

Start the engine and depress and hold the button under the mirror for approximately 6 to 8 seconds until a **C** appears in the compass display.

Drive the vehicle in a complete circle, 360 degrees, at less than 10 km/h (5 mph) until a direction of travel appears in the compass display.

Alternatively, you can calibrate the compass by driving your vehicle on your everyday routine. Calibration will be completed once the vehicle has completed a full circle.

The calibration process is now complete.

Holding the button depressed for longer than nine seconds enables left-hand drive (**L**) or right-hand drive (**R**) to be set.

Inaccurate compass direction

With the ignition on, push the button for 3 to 5 seconds until the Zone selection is shown (a number will be displayed in the mirror compass).

Now press the button repeatedly until the appropriate variance zone number (from the map illustration that follows) appears in the compass display.

The compass is now set to your new location and will give a steady direction heading after about five seconds.

If adjusting the zone setting did not correct the compass heading error, or if the zone was already correctly set for your area, then the compass must be recalibrated.

Windows and mirrors

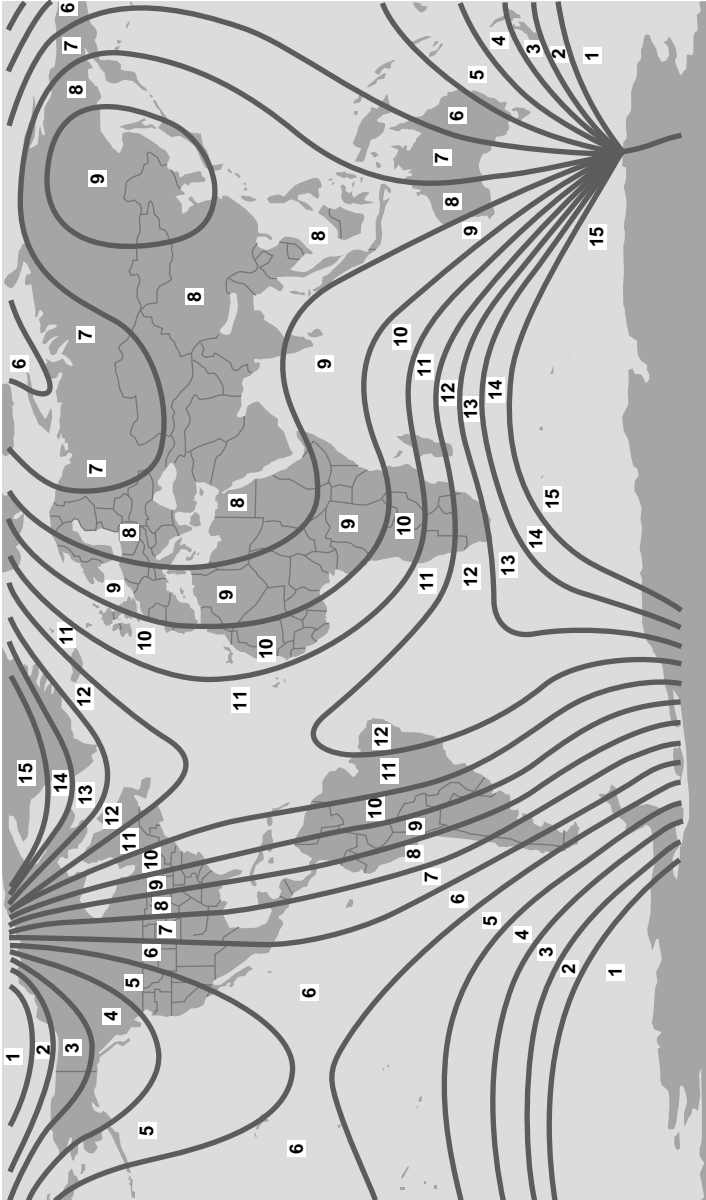

E91202

Instruments

INSTRUMENT PANEL OVERVIEW

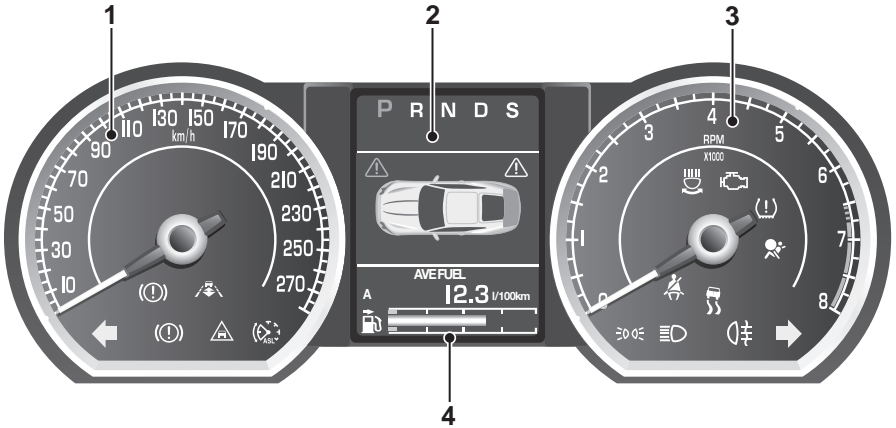

JAG1360

1. Speedometer.
2. Message centre.
3. Tachometer.
4. Fuel gauge.

None of the instruments will show correct indications until the ignition system turned on.

Speedometer

Speed indication is in either:

- Miles per hour and kilometres per hour or;
- Kilometres per hour only.

Message centre

Displays warnings and information messages by the vehicle systems.

Message centre illumination

The message centre is lit at all times when the ignition is on. See **KEYLESS STARTING** (page 132).

Tachometer

Indicates engine speed in revolutions per minute (x 1 000) and is calibrated in increments of 250 rev/min.

CAUTION



Do not allow the needle to enter the red sector.

Fuel gauge

The small arrow on the top of the fuel pump symbol denotes which side of the vehicle the fuel filler cap is located.

The message centre will display the message **FUEL LEVEL LOW** when the fuel level is approximately 1/16 tank capacity, approximately a distance range of 48 to 64 km (30 to 40 miles).

Instruments

WARNING LAMPS AND INDICATORS

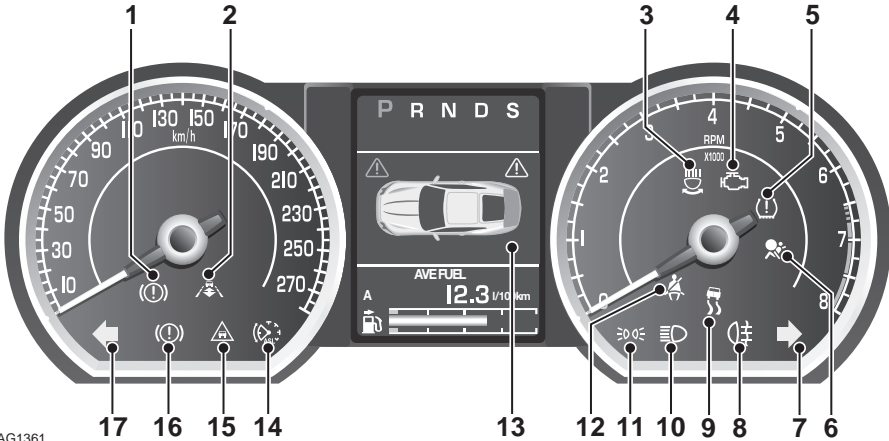

JAG1361

1. Anti-lock Braking System (ABS).
2. Adaptive Cruise Control (ACC).
3. Adaptive Front lighting System (AFS).
4. Engine malfunction.
5. Tyre Pressure Monitoring System (TPMS).
6. Airbag.
7. Right-hand direction indicator.
8. Rear fog light.
9. Dynamic Stability Control (DSC).
10. High beam.
11. Side lamps.
12. Seat belt.
13. Message centre.
14. Automatic Speed Limiter (ASL).
15. Forward alert.
16. Electric Parking Brake (EPB) on/Brake fluid low/Electronic Brakeforce Distribution (EBD).
17. Left-hand direction indicator.

RED warning indicators are for primary warnings. A primary warning must be investigated immediately by the driver or seek qualified assistance as soon as possible.

AMBER warning indicators are for secondary warnings. Some indicate that a vehicle system is in operation, others indicate that the driver must take action and then seek qualified assistance as soon as possible.

Other indicators within the instrument panel indicate system status, such as blue for main beam and green for direction indicators, when in operation.

Indicator check

A lamp check is initiated when the ignition is turned on and lasts for three seconds (except the airbag warning indicator which will remain on for six seconds). If any warning indicator remains on after this period, investigate the cause before driving.

Some warning indicators have associated messages displayed on the message centre.

Instruments

Note: Not all lamps are included in the lamp check, for example main beam headlamps or direction indicators.

Brake (Red)

WARNING



If the message **LOW BRAKE FLUID** is displayed, check the brake fluid level and top-up as necessary. Do not drive the vehicle until the brake fault is rectified. Seek qualified assistance before continuing.



Illuminates when the ignition system is on and the parking brake is applied and/or the brake fluid is low. The indicator will also illuminate when there is a fault with the Electronic Brakeforce Distribution (EBD) system.

If the indicator is illuminated and there are no associated messages, it means that the parking brake is applied.

If the indicator flashes, there is a fault with the parking brake system and the parking brake cannot be applied.

If the indicator is illuminated and the message **PARK BRAKE ON** is displayed, it means that the parking brake is applied but the vehicle is moving. Release the parking brake or stop the vehicle when it is safe to do so.

If the indicator is illuminated and the message **LOW BRAKE FLUID** with a red priority lamp is displayed on the message centre, low brake fluid is indicated. In this case, loss of braking in one or both brake circuits may be imminent. Stop the vehicle gently and check and top-up the brake fluid reservoir, using the recommended fluid. If the warning message remains, do not drive the vehicle until the brake fault is rectified. Seek qualified assistance before continuing. See **BRAKE FLUID CHECK** (page 187).

If the indicator is illuminated and the message **EBD FAULT** (with red backlight) is displayed in the message centre, a fault with the EBD system is indicated. Stop the vehicle gently, as soon as safety permits and seek qualified assistance.

Seat belt (Red)



The warning indicator illuminates when the ignition is on and also illuminates to signify the following:

- The driver's seat belt is not fastened.
- A passenger is sitting in the front seat and their seat belt is not fastened.

The indicator lamp should go out when the driver's seat belt is fastened (and the front passenger's, if the seat is occupied).

Instruments

Beltminder (Red)



The beltminder feature, which uses the same indicator as the seat belt warning, provides reminders to the driver that the driver's and/or front passenger's seat belt is unbuckled.

If the vehicle is moving at or above 16 km/h (10 mph) and the seat belt of an occupied front seat is not fastened, the indicator lamp will flash.

The flashing will last for ten seconds and then repeat every 30 seconds for approximately five minutes or until the belt(s) is fastened or the vehicle stops.

If the warning indicator stays on with the seat belt(s) fastened, seek qualified assistance as soon as possible. It is safe to drive the vehicle with the lamp on, provided that the seat belt(s) is properly fastened.

Ensure that all occupants fasten their seat belt before driving.

Note: *If a heavy object is placed on the front passenger seat, it may activate the Beltminder feature. It is recommended that the object be placed in the luggage compartment or is secured on the seat using the seat belt.*

Anti-lock Braking System (ABS) (Amber)

WARNING



If the ABS and brake warning indicators are on at the same time, do not drive the vehicle until the fault is rectified. Seek qualified assistance immediately.



Illuminates if a fault has been detected in the ABS (accompanied by a warning message in the message centre).

The brake system will continue to function normally, but without ABS braking.

If the warning indicator illuminates or stays illuminated after the bulb check cycle, seek qualified assistance as soon as possible.

Adaptive Front lighting System (AFS) (Amber)



Illuminates when there is a system fault. Seek qualified assistance as soon as possible.

Engine malfunction (Amber)



Illuminates when the ignition is on and remains illuminated until the engine is started.

If the indicator illuminates when the engine is running, an engine malfunction has occurred.

Specialised diagnostic equipment is required to repair such faults. Seek qualified assistance as soon as possible.

The vehicle may go to limp-home mode, with the possibility of reduced engine performance.

Drive with caution. See **AUTOMATIC TRANSMISSION** (page 133).

Instruments

Dynamic Stability Control (DSC) (Amber)



The indicator will flash twice every second when DSC is operating.

The message **DSC NOT AVAILABLE** will be displayed and the indicator lamp illuminates continuously if a fault is detected.

When TracDSC is selected, the message **TRAC DSC** is displayed for four seconds and the warning indicator remains illuminated.

When DSC is switched off, a chime will sound, the message **DSC OFF** is displayed in the message centre and the warning indicator remains illuminated.

Rear fog lamp (Amber)



Illuminates when the rear fog lamp is switched on.

Adaptive Cruise Control (ACC) (Amber)



Illuminates when adaptive cruise control is active to indicate that the vehicle is in follow mode.

Forward alert (Amber)



Illuminates when the forward alert function is active.

Airbag (Amber)



Flashes if the airbag system or the Rollover Protection System (Convertible only) develops a fault, then illuminates continuously until the fault has been diagnosed and cleared.

Seek qualified assistance as soon as possible.

Tyre Pressure Monitoring System (TPMS) (Yellow)



Illuminates when one or more tyres are significantly under-inflated. The vehicle should be stopped as soon as possible and the tyres checked and inflated to the recommended pressure.

The indicator flashes when a fault with TPMS is detected. See **TYRE PRESSURE MONITORING SYSTEM** (page 214).

High beam (Blue)



Illuminates when the headlamps are switched to high beam or flashed.

Automatic Speed Limiter (ASL) (Green)



Illuminates when Automatic Speed Limiter is active.

Side lamps (Green)



Illuminates when the side (parking) lamps are switched on.

Direction indicators (Green)



The appropriate indicator will flash when the column stalk is moved up or down to signal a turn. If a direction indicator bulb fails, the audible ticking and lamp will sound and flash at twice the normal rate when that indicator is selected.

Hazard warning indicators

When the hazard warning switch is used, both direction indicators flash simultaneously, in conjunction with the hazard warning lamp switch illumination.

Instruments

AUDIBLE WARNINGS AND INDICATORS

Hazard or condition	Chime or tone/remedy
External lamps remain on when the driver's door is opened.	A chime will sound until the lamps are switched off or driver's door is closed. The chime will not sound if the lighting control is in AUTO position.
Memory 1, 2 or 3 configuration saved.	A short tone as the memory selection is saved.
Airbag system failure.	A tone sequence is repeated five times. Seek qualified assistance as soon as possible.
Seat belt reminder.	A chime will sound until an unfastened seat belt is fastened. The warning will cease if all the front seats are occupied and the seat belts are buckled, the vehicle is brought to a halt, the ignition is turned off or more than approximately five minutes has elapsed with the vehicle in motion, the ignition on and an occupied seat belt unbuckled.
Electric parking brake (EPB).	If the EPB is applied while the vehicle is moving a continuous chime will sound; release the EPB. If there is a fault with the system which would prevent the application of the EPB, a brief sequence of chimes is initiated.
Adaptive Cruise Control (ACC) driver intervene and Forward Alert.	Multiple chime. Apply the brakes.
ACC low speed automatic switch off.	A chime will sound to indicate that the ACC system is no longer operating.
Speed is over 15 km/h (9 mph) above the set limit speed.	A short warning chime. Reduce speed.
Gear selector is not in Park with ignition off.	A chime will sound. Select Park.
Entry delay warning (European markets only).	Intermittent slow, low pitched chime. Disarm vehicle.
Convertible roof starting to open or close.	High-pitched single chime.
The Jaguar Smart Key cannot be detected.	A chime will sound. The remote handset should be inserted into the starter control unit.
The Jaguar Smart Key is to be removed from the starter control unit.	A chime will sound for 60 seconds if the Jaguar Smart Key is in the starter control unit and the driver's door is opened. The remote handset should be removed from the starter control unit.
DSC OFF	A chime will sound.

Information displays

GENERAL INFORMATION

The driver message and information centre display panel is situated within the instrument panel, between the tachometer and speedometer gauges.

The message and information centre is active as soon as a door is opened for access.

The primary function of the message centre is to inform the driver of the following:

- Warning messages
- Temporary alert messages
- Information messages.
- Turn-by-turn navigation information.

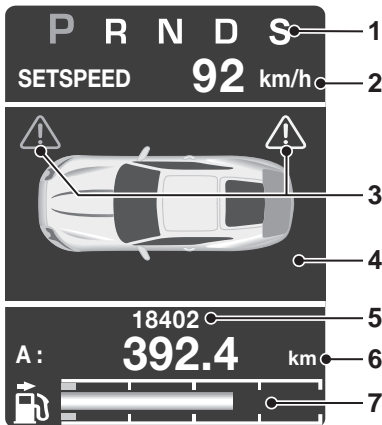

JAG1362

The message centre screen is divided into various zones displaying the following:

1. Gear selection, automatic or manual.
2. Speed control related information.
3. Priority warning indicators.

4. Warning messages (red or amber), if system faults are detected. Status messages are displayed to indicate changes in state of certain vehicle functions (e.g. navigation, telephone).

When there are no current warning messages, turn-by-turn navigation information is displayed, giving instructions for the next junction. This facility can be turned off via the touch-screen.

The clock can be shown when no other information is required to be displayed. See **CLOCK** (page 124).

5. Trip computer information, including total distance covered by the vehicle. See **TRIP COMPUTER** (page 99).
6. Set trip computer information display to **A**, **B** or **Auto** trip computer. See **TRIP COMPUTER** (page 99). When selected using the trip computer button, this area also shows the current electronic engine oil dipstick reading. See **ENGINE OIL CHECK** (page 183).
7. The fuel level gauge, which changes colour from blue to red when the fuel level drops to the reserve fuel level indicator. The small arrow on the top of the fuel pump symbol denotes which side of the vehicle the fuel filler cap is located.

Information displays

WARNING AND INFORMATION MESSAGES

WARNING



If a red warning indicator is displayed, stop the vehicle as soon as is safely possible. Do not ignore critical warning messages - doing so may result in serious damage to the vehicle.

Most warning messages, when displayed, have an associated warning indicator (red or amber), that will illuminate to indicate the message priority. Information messages will also be displayed.

If more than one message is active, each is displayed in turn for two seconds, in order of priority.

Messages take priority over the trip computer data and will be displayed when the ignition is on.

Note: *The message centre information messages and their meanings are detailed within the appropriate subject sections.*

Clearing messages from the display

It is possible to temporarily clear certain warning or information messages from the message centre.

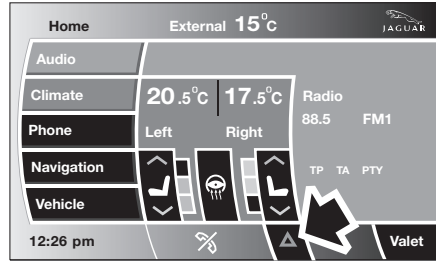

JAG1421

When a message is displayed in the message centre (e.g. **WASHER FLUID LOW**), a red warning triangle icon appears on the touch-screen, where shown.

Touch the icon to temporarily stop the currently displayed message from appearing. Once the message is removed, the colour of the warning icon in the message centre changes to white, as a reminder that an outstanding message exists.

Note: *Certain warnings, that are critical for the safe operation of the vehicle, cannot be cleared from the display.*

Note: *If multiple messages are displayed, this process can be repeated to remove all messages from the display.*

Removed messages will display again, whenever the ignition is switched on, until the fault is rectified (i.e. in this example, when the washer fluid is topped up).

Information displays

TRIP COMPUTER

The computer memory stores data for a journey, or series of journeys, until it is reset to zero.

The displayed information is for guidance only, as it can be affected by traffic, road and weather conditions.

Three independent memories are available; A, B and Auto. A and B memories can be set independently, while the Auto trip will reset after every ignition cycle, as the vehicle moves.

Full trip computer information for the trip memories can be displayed on the vehicle touch-screen located in the centre console, while current selected trip computer information is displayed on the instrument panel message centre.

To access the trip computer touch-screen settings:

- From the main Home menu, select **Vehicle**.
- Select **Trip computer**.
- Select requirements from the menu.

Trip computer message centre display

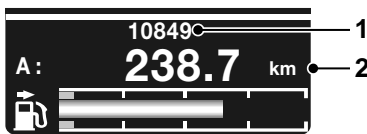

E91243

The odometer reading (vehicle total distance travelled - **1**) and trip distance (**2**) are displayed, as well as average fuel economy and average speed (if selected via the touch-screen). Also A, B or Auto will be displayed, depending on the current memory selected.

Odometer

The odometer shows the total vehicle distance travelled since the vehicle was new.

The odometer and trip distance reading is displayed in either miles or kilometres, depending on the units selected via the touch-screen. See **PERSONALISED SETTINGS** (page 103).

Changing the display

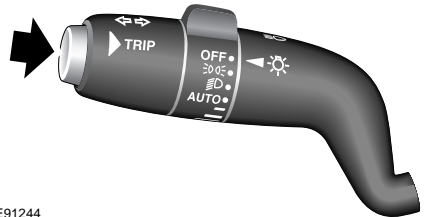

E91244

Press the **TRIP** button on the end of the left column stalk switch repeatedly to display the message centre data in the following order:

- Trip distance
- Average speed
- Average fuel consumption
- Range.
- Engine oil level.

Trip distance (A, B and Auto)

Distance travelled since the last memory reset. The maximum trip reading is 16 090 kilometres (9 999.9 miles). The computer will automatically reset to zero if this distance is exceeded.

Information displays

Average fuel consumption (A, B and Auto)

The average fuel consumption, litres per 100 kilometres (except Japan, kilometres per litre), miles per litre or miles per gallon (UK only), based on the accumulated distance travelled and the accumulated fuel used.

Range

This shows the predicted distance (miles or kilometres) that the vehicle should be able to travel on the remaining fuel, assuming average fuel economy and fuel consumption stay constant.

Average speed (A, B and Auto)

The average speed since the last press of the reset button.

ML-km (also Miles-litre)

The display of metric or imperial units is selected via the touch-screen. See **PERSONALISED SETTINGS** (page 103).

Display language

The display language is selected via the touch-screen. See **PERSONALISED SETTINGS** (page 103).

Reset

Resetting of the trip memories is carried out via the touch-screen.

Engine oil level

Shows the current engine oil level and any associated warnings or messages. See **ENGINE OIL CHECK** (page 183).

Service interval indicator

The service interval message will only be displayed when the vehicle has less than 3400 km (2000 miles) before the service is due.

When the ignition is switched on, and the vehicle has started its service countdown, **SERVICE REQ'D XXXX km (XXXX MLS)** is displayed for five seconds in the message centre with an Amber warning icon.

When the service distance has been reached, **SERVICE REQUIRED** is displayed for five seconds in the message centre, accompanied by a red warning icon.

The distance countdown reduces in increments of 50 km or 50 miles, depending on which display units have been selected.

The distance countdown is controlled by the engine management system and is automatically adjusted to allow for driving style and conditions. This gauges when the service becomes necessary.

CAUTION



If no service interval indicator is displayed during the vehicle service cycle, make sure that your vehicle is serviced in accordance with the intervals, as stated in the Service Portfolio.

Note: After the completion of each service, the Dealer/Authorised Repairer will reset the distance display to commence the countdown to the next service.

Information displays

TOUCH-SCREEN



JAG1363

Note: When the engine is stopped, for the touch-screen to remain active, press the engine START/STOP button again without pressing the brake pedal (ignition system on).

- 1. Touch-screen:** When initially activated, the touch-screen will display the main Home menu. From this menu, all touch-screen facilities and operations are initiated by touching the relevant buttons and icons.
- 2. Touch-screen on/off:** Press once to turn the screen on, press again to revert to screen-saver mode. A further press will turn off the touch-screen.
- 3. Home menu:** Press to return to the main Home menu from all facilities.

System facilities

There are five major systems controlled via the touch-screen, with their individual levels of operation and settings. They are as follows:

- Audio:** Radio display AM/FM, CD or portable audio.
- Climate:** Air conditioning, distribution, Seats, heated steering wheel, automatic air recirculation.
- Phone:** Digit dialler, phone book, last ten calls (made, received, missed).

- Navigation:** Destination, stored locations, navigation setup, route options.
- Vehicle:** Security, parking, valet mode, trip computer, clock, brightness, contrast and system, vehicle and display settings.

Touch-screen use

WARNING



In the interest of road safety, only operate, adjust or view the system when it is safe to do so.

CAUTION



Always run the engine during prolonged use of the touch-screen. Failure to do so may discharge the vehicle battery, preventing the engine from starting.

When the engine START/STOP button is pressed, the touch-screen can be activated by the on/off switch on the touch-screen console.

The buttons surrounding the touch-screen display are referred to as **hard buttons** and should be pressed firmly. The touch-screen buttons are referred to as **soft buttons** or **icons** and only require short, light pressure to function. Do not use excessive pressure.

Information displays

When operating touch-screen buttons, always extend the tip of one finger, and withhold the thumb and remaining fingers from the screen. Touching the screen with more than one finger at a time, may cause false inputs.





Throughout the handbook, the expression **Select an item** (or similar wording) means **touch the on-screen button** to select or alter the required item.





The handbook shows the on-screen menus, explains how to operate the controls and illustrates how to select or alter settings and requirements. After becoming familiar with the controls, follow the on-screen menus and prompts, to operate the system as required.

Where it is thought that guidance through the touch-screen menus is necessary, additional information has been given within that section or subject.

Touch-screen display icons

Touch-screen display icons are as follows (they may not all be displayed at the same time):

-  Return to the previous screen displayed.
-  Warning triangle icon, indicating a warning pop-up message. Touch the pop-up to cancel. The warning message will be displayed in the message centre.
-  Telephone: start call/send button.
-  Telephone: end call.
-  Page up or increase setting to required value.

-  Page down or decrease setting to required value.
-  Direct access to the valet mode setting screen.
-  Telephone signal strength indicator.
-  Telephone battery charge indicator.
-  No phone connected.

Touch-screen care

CAUTION

-  Care must be taken to avoid spilling or splashing fluids onto the touch-screen.

Do not use any abrasive cleaners to clean your touch-screen. For approved screen cleaners, you should contact your Jaguar Dealer/Authorised Repairer.

The touch-screen inner bezel must be kept clean to maintain optimum performance. Finger marks and attracted dust should be regularly removed using a soft cloth and a Jaguar approved cleaning agent.

Where possible, avoid exposing the touch-screen to direct sunlight for long periods.

Information displays

PERSONALISED SETTINGS

General information

The touch-screen provides touch-control of the vehicle Audio, Climate, Phone, Navigation and Vehicle systems, as fitted.

Note: When the engine is stopped, the touch-screen reverts to stand-by mode. To activate the touch-screen press the engine START/STOP button again.

Home menu

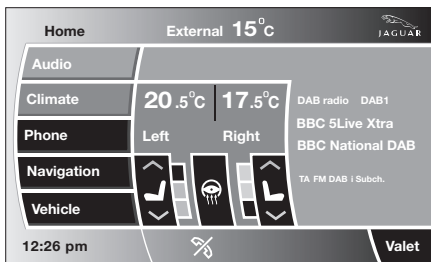

JAG1415

When initially activated, the touch-screen will display the main Home menu. The Home menu may also be displayed at any time by pressing the Home button on the screen surround.

Screen settings: The touch-screen brightness and contrast can be set to individual requirements, including dimming for night driving. This is accessed via the **Vehicle** menu. Select **Cont./Bright.**

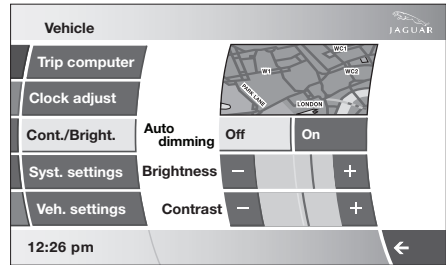

JAG1416

Auto dimming: Select **Auto dimming On**. Brightness and contrast are automatically adjusted by the ambient light level. As the light level decreases, the touch-screen brightness will decrease, until the full night screen level of brightness is initiated.

Further adjustment of the touch-screen brightness can be achieved by using the **+** or **-** buttons on the **Cont./Bright.** menu, or by adjustment of the instrument panel dimmer switch. See **INSTRUMENT LIGHTING DIMMER** (page 123).

Pop-up messages

The operation of certain functions will cause a small message (pop-up) to appear overlaying the touch-screen display.

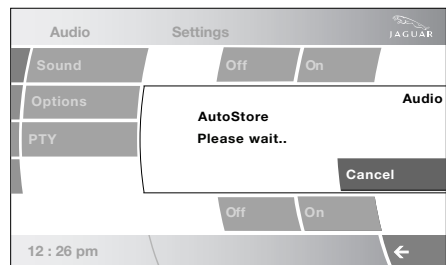

E91330

The pop-up is mainly for information, and will disappear automatically after a few seconds or can be dismissed manually, by touching the pop-up screen area.

Information displays

If any action or adjustment is required, the message will clearly indicate what is required and which button to touch.

Touch-screen systems

There are five major systems controlled via the touch-screen with their individual levels of operation and settings. They are as follows:

- **Audio**
- **Climate**
- **Phone**
- **Navigation**
- **Vehicle.**

Audio system

The vehicle Audio system interacts with Navigation, In-car Telephone and Climate control systems.

The Audio system can be controlled from the switches on the touch-screen console, the touch-screen buttons and from the multi-function controls on the left-hand side of the steering wheel. See **AUDIO CONTROL** (page 246).

Automatic climate control

The automatic climate control system can be controlled from the touch-screen buttons. See **AUTOMATIC CLIMATE CONTROL** (page 107).

Phone

The communications system is composed of the following facilities:

- Phone
- Digit dialler
- Phone book
- Last ten calls made, received, missed.

The telephone system is controlled from the touch-screen and the multi-function controls on the left-hand side of the steering wheel. See **AUDIO CONTROL** (page 64).

Navigation system

Detailed information on the operation of the navigation system is given later on in this handbook. See **Navigation system** (page 299).

Vehicle system

The following system functions are set using the touch-screen:

- Trip computer
- Clock adjust
- Contrast and brightness
- System settings
- Vehicle settings.

Languages and distance units

The screen text and distance units, are available in various languages and either Imperial or Metric units.

The required languages and units are accessed by selecting **Vehicle** on the main Home menu, then selecting:

- **Trip computer**
- **Unit change**
- **Preferences** and then selecting from the menu.

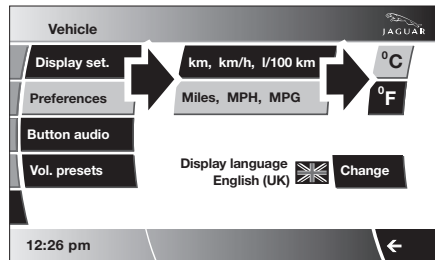

JAG1417

To change the units: The unit choices are selected by touching the relevant button (either **km, km/h, l/100 km**, or **Miles, MPH, MPG**).

Temperature display is selected by touching either **°C** or **°F**.

Information displays

Note: Celsius or Fahrenheit may be selected independently of metric or Imperial units.

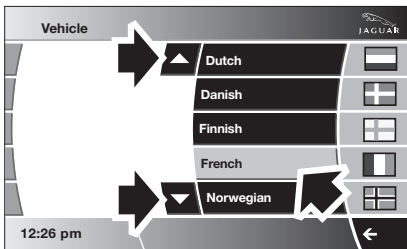
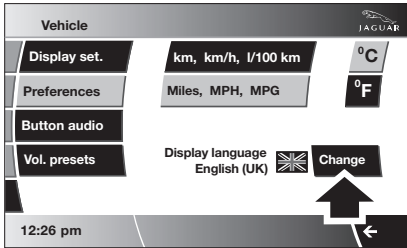

JAG1418

To change the language: The language choices are displayed as a list. Scroll up or down through the list using the up or down arrows.

Note: The navigation system is not affected by the language change. To change the navigation system language display, refer to the Navigation System Handbook.

Timeout to home menu

The Timeout to home screen (return to display the Home menu) can be adjusted.

From the Home menu, select **Vehicle**.

1. Select **Syst. settings**.

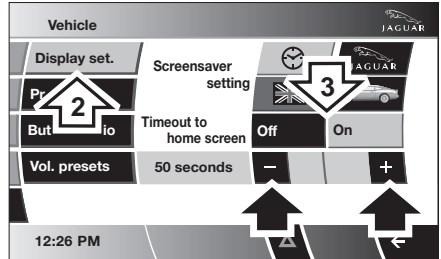

JAG1419

2. Select **Display set**.
3. Select **Timeout to home screen** (either **On** or **Off**)

Using the adjustment bar, the timeout can be adjusted from ten seconds to five minutes.

Note: An initial default setting of one minute is set if no time adjustment is made.

Climate control

PRINCIPLE OF OPERATION

The climate control panel is located in the centre console. There are two control facilities:

- A dedicated control panel located below the Audio unit panel for operation of the basic features.
- A touch control and display unit for additional functions and personal settings.

The climate control system features automatic temperature and air distribution control, which is programmed to maintain optimum levels of comfort within the vehicle in all but the most severe conditions.

While the controls can be adjusted manually to satisfy individual requirements, allowing the system to function automatically (in AUTO mode) is the simplest method of operation and is preferable in most operating conditions.



In AUTO mode, an air recirculation sensor detects pollutants and selects air recirculation

when the level of pollution outside the vehicle reaches a certain level.

The sensor response level can be adjusted on the touch-screen.

Once the level of pollutants decreases, air recirculation will switch off.

To set the automatic air recirculation sensitivity level of the pollution sensor:

- From the Climate menu on the touch-screen, select **Settings**.
- Adjust the automatic air recirculation sensitivity setting as required by selecting the + or - buttons.

Use of air conditioning

Note: To prevent humidity build-up inside the vehicle and possible screen misting, avoid driving with the air conditioning system off or in manual air recirculation for prolonged periods.

Air conditioning is an integral part of the climate control system, providing cooled and dehumidified air for occupant comfort. The dry airflow is also effective in preventing misting of the windows.

While the air conditioner can be manually switched off, it is recommended that it is used in all climatic conditions throughout the year, preferably in AUTO mode.

Close all windows and the convertible top when the air conditioning is on, to ensure satisfactory operation.

- If the air conditioning system is not used frequently, it should be run briefly at least once each week, with a cold setting. This will prevent the seals from drying out with subsequent refrigerant leaks.
- Surplus water produced by the dehumidifying process is expelled from the system via drain tubes beneath the vehicle. This may result in a small pool of water forming on the road when the vehicle is stationary and is not a cause for concern.

Climate control

AIR VENTS

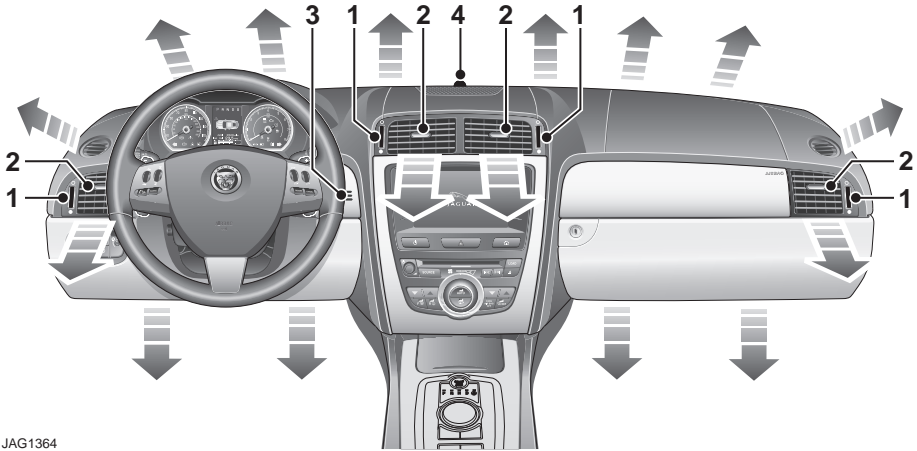

JAG1364

The air vents provide fresh or heated air to the interior of the vehicle. Ensure that the air intake grille at the base of the windscreen is kept clear of any obstruction.

Adjust airflow and direction with the thumb-wheel controls (1) and direction vanes (2).

AUTOMATIC CLIMATE CONTROL

Automatic climate control provides efficient regulation of the vehicle environment without constant adjustments from the occupant.

Sensors inside the vehicle monitor temperature, humidity (3) and direct sunlight (4). Do not obstruct these openings. In response to sensor indications, the electronic control system automatically adjusts the heat input, blower speed, air intake and airflow distribution to maintain the selected temperature(s) and reduce misting.

Automatic operation provides optimum comfort under most driving conditions.

AUTO can be overridden at any time.

It is recommended that automatic control (AUTO) is selected as the normal operating mode.

Climate control

Control panel



JAG1365

1. Rear screen heater.
2. Front screen heater.
3. Temperature decrease, left-hand zone.
4. Temperature increase, left-hand zone.
5. Air recirculation and fresh air.
6. AUTO climate control knob.
7. Blower speed rotary control.
8. Temperature decrease, right-hand zone.
9. Temperature increase, right-hand zone.
10. Windscreen defrost and demist.
11. Climate control main touch-screen menu.

Panel illumination

The illumination level is adjusted by the common instrument panel dimmer control. See **INSTRUMENT LIGHTING DIMMER** (page 123).

To switch the climate control on

With the ignition on, press the **AUTO** rotary control knob on the control panel. The system will switch on in the AUTO operating mode. The control knob indicator will illuminate.

Note: It is advisable to allow the system to stabilise before making large changes to the temperature settings, particularly at the start of a journey.

To switch the climate control off

The system can only be turned off using the options on the Climate touch-screen menu.

Climate control

AUTO mode

Automatic operation provides a controlled environment over a temperature range of 16°C to 28°C (59°F to 83°F) and should be regarded as the normal operating mode.



To select automatic climate control press the AUTO button, the control knob indicator

illuminates to confirm selection.

Select the required temperature.

Front and rear screen heating and timed air recirculation may be selected in AUTO mode. Selecting any other manual control will cancel AUTO operation (the control knob indicator will extinguish).

Temperature selection



Separate controls allow the driver and passenger zone temperatures to be

independently adjusted. Press the red buttons to increase temperature and the blue buttons to decrease temperature.

Both driver and passenger temperatures are displayed on the touch-screen.

Pressing the driver's buttons to select the maximum or minimum temperature settings causes the display to change to **HI** or **LO** respectively and cancel AUTO mode.

To quickly jump from **HI** or **LO** to a convenient mid-range temperature of 22°C (72°F), press and hold **AUTO** for a few seconds.

Air recirculation

CAUTION



Prolonged operation with recirculation selected and setting the automatic air recirculation sensor to a needlessly high level in cold and damp conditions, could result in interior screen misting.



Press the recirculation button to select air recirculation. Selection is indicated by the

screen symbol and the button indicator illuminating.

Press again or press **AUTO** to deselect.

When selected, the air is recirculated inside the vehicle. This helps to maintain a high or low temperature, and is useful for preventing fumes from entering the vehicle.

Recirculation may also be selected in AUTO mode, if the climate control system detects high levels of pollution in the atmosphere outside the vehicle (if a smog sensor is fitted). Manual operation of the recirculation control will override the automatic setting. This facility can be switched off through the Settings menu on the touch-screen.

Note: Prolonged use at low temperatures may cause the windows to mist.

Note: When air recirculation is selected, the sound of the airflow will change, this is normal.

Climate control

Windscreen defrost and demist



To remove frost or heavy misting from the windscreen, press the DEF button.

- The blower switches on at a high speed but it can be adjusted manually if required.
- Air conditioning switches on automatically (to dehumidify the air) and cannot be deselected.
- Recirculation is cancelled and cannot be selected.
- The front screen heater and the rear screen heater and door mirror heaters switch on automatically, provided the engine is running.
- The button indicator illuminates.

Press again or press **AUTO** to deselect.

Heated screens



The front (F) and rear (R or REAR) screen heaters may be switched on and off in any mode,

including system off. They will only operate when the engine is running.

The front screen heater switches off automatically after 6.5 minutes. The rear screen and door mirror heaters switch off automatically after 21 minutes.

The screen heaters can be manually deselected using the buttons.

In cold ambient conditions, at the start of a journey, the front and rear screen heaters will switch on automatically for the timed period. The rear heated screen will come on at temperatures below -1°C (30°F) and the front screen will come on below 5°C (41°F).

Air conditioning



Press the AUTO rotary control knob to turn the air conditioning on.

The air conditioning system is controlled automatically in AUTO mode to maintain the desired temperature and humidity (even if higher temperature settings are selected).

The air conditioning system is also switched on automatically in defrost mode (DEF) in order to dehumidify the air.

Blower speed



Set the blower speed by adjusting the AUTO rotary control knob.

When operating in AUTO mode, blower speed is controlled

automatically and **AUTO** is displayed on the touch-screen. Any adjustment of the knob will cancel AUTO mode.

Note: In AUTO mode, the blower only operates at low speed, if heating is required, until the engine is warm.

Heated/climate seats and steering wheel

The heated seats, climate seats and steering wheel can be controlled only from the options on the touch-screen. See **HEATED SEATS** (page 37). See **CLIMATE SEATS** (page 37). See **HEATED STEERING WHEEL** (page 63).

Climate control

Touch-screen operation

The heated seats, climate seats and steering wheel can be controlled from the touch-screen Home menu. Other elements of climate control can be adjusted using the Climate menu, accessed by selecting **Climate** on the Home menu.

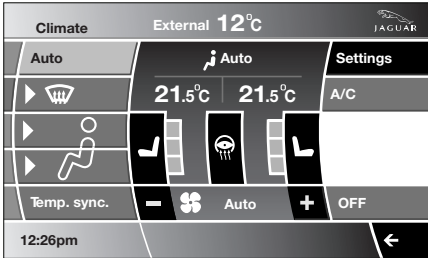

E95094

The Climate main menu is displayed, from which the climate settings can be adjusted.

Climate control display icons



Auto climate control on.



Distribution to windscreen.



Distribution to face.



Distribution to feet.

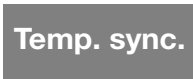

Synchronizes the driver and passenger climate control zones.



Blower speed control decrease and increase.

Settings

Access to the Settings control touch-screen to adjust personal climate zone settings, also access to the automatic air recirculation sensor control setting.

A/C

Air conditioning on/off. When the air conditioning is switched off, economy mode is selected automatically. Economy mode turns off the air conditioning compressor and reduces power consumed by the climate control system. This will reduce air conditioning performance. Prolonged use of economy mode, may cause the windows to mist.

OFF

Climate control on/off button.

External temperature

The external temperature is displayed at the top of the climate touch-screen.

Climate control

Smog/pollution filter

The smog filter operates in conjunction with the air recirculation feature, to reduce pollutants entering the vehicle.

When pollution is detected by the smog sensor, air recirculation is selected automatically, to help prevent pollution entering the vehicle.

The sensitivity of the smog sensor can be adjusted for personal preference or the sensor can be switched off entirely, as follows:

1. Select **Settings** from the Climate menu.

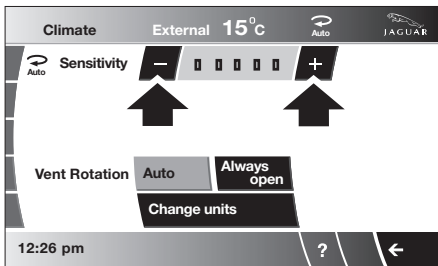

JAG0914

2. Touch the + or - buttons to increase or decrease the sensitivity of the smog sensor.

There are five sensitivity settings, indicated by the five bars between the + and - buttons. To switch the smog filter off, touch the - button until none of the five bars are illuminated.

 This icon appears at the top of the touch-screen when the smog filter is on. When the smog sensor is switched off, this icon will not be displayed.

Convertible top

OPENING THE CONVERTIBLE TOP

WARNINGS



Before opening or closing the convertible top, ensure that all occupants have moved their hands, fingers, hair, etc. clear of moving parts.



Do not place items on the tonneau panel or over the Rollover Protection Device covers.

CAUTIONS



The convertible top will not operate unless the luggage separator is correctly located in the deployed position in the luggage compartment and that the luggage compartment lid is firmly closed.



Do not at any time during the opening or closing of the convertible top press the engine START/STOP button as all movement will cease and the convertible top will have to be manually re-set.



Check that there is nothing in the rear area which could interfere with the top when folding down, e.g. ensure that the battery cover trim is fitted and secure.



Do not attempt to operate the convertible top at temperatures below -15°C (5°F). This may cause damage to the fabric.



If the convertible top is operated above 24 km/h (15 mph), there is a risk of damage to the convertible top.



Do not attempt to open the convertible top manually, as damage to the linkage mechanism may occur.

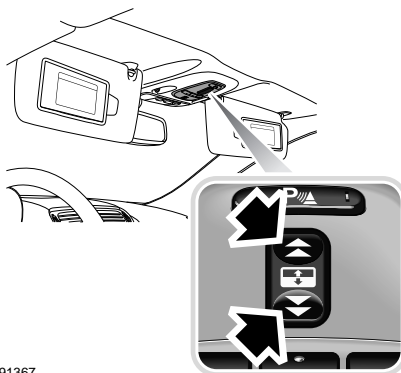

E91367

The power operated convertible top and rear quarter windows, are controlled by the switch located on the overhead console. See **ELECTRIC WINDOWS** (page 83). The ignition system must be on. The top will latch and unlatch automatically.

The top can be operated at speeds below 24 km/h (15 mph). However, for safety it should not be opened or closed when the vehicle is being driven.

1. Ensure that the ignition is on.
2. Ensure that the luggage separator in the luggage compartment is in the fully deployed position. If it is not positioned correctly the proximity switches will not operate and the convertible top will not open.



E91368

3. Press and hold the rear of the overhead console switch (do not release the switch until the top is fully open).

Convertible top

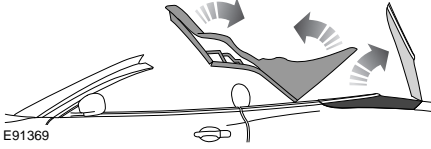

4. The rear quarter windows open, an audible warning sounds and the top unlatches and starts to move. The tonneau closing panel opens (the front windows will fully open. The door window switch will require to be pressed to close the windows).

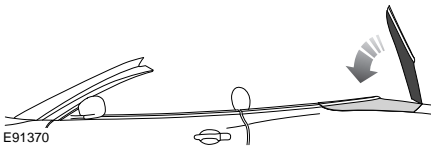

5. When the top is fully open, the audible warning sounds again. The tonneau closing panel is fully automated and encloses the convertible top in the stowed position.
6. Release the overhead console switch.

Note: *If at any period during the convertible top opening sequence the switch is released, all movement of the convertible top will cease.*

Convertible top manual re-set

WARNING



It is advisable that two persons carry out this procedure, so that the convertible top and tonneau cover are fully supported when required; although it is possible that this procedure may be carried out by one person with care.

To manually re-set the convertible top:

Ensure that the engine is not running and that the ignition is off.

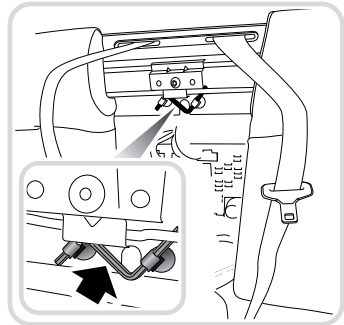
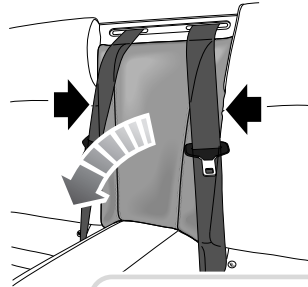

Remove the Allen key from its stowed position, behind the rear seat centre section, by grasping the sides of the section, as shown, and pulling sharply.

Convertible top

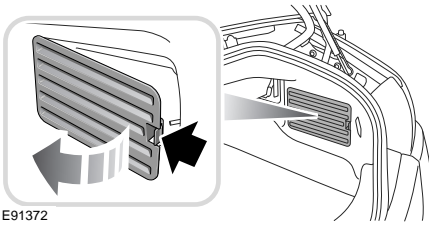

From inside the luggage compartment, remove the vent screen to access the convertible top operating pump.

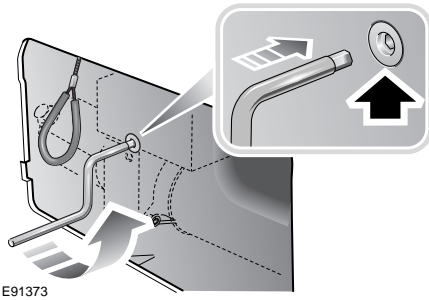

Insert the Allen key into the pump and rotate counterclockwise (approximately one turn).

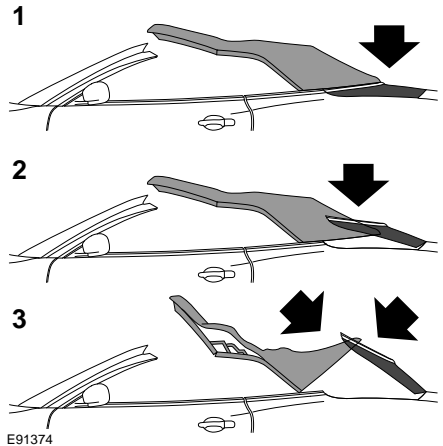

The convertible top and tonneau cover movement can cease in any of the positions **1**, **2** or **3**, as shown.

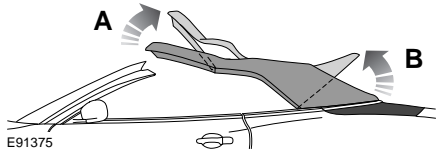

If the movement ceases in position **1**, release the tension in the convertible top cover and tension bow (rear of convertible top) by lifting the front of the convertible top and pulling rearwards **A**.

Lift the tension bow upwards **B**, and forwards to clear the tonneau cover.

Convertible top

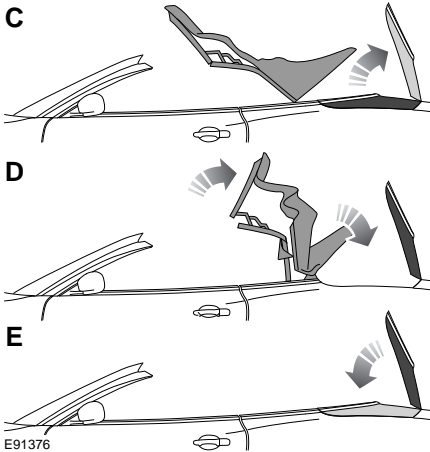

Lift the tonneau cover fully and support **(C)**. Pull the convertible top rearwards and downwards **(D)** so that it is fully stowed.

Rest the tonneau cover in the closed position **(E)**.

If the movement ceases in either positions **2** or **3**, lift the tonneau cover fully upright and support **(C)**, pull the front of the convertible top rearwards and downwards so that it is fully stowed **(D)**.

Rest the tonneau cover in the closed position **(E)**.

All positions: Once the convertible top has been reset, turn the Allen key clockwise approximately one turn and return it to its stowed position, refit the rear seat centre section, luggage compartment vent screen and close the luggage compartment lid.

Switch on the ignition and start the engine. Press and hold the front of the convertible top switch until the convertible top is closed and fully latched.

If the convertible top requires to be open, press and hold the rear of the switch.

Preparation for winter

Before the onset of winter, it is advisable to coat the convertible top seals and respective body seals with a compound, such as Carbaflo KSP 105, to aid operation in freezing conditions.

This action will need to be repeated at the start of each winter to maintain protection.

Care must be taken so that the compound does not come into contact with the convertible top material. For further advice you should contact your Jaguar Dealer/Authorised Repairer.

Luggage separator

CAUTION



Luggage items should not be placed forward of or on top of the luggage separator, as this could cause damage.

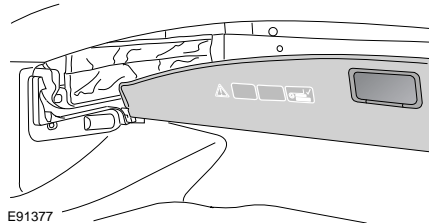

A luggage separator is located in the luggage compartment, to prevent items from moving into the area where the convertible top is stowed.

When the convertible top is closed, the normal position for the luggage separator is in the retracted position, with the partition positioned vertically.

Convertible top

To deploy the luggage separator

CAUTION

⚠ Do not place large objects underneath the luggage separator partition when deployed as damage to the convertible top may occur.

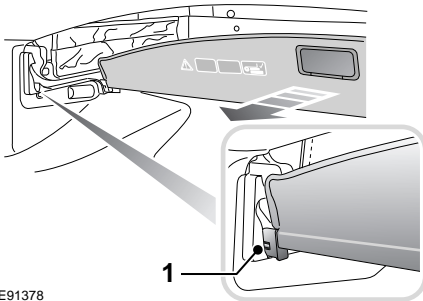

E91378

Pull the handle on the luggage separator towards you. There is a lug on either side of the luggage separator: slide the lugs into the sliders on either side of the luggage compartment. The luggage separator will positively locate in the vertical position. A proximity switch (1) is located in the separator assembly, so that the convertible top will not open and retract until the separator is in the fully deployed position.

When selected, if the convertible top does not open, check that the positioning of the luggage separator is correct and ensure that the luggage compartment lid is firmly closed.

To remove the luggage separator

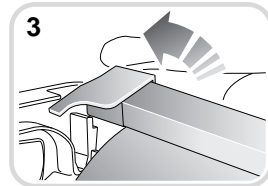
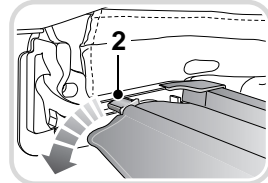
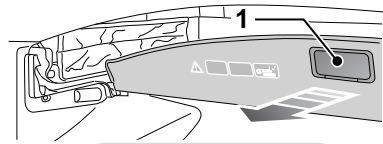

E91379

With the luggage separator in the stowed position, pull the handle towards you (1) and disengage the lugs from the sliders (2).

Holding the centre of the main body of the luggage separator, rotate upwards (3), disengaging the main body of the luggage separator from the support brackets. Remove the luggage separator and retract the withdrawn partition section of the luggage separator into the main body.

Convertible top

To install the luggage separator

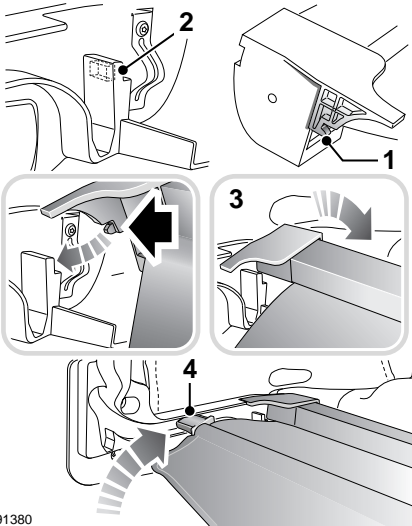

E91380

With the partition slightly extracted, position the luggage separator up to the support brackets, with the front edge raised. Ensuring that for both sides, the catch (1) will engage in the locating slot (2), rotate the main body of the luggage separator (3), so that it sits down into the support brackets. Fit the partition lugs into the sliders (4) and retract the luggage separator partition into the normal stowage position.

CLOSING THE CONVERTIBLE TOP

1. Ensure that the ignition is on.
2. Press and hold the front of the overhead console switch. See **OPENING THE CONVERTIBLE TOP** (page 113). Do not release the switch until the convertible top is fully closed and latched and, if required, the rear quarter windows and front door windows are fully closed.
3. If the front windows are in any other position than fully down, they will retract to the fully down position on pressing the closure switch. As the convertible top starts to move, the audible warning will sound.
4. When the top is fully closed and latched, the audible warning sounds again and the rear quarter windows will close, followed by the front door windows returning to the fully closed position.

Note: *If at any period during the convertible top closure sequence, the switch is released, all movement of the convertible top will cease.*

Convertible top

Manual closure of the convertible top

If necessary, the convertible top can be closed manually, as follows:

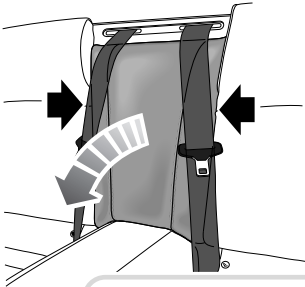

E91371

1. Grasp the sides of the section, as shown, and pull sharply. Remove the Allen key from its stowed position.

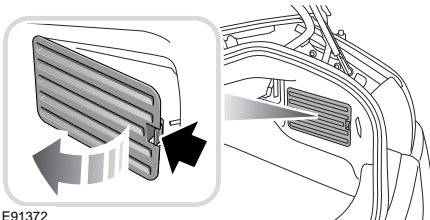

E91372

2. From inside the luggage compartment, remove the vent screen to access the operating pump.

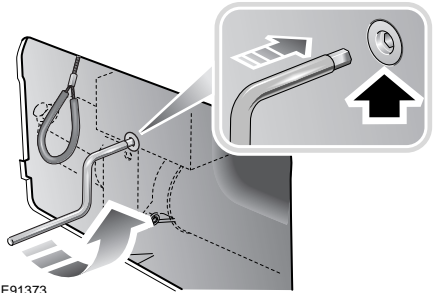

E91373

3. Insert the Allen key into the pump and rotate counterclockwise (approximately one turn).

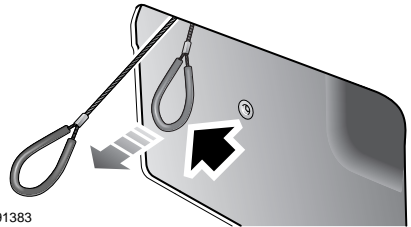

E91383

4. Pull the tonneau release cable, until fully extended. Close the luggage compartment lid.

Convertible top

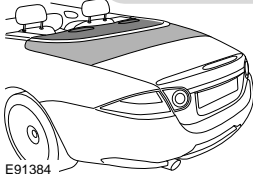
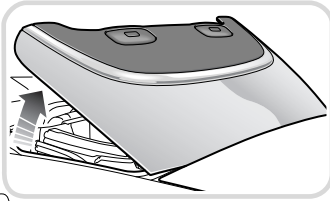

E91384

5. Fully open the tonneau panel. It will self-support when fully opened.

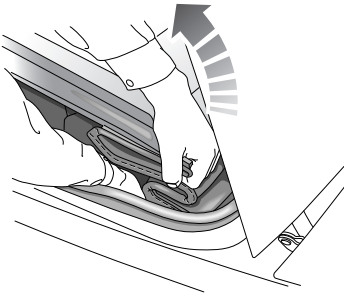

E91385

6. From the left-hand side of the vehicle, place your right hand down the side of the folded convertible top. Ensure that the bottom of the convertible top, which includes the tension bow, is securely held. Securely hold the convertible top header assembly with your left hand. With both hands pull the whole of the convertible top up and forward.

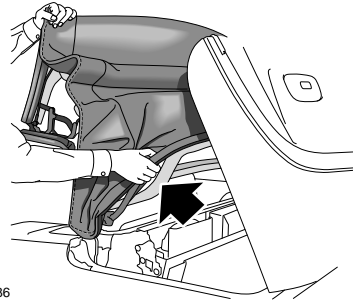

E91386

7. Ensure that the tension bow is fully raised.

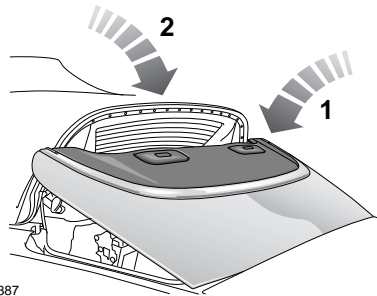

E91387

8. Supporting the tension bow, lower the tonneau panel (1). Then lower the tension bow (2) onto the tonneau panel.

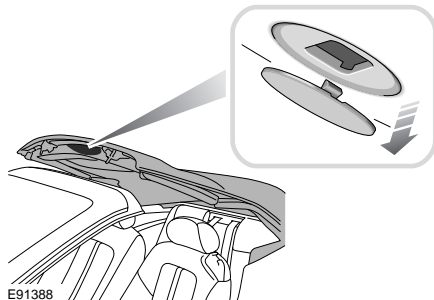

E91388

9. Remove the plug from the convertible top header trim.

Convertible top

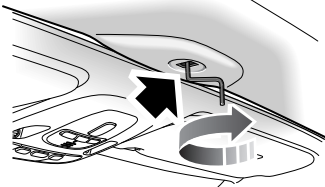
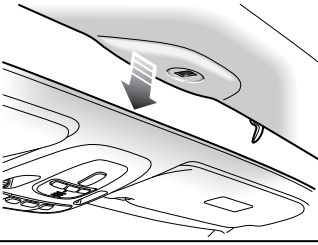

E91389

10. Support the front header. Insert the Allen key into the header panel key slot and turn clockwise until the top is securely latched and resistance is felt.
11. Return the Allen key to its stowed position, refit the rear seat centre section, luggage compartment vent screen and the plug into the convertible top header trim.

Message centre information displays

Message	Priority indicator	Meaning
HOOD NOT LATCHED	Red	The convertible roof is not latched, check for security.
HOOD OUT OF POSITION	Amber	The convertible roof is not positioned correctly. Open or close the convertible roof again and check for correct positioning.
LUGGAGE COVER OUT OF POSITION	Amber	The luggage separator is out of position and should be checked. See OPENING THE CONVERTIBLE TOP (page 113).

Convenience features

MEMORY FUNCTION

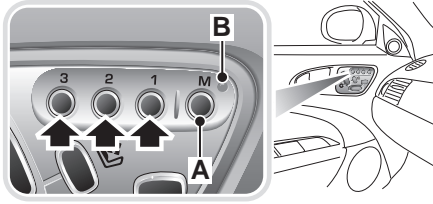

JAG1366

This facility enables the position of the driver's seat, steering column and exterior rear-view mirrors to be memorised and recalled. Three different position sets can be entered into the memory.

Setting a driving position

To store a driving position in the memory:

1. Adjust the seat, steering column and exterior rear-view mirrors to the desired positions.
2. In the door switch pack, push the **M** memory button (**A**) - the red indicator (**B**) will illuminate for a five second period.
3. While the red indicator is illuminated, press one of the memory preset buttons (**1**, **2** or **3**) to memorise. The indicator will extinguish and a chime will indicate that the setting procedure is complete. Additionally, if the ignition is on, the message centre will display a message that the settings have been saved.

To replace a memorised position with a new position

Adjust the seat to the desired position, perform steps 2 and 3 above. The previous memory will be erased and the new position will be set.

Recalling a memorised position from the door switchpack

Press and hold the appropriate memory preset button (**1**, **2** or **3**). The button has to remain pressed until the recall is complete. If the button is released before total recall is completed, all movement will cease.

Memory system operating tips

- When making adjustments to a set driving position, reset the new position using the same memory button.
- Ensure that the seat has completed moving into the required memory position, before shifting the gear selector from the **P** (Park) position.

Passenger seat memory setting

The passenger door has a seat memory switch pack similar to that on the driver's door.

The passenger seat can be set to three memory positions by using the memory preset buttons **1**, **2** and **3**.

The procedure for the setting and the recalling of the passenger seat memory is the same as for the driver's seat.

However, there are no acceptance messages or a completed procedure chime.

Convenience features

INSTRUMENT LIGHTING DIMMER



The instruments, switch packs and touch-screen, will be illuminated when the exterior lamps are switched on.

1. Push and release the knob to extend it for ease of operation.
2. Rotate the knob to adjust the illumination.
3. Push the knob again to return it to the stowed position.

SUN VISORS

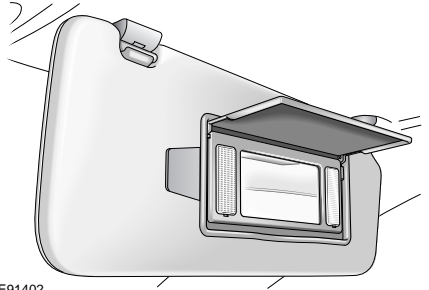

Adjustable sun visors can be swung downwards or unclipped and swung sideways to reduce sun glare.

The sun visors are fitted with a ticket holder and illuminated vanity mirrors, behind a hinged flap. The light comes on when the flap is lifted.

Convenience features

CLOCK

The clock time can be adjusted via the Home menu by selecting **Vehicle**.

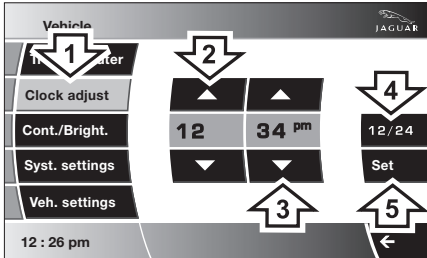

JAG1414

1. Select **Clock adjust**.
- 2 and 3. Touch the appropriate **up** or **down** arrow buttons to adjust the hours and minutes.
4. Toggles between 12 and 24 hour clock display. On the 12 hour display, **am** or **pm** is displayed as appropriate.
5. The displayed clock time in the bottom left-hand corner, will not change to the new time until **Set** is selected.

If **Set** is not selected, the altered time will be lost on exiting from the screen.

To set the clock as a screen saver

From the main Home menu, select **Vehicle**.

1. Select **Syst. settings**.
2. Select **Display set**.
3. Touch the clock symbol. The clock will now appear as the screensaver.

Note: To select an alternative screensaver from the four available, select the appropriate icon.

CIGAR LIGHTER

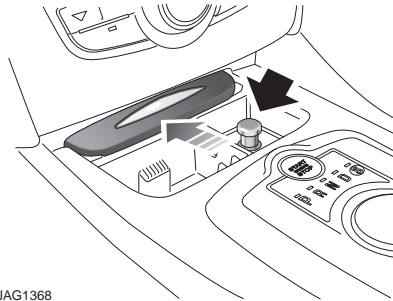

JAG1368

To gain access to the cigar lighter and ashtray, push the bottom edge of the lid.

To operate the cigar lighter, the ignition must be on. Press the lighter in and wait until the element has heated, it will then pop-up.

Note: Never hold the lighter knob down. Do not attempt to remove particles from the heating element as it is self-cleaning. The cigar lighter is designed to be used just to heat the lighter element and not for providing a power source for accessories.

The cigar lighter is replaced by a 12 volt accessory socket on certain models.

ASHTRAY

WARNING



Do not use the ashtray for disposing of waste paper or other combustible items.

To empty the ashtray, lift out vertically and remove. After emptying, push the ashtray into the opening until it snaps back into place.

Passenger door ashtray

To remove the passenger door ashtray bin, lift it out vertically.

Convenience features

AUXILIARY POWER SOCKET

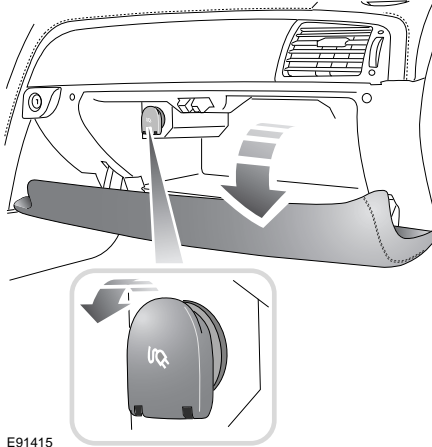

E91415

An electrical accessory socket is located inside the glove compartment. This 12 volt socket should only be used for the temporary connection of electrical items, such as a vacuum cleaner or cool box.

CAUTIONS

! Only Jaguar approved accessories should be plugged into the power sockets. Using any other equipment may damage the vehicle's electrical system. If you are in any doubt contact a Jaguar Dealer/ Authorised Repairer.

! The engine should be running when using accessories for long periods. Failure to do so can discharge the battery.

CUP HOLDERS

WARNINGS

! The driver should not drink or use the cup holder whilst driving.

! The cup holder should be kept closed when not in use.

! Do not place anything other than suitable drinks containers in the cup holder. Such items may be thrown about in the compartment in the event of an accident or emergency manoeuvre, which may cause injuries to the occupants.

! Do not carry open-top drink containers in the cup holders while the vehicle is in motion: a spilled hot drink could cause personal injury, and may damage upholstery, carpeting and electrical components.

! Use only for soft drinks containers. Do not use to hold cups made of glass, china or hard plastic, as these may cause injury in the event of an accident or emergency manoeuvre. Unopened, sealed containers (drinks cans, for example) are hard objects and may also cause injury.

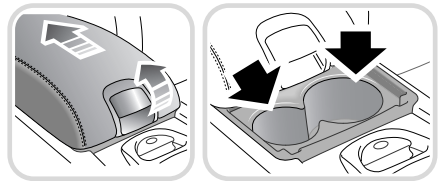

E91410

To access the two cup holders, pull the catch on the centre cubby box lid upwards and slide the lid/armrest rearwards.

Convenience features

STORAGE COMPARTMENTS

WARNING



Ensure that any items stored in the vehicle are secure and cannot move.

If the vehicle is involved in an accident, or subject to sudden braking or direction change, loose items can cause serious injury.

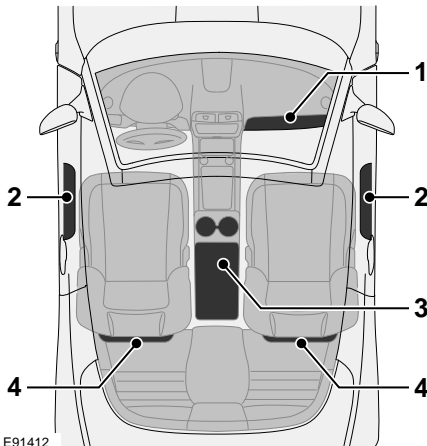

E91412

1. Glove box.
2. Door stowage compartments.
3. Centre cubby box.
4. Seat map pockets.

Glove box

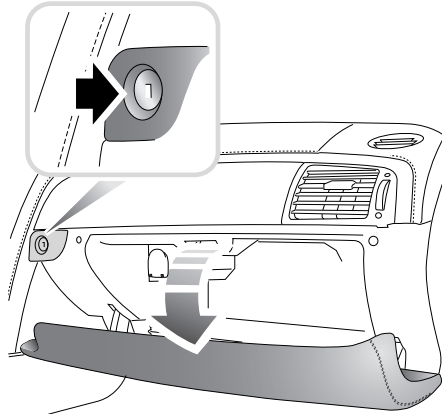

E91413

To open the glove box, press the release button and allow the lid to drop down. The glove box will be illuminated when open.

If the glove box is left open, the light will extinguish after approximately 40 minutes.

The glove compartment can be locked using the key blade and secured for valet mode. See **USING THE EMERGENCY KEY BLADE** (page 24).

Convenience features

CENTRE CUBBY BOX

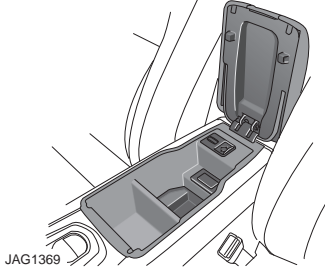
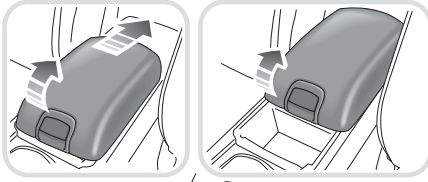

The sliding armrest is hinged at the rear and has a release button located on the front of the armrest.

Pull the chromed button upwards to raise the armrest and gain access to the cubby box. As the armrest is lifted it slides back under its own weight allowing full access to the cubby box.

PORTABLE AUDIO INTERFACE

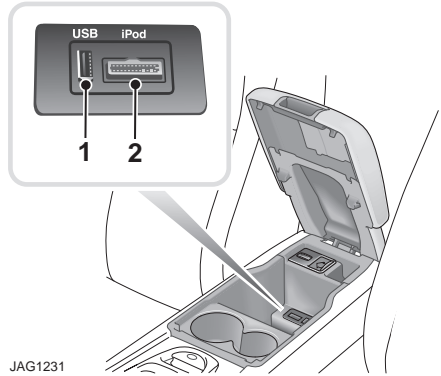

JAG1231

1. USB connector port.
2. iPod input port.

The interface sockets are located in the cubby box and can be used to integrate personal media devices with the vehicle's audio system. See **PORTABLE AUDIO** (page 277).

Convenience features

GARAGE DOOR TRANSCIVER

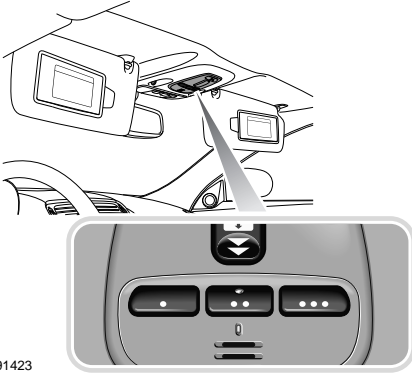

E91423

The door transceiver is located in the roof console. It can be programmed to transmit the radio frequencies of up to three different transmitters which can be used to activate garage doors, entry gates, home lighting, security systems or other radio frequency operated devices.

Although this section mainly describes the procedures for a garage door opener, it equally applies to the previously mentioned applications.

In some countries this feature is also known as the HomeLink® Universal Transceiver.

For further information, see **Information and Assistance** later in this section.

WARNINGS



Do not use the transceiver with any garage door opener that lacks the safety stop and reverse feature as required by safety standards. Using a garage door opener without these features increases risk of serious injury or death.

WARNINGS



When programming the transceiver to a garage door opener or entry gate, ensure the area is clear. This will prevent potential harm or damage as the gate or garage door will activate during the programme.

CAUTION



This device may suffer from interference if operated in the vicinity of a mobile or fixed station transmitter. This interference is likely to affect the hand-held transmitter as well as the in-car transceiver.

Before programming

CAUTION



When programming a device that may require you to press and re-press the hand-held transmitter (cycle), unplug the device during the cycling process to prevent possible motor failure.

For best results, fit a new battery to the hand-held transmitter of the garage door opener (or other device) before programming. If your garage door opener receiver (located in the garage) is equipped with an antenna, ensure that the antenna is hanging straight down.

To erase all programming

For first time programming, ensure that the engine is switched off:

1. Ensure that the ignition is in convenience mode.
2. Press and hold the two outer buttons on the transceiver in the overhead console. Keep the buttons pressed, the indicator lamp (1) will illuminate. The indicator lamp is located in the middle button.

Convenience features

3. Release the buttons when the lamp begins to flash (this will take approximately 20 seconds).

All memories in the garage door opener have now been cleared.

Note: Do not perform this procedure when programming the additional garage door opener buttons.

Programming the vehicle

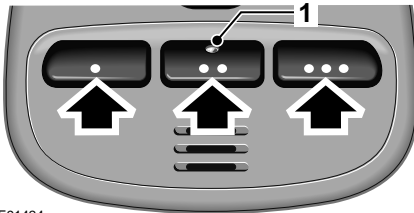

E91424

Ensuring that the engine is switched off:

1. Ensure that the ignition is in convenience mode.
2. Hold the end of the original garage door opener hand-held transmitter approximately 50 to 150 mm (2 to 6 inches) away from the transceiver in the roof console, keeping the indicator lamp in view.
3. Using both hands, simultaneously press and hold both the desired garage door opener button on the overhead console, as shown above, and the **hand-held transmitter button**.
4. Keep both buttons pressed. The indicator lamp (**1**) will flash slowly at first and then change to a fast flash. When the indicator lamp flashes rapidly, release both buttons. The rapid flashing lamp indicates successful programming.

5. If, after 60 seconds, the indicator lamp does not flash rapidly, release both the transceiver and the hand-held transmitter buttons and repeat the procedure starting with Step 2. Position the hand-held transmitter at a different angle and/or distance.
6. Press and hold the programmed overhead console garage door opener button and observe the indicator lamp.
 - If the indicator is continuous, programming is complete and your device should activate when the garage door opener button is pressed and held for approximately 1 to 2 seconds and then released.
 - If the indicator lamp flashes rapidly for two seconds and then illuminates continuously, proceed with the following programming instructions for **rolling code** device equipment.

Note: To programme additional garage door opener buttons, begin at Step 2.

Rolling code device equipment programming

1. At the garage door opener receiver (motor head unit) in the garage, locate the learn or smart button/switch.
 - The name of the button or switch may vary between manufacturers.
2. Press and release the learn or smart button.
3. Return to the vehicle and firmly press and hold the programmed garage door opener button for two seconds and release.
4. Repeat the press, hold, release sequence three times to complete the programming process.

Convenience features

The garage door opener in the overhead console should now activate the **rolling code** device.

Note: *A second person may make the following steps quicker and easier as once the button has been pressed there are only 30 seconds in which to complete Step 3.*

Reprogramming a single garage door opener button

To programme a device to a previously trained button:

1. Press and hold the desired pre-programmed garage door opener button for at least 20 seconds, but no longer than 30 seconds, until the indicator lamp begins to flash.
2. Without releasing the overhead console button, position the hand-held transmitter approximately 50 to 150 mm (2 to 6 inches) away from the transceiver in the overhead console, keeping the indicator lamp in view.
3. Using both hands, simultaneously press and hold both the desired garage door opener button on the overhead console, as shown above, and the **hand-held transmitter button**.

Entry gate programming

The technology of some entry gates requires you to press and re-press (cycle) the hand-held transmitter button every two seconds during programming.

Continue to press and hold the desired overhead console button while you cycle your hand-held transmitter, until the indicator lamp flashes rapidly.

Information and assistance

CAUTION



It is recommended that when you sell or dispose of the vehicle, the programmed transceiver buttons be erased for security purposes.

For information on the range of available compatible products or accessories, or for assistance, you should contact your Jaguar Dealer/Authorised Repairer.

You can also contact the supplier's helpline on 0 0800 0466 354 65. This toll-free number can be called from anywhere within Europe. No separate country code is required (the first zero is not required when calling from within Germany).

Contact can also be made via the internet. The website address is www.eurohomelink.com.

The e-mail address is

info@eurohomelink.com.

Note: *Keep the original transmitter for future use or programming procedures if, for example, you purchase a new vehicle.*

Note: *The manufacturer is not responsible for any radio interference caused by unauthorised modifications to this equipment. Such modifications could void the user's authority to operate the equipment.*

Starting the engine

GENERAL INFORMATION

CAUTION

! **Catalytic converter** - Do not continue to operate the vehicle if any engine malfunction is evident. Misfire, loss of engine performance, excessive oil consumption or engine run-on may lead to unusually high catalytic converter temperatures and may result in damage.

START/STOP button

The START/STOP button is used to start or stop the engine, or to turn on the ignition without starting the engine.

Starting the engine

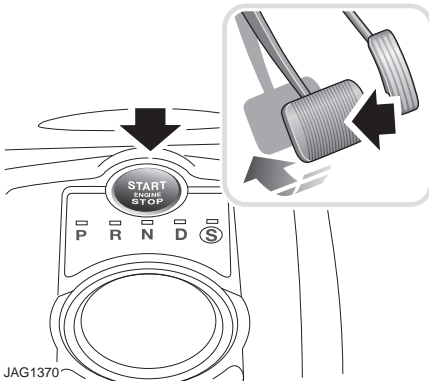

With the brake pedal applied, press and release the START/STOP button. The engine will start and all systems will become functional.

Switching on the ignition

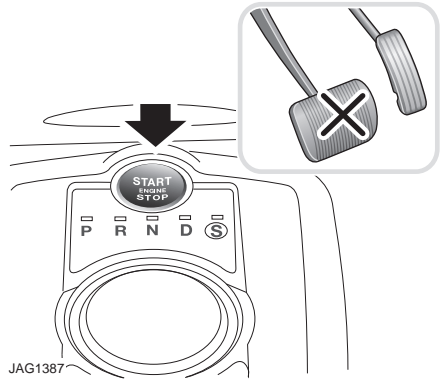

To turn on the ignition system without starting the engine, press the START/STOP button without pressing the brake pedal. All systems will become functional.

Starting the engine

KEYLESS STARTING

WARNINGS



Never start the engine, or leave it running when the vehicle is in an enclosed space. Exhaust gasses are poisonous and can cause unconsciousness and death if inhaled.



Before starting the engine, check the parking brake is on and the gear selector is in position **P** (Park).

With the brake pedal depressed, press the START/STOP button to start the engine. All systems will become functional.

If the engine fails to start

When pressing the engine START/STOP button to start the engine, if the security status lamp, on the top surface of the instrument panel, remains flashing, a fault condition is indicated. Seek qualified assistance as soon as possible.

If the engine persistently fails to start, press the START/STOP button to turn the ignition system back to convenience mode. Slowly depress the accelerator pedal fully, hold it in this position and press the START/STOP button with the brake pedal applied, the engine will start to crank. Release the accelerator pedal when the engine starts.

Note: If the Jaguar Smart Key is placed in the door pocket it may be outside the range of the sensors when the door is opened.

Note: If the fuel system inertia switch has tripped, the ignition circuit will be isolated. See **DRIVING AFTER A COLLISION** (page 230).

SWITCHING OFF THE ENGINE

WARNING



Never switch the engine off when the vehicle is in motion.

With the gear selector in position **P** (Park), press the engine START/STOP button. The engine will stop and the electrical system will return to the convenience mode. The audio, telephone and touch-screen systems will revert to stand-by mode. Pressing the START/STOP button again will activate the systems.

Transmission

AUTOMATIC TRANSMISSION

CAUTIONS

- ❗ Never select the Park (**P**) position whilst the vehicle is in motion. Doing so may cause serious damage to the transmission.
- ❗ Never select the Reverse (**R**) position whilst the vehicle is in forward motion. Doing so may cause serious damage to the transmission.
- ❗ Never select a forward gear whilst the vehicle is in rearward motion. Doing so may cause serious damage to the transmission.
- ❗ Do not rev the engine or allow it to run above normal idle speed while selecting **D** or **R**, or while the vehicle is stationary with any gear selected.
- ❗ Do not allow the vehicle to remain stationary for any length of time, with a gear selected and the engine running. Always select **P** or **N** if the engine is to idle for a prolonged period.

The transmission system is designed to operate in two distinct modes, conventional automatic and Jaguar Sequential Shift.

The automatic modes are accessed by the gear selector:

- **D** - Drive - automatic shifting.
- **S** - Sport - sport automatic shifting.

The Jaguar Sequential Shift mode enables sequential manual gear selection in **D** (temporary) and **S** (permanent) modes, via the steering wheel mounted paddles.

Note: *In addition to the standard shift patterns available in **D** and **S**, the transmission will adapt to differing conditions by modifying shift points, based upon vehicle sensor information for road gradient, cornering, braking pressure and driving style.*

JaguarDrive selector

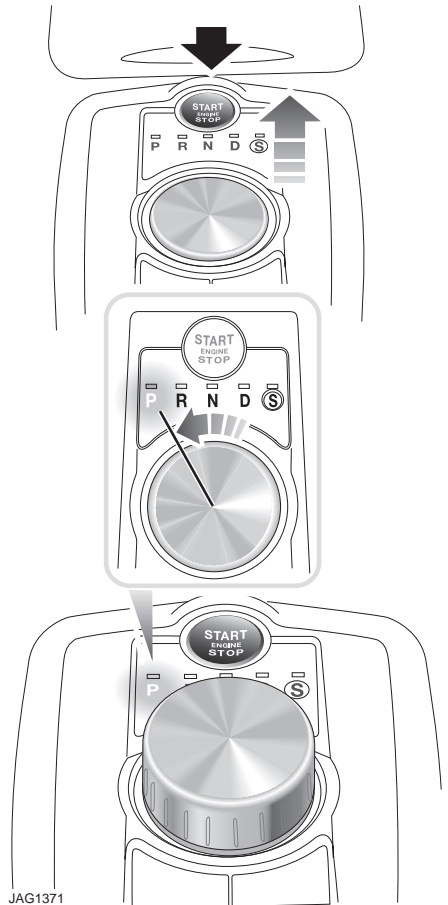

The JaguarDrive selector elevates out of the centre console when the engine is started, in readiness for gear selection. Press the brake pedal, then rotate the control to select the chosen gear (**P**, **R**, **N** or **D**). To select **S** (Sport), rotate the control to **D**, then press down on the control and rotate to select **S**.

Transmission

P should be selected before switching off the engine. However, it is possible to switch the engine off with **R**, **D** or **S** selected - the selector will automatically select **P**, while retracting into the centre console.

Note: *If the engine is switched off with **N** selected, the system will wait for 10 minutes before selecting **P**. This procedure is to allow the vehicle to be conveyed through a car wash only and should not be used for vehicle recovery purposes.*

Selector positions

P - Park: Use when parked. In this position the transmission is locked, do not attempt to select **P** if the vehicle is moving.

Note: ***P** will be selected automatically when the engine is switched off.*

R - Reverse: Do not select if the vehicle is moving forward.

N - Neutral: Disconnects drive to the wheels. Use the parking brake when stopping temporarily with **N** selected.

D - Drive: Gear changing is automatic for all six forward gears. The shift points are determined by accelerator pedal position and road speed, to provide the best balance of performance, refinement and fuel economy, for the large majority of driving conditions.

S - Sport: Gear changing is automatic for all six forward gears, with modified gear shift points to maximise the vehicle response in demanding driving conditions. This mode is not suitable for town or highway cruising.

Note: *Both **D** and **S** positions also offer additional features, which are listed under **Automatic mode** and **Sport mode**, later in this section.*

Stationary vehicle

CAUTION



It is **not** recommended to leave the selector in the **D** or **S** positions for any length of time while the vehicle is stationary.

When the vehicle is stationary for a short period of time (e.g. in stop-start traffic), the selector may be left in **D** or **S**. When stopping for extended periods, either select **P** or apply the parking brake and select **N**.

Selector interlock

The transmission is equipped with an interlock, to prevent inadvertent selection of a drive gear (**D**, **S** or **R**) from the **P** or **N** positions. To release the interlock to select a drive gear, press the brake pedal while making the selection.

Ensure the required driving range has selected prior to releasing the brake pedal. The range indicator (**R**, **D** or **S**) on the selector and message centre displays, will illuminate continuously to confirm selection.

Note: *If the brake pedal is released too early during selector rotation from **P** or **N** to a driving range (**R**, **D** or **S**), then the selected range will **not** be engaged. The selected range will **flash** on the selector and message centre displays.*

*To obtain the selected range, press the brake pedal, select **P** or **N** and reselect the required range, ensuring the brake pedal is depressed.*

If **N** is selected for less than 2 seconds (e.g. when moving the selector between **R** and **D**), the interlock will not activate and the brake pedal will not need to be pressed.

Note: *The interlock is deactivated when the vehicle is travelling at more than 5 km/h (3 mph).*

Transmission

If the selector fails to elevate

If the JaguarDrive selector is obstructed when the engine is started, it may be prevented from elevating out of the centre console. If this occurs, turn off the ignition, ensure that the selector is not obstructed and then start the engine. The selector should elevate as normal.

If the selector still fails to elevate, even if there is no obstruction, a fault in the system is indicated. The selector can still be used in the lowered position, but be aware that it will not automatically select **P** when the engine is switched off, so **P** should be selected manually. The fault should be rectified by a Dealer/ Authorised Repairer at the earliest opportunity.

Starting

In the unlikely event that the selector did not rotate back to **P** when the vehicle was previously switched off, and the selector has remained in **R**, **D** or **S**, it will not be possible to start the engine. The vehicle will go to ignition on. The selected range will flash and the selector will now be unlocked, to allow the driver to select **P** and start the engine.

Automatic mode

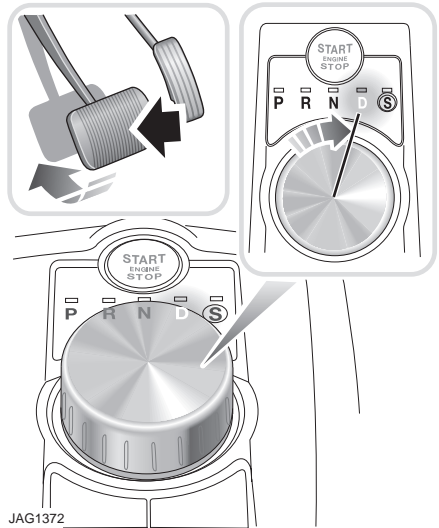

To select Drive (**D**) when the vehicle is stationary:-

1. Apply the foot brake.
2. Rotate the gear selector to **D**.

When in **D** the transmission will automatically select the most appropriate gear for the current driving conditions.

Note: When a gear is selected the vehicle may begin to move as soon as the foot brake is released.

Kick-down

When **D** is selected and the accelerator pedal is depressed fully, the transmission will downshift to the lowest appropriate gear. Once the accelerator pedal is returned to a normal driving position, the transmission will up-shift to the highest appropriate gear.

Note: Kick-down operation will vary according to road speed, current gear in use and accelerator movement.

Transmission

Fast off

Activated when rapidly lifting off the accelerator pedal and takes account of road gradient. This feature inhibits up-shifts, enhancing performance.

Note: If Sport mode is selected, driver type recognition will vary the activation of this feature according to driving style.

Shift adapt under braking

Under braking, the transmission will vary the down-shift point in proportion to braking effort and road gradient. This feature works in conjunction with the positive torque function, resulting in a smoother down-shift.

Note: If Sport mode is selected, driver type recognition will vary the activation of this feature according to driving style.

Corner recognition

Inhibits up-shifts during cornering, to provide improved vehicle balance.

Note: If Sport mode is selected, driver type recognition will vary the activation of this feature according to driving style.

Road gradient recognition

When the vehicle is being driven on an uphill gradient, the transmission adapts the shift pattern to make better use of engine power.

When driving on a long downhill gradient, the transmission may automatically select a lower gear, to increase engine braking. Selecting Sport mode (S) will increase the tendency of the transmission to select a lower gear in these conditions, further increasing engine braking.

Note: It is also possible to manually select a lower gear to increase engine braking via use of the shift paddles.

Sport mode

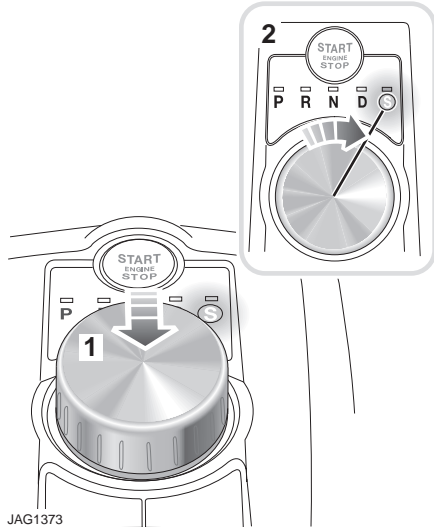

To select Sport mode:

1. With **D** selected, push down on the selector.
2. Rotate from **D** to **S**.

CAUTION



It is **not** recommended to push the selector down in the **P**, **R** or **N** positions.

Note: When Sport mode is selected **SPORT** will be displayed in the message centre, and the selector indicator will illuminate.

Sport mode enhances the responsiveness of the transmission, to provide a sporting feel to driving the vehicle. Sport mode is recommended for overtaking manoeuvres and for when rapid progress is desired.

To return to automatic mode move the selector lever back to the **D** position. The **D** on the selector display will illuminate to confirm that automatic mode has been selected.

Transmission

Driver type recognition

In Sport mode, the transmission monitors driving style and in combination with sensors in the vehicle, varies the shift schedule, fast-off, corner recognition and shift adapt under braking functions, according to the driving style.

Manual mode - Jaguar Sequential Shift

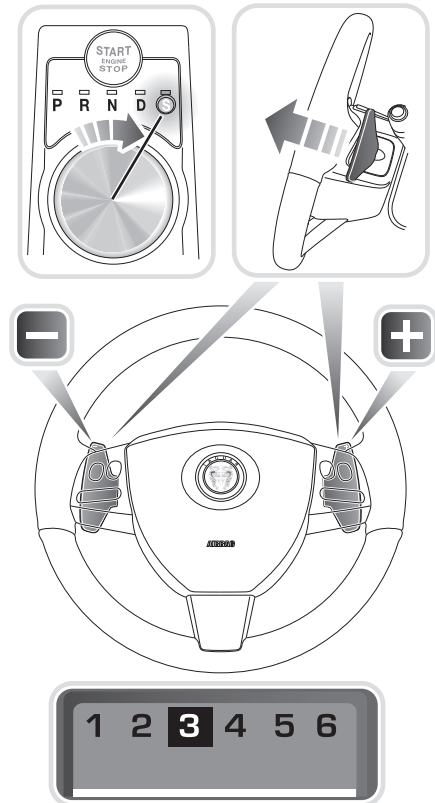

JAG1374

Shifts in the Jaguar Sequential Shift manual mode are made using the steering wheel mounted shift paddles and are optimised to provide a rapid response to gear shift requests.

Up-shift requests (+) are optimised for performance via the short shift function, resulting in firmer feeling shifts than in automatic mode. Down-shift requests (-) utilise a throttle blip during the shift, resulting in improved shift feel.

The Jaguar Sequential Shift manual mode can be accessed either temporarily, or permanently.

Temporary manual gear selection: When the gear selector is in the **D** position, manual mode may be directly accessed by the single action of operating the steering wheel mounted shift paddles.

This convenience feature allows immediate but temporary use of the shift paddles when the gear selector is in **D**.

If continued use of manual mode is required, the gear selector may be subsequently moved to the **S** position to enter permanent manual mode in the currently selected gear.

If the gear selector remains in the **D** position, temporary manual mode will be held whilst the driver is accelerating, decelerating, cornering or continuing to request shifts via the paddles.

The transmission will revert to automatic operation after a short period of driving at steady speed; alternatively the shift-up (+) paddle may be held for a short period (approximately one second) to return directly to automatic operation in **D**.

Permanent manual gear selection: Select the **S** position, permanent manual mode is then accessed by the operation of the steering wheel mounted shift paddles.

The message centre will highlight the currently selected gear.

Transmission

Note: When the transmission is set to permanent manual mode (i.e. using the paddles to change gear while in Sport mode) and Dynamic mode is selected, transmission up-shifts are fully controlled by the driver. This means that the transmission will not change up a gear automatically, even when the vehicle's rev limit is reached. When the rev limit is reached, the gear position indicator in the message centre will glow amber, to indicate that the next gear should be selected.

To exit from the **Jaguar Sequential Shift** permanent manual mode, either pull and hold the shift-up paddle for approximately one second (to return directly to automatic operation in **S**), or rotate the gear selector to the **D** position. The transmission will revert to the **D** automatic shift mode.

Manual operation

To shift-up, briefly pull the shift-up (+) paddle on the right-hand side of the steering wheel towards you.

To shift-down, briefly pull the shift-down paddle (-) on the left-hand side of the steering wheel towards you.

The message centre display will change to highlight the requested gear.

Note: The transmission will inhibit up-shifts and down-shifts if the requested shift would result in an engine speed outside the normal operating range of the engine. If this occurs, the message centre will briefly display the requested gear selection, but will return to displaying the current gear.

The **Jaguar Sequential Shift** mode also has the following features:

Kick-down: Operation of kick-down in **Jaguar Sequential Shift** mode will override the currently selected gear. The lowest available gear will be selected for maximum acceleration and will be highlighted in the message centre display. Subsequent manual shifts may then be selected as usual.

Positive torque: Provides throttle blips on down-shifts, improving shift feel and response.

Shift assist: The transmission will automatically up-shift at the engine speed redline in **Jaguar Sequential Shift** mode, as if commanded manually.

The transmission will automatically down-shift, when the engine speed drops too low for the currently selected gear.

When the vehicle approaches, or comes to rest, second gear is automatically selected.

Subsequent pull-aways will occur in second gear, unless the accelerator pedal demand is high or a down-shift is manually selected, in which case, first gear will be selected.

In all cases the message centre will display the current gear.

Note: During sustained braking, if a down-shift is selected at a speed which would result in the engine speed exceeding its normal operating range, the gear change will be indicated in the message centre, but the down-shift will be delayed until the vehicle speed has reduced sufficiently for the gear selection to be made, without causing the engine speed to exceed its normal operating range.

Limp-home mode

Note: The driver should be aware that the vehicle's performance will be reduced and must take this into account when driving. Also the use of the **Jaguar Sequential Shift** paddles will be disabled. In this event, seek qualified assistance as soon as possible.

Transmission

In the unlikely event of an electrical or mechanical failure, transmission operation will be limited. The vehicle gear selector ranges **P**, **R**, **N**, **D** and **S** may still be used to enable the vehicle to be driven to a safe area.

Some faults will cause the selector to be locked in position until the ignition is switched off. If the selected range flashes, it signifies that the driver request cannot be engaged. Re-select **N** and repeat the attempt.

If the transmission is still unable to select the requested gear, contact your Dealer/ Authorised Repairer.

Message centre display

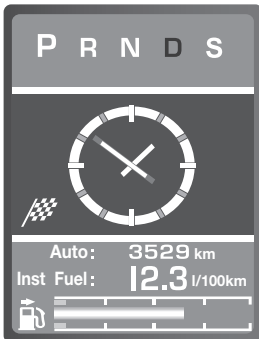

JAG1375

The message centre will confirm the JaguarDrive selector position (selected gear).

Selector position is shown highlighted at the top of the message centre and confirmed by the dot on the circular representation of the selector.

If manual mode is selected, the numbers **1** to **6** appear at the top of the display, with the currently selected gear highlighted.

Note: With the transmission set to permanent manual mode and Dynamic mode selected, when the rev limit is reached, the gear position indicator in the message centre will glow amber, to indicate that the next gear should be selected.

The message centre may also display the following messages with associated warning indicators:

ENGINE SYSTEMS FAULT (Red)

RESTRICTED PERFORMANCE (Red or Amber)

GEARBOX FAULT (Amber)

If any of these messages are displayed it is likely that loss of power or driveability will be experienced. Seek qualified assistance as soon as possible.

Brakes

PRINCIPLE OF OPERATION

WARNINGS



It remains the driver's responsibility to drive safely according to prevailing conditions.



Do not rest your foot on the brake pedal whilst the vehicle is in motion.

This may cause a light application of the brakes, which can result in overheating, reduced brake performance, and excessive brake wear.



If the red brake warning indicator illuminates, safely bring the vehicle to a stop, as quickly as possible. Seek qualified assistance before proceeding.



Never place non-approved floor matting or any other obstructions under the brake pedal. This restricts pedal travel and braking efficiency.

Brake pads

Brake pads require a period of bedding in when new. Drive with extra caution for the first 800 km (500 miles), to avoid the need for heavy braking.

Brake pad wear warning

When the brake pads are wearing low, the warning message **BRAKE PADS LOW** is displayed in the message centre. Arrange for your vehicle to be seen by your Dealer/ Authorised Repairer at the earliest opportunity.

Wet conditions

Driving through heavy rain or water, can have an adverse effect on braking efficiency. Under those circumstances, it is recommended that you lightly apply the brakes intermittently, to dry the brakes.

Brake system warning indicators



If this amber warning indicator illuminates while driving and/or **ABS FAULT** is displayed in the message centre, drive with extra caution, avoid heavy braking where possible, and seek qualified assistance as soon as possible.



If this red warning indicator illuminates while driving and/or the message **LOW BRAKE FLUID** is displayed in the message centre, check the brake fluid level at the earliest opportunity and top-up as required. See **BRAKE FLUID CHECK** (page 187).

HINTS ON DRIVING WITH ABS

WARNINGS



ABS cannot overcome the physical limitations of braking distance. Nor can it overcome the lack of grip on a road surface (e.g. if aquaplaning on water).



Braking distance is increased on a slippery surface. This applies to all vehicles, even those fitted with ABS.



The driver should not be tempted to take risks when driving, in the hope that ABS will correct errors of judgement. In all cases, it remains the driver's responsibility to drive with due care and attention, paying particular attention to the effects of speed, weather, road conditions etc.

ABS (Anti-lock Braking System) allows maximum brake pressure, and thus maximum braking efficiency, to be applied and prevents the road wheels locking. This allows the driver to retain steering control during heavy braking under most road conditions.

ABS optimises tyre to road adhesion under maximum braking conditions, though it cannot provide increased cornering ability.

Brakes

During emergency braking conditions, ABS constantly monitors the speed of each wheel. ABS varies the brake pressure to individual wheels, according to the grip available. The constant alteration of brake pressure can be felt as a pulsing sensation through the brake pedal. This is not a cause for concern, as it is designed to demonstrate to the driver that ABS is operating.

ABS braking techniques

For optimum ABS performance, these instructions on braking techniques during ABS operation should be followed:

- Do not release the brake pressure when the pulsating effect is felt. Maintain a constant pressure until the manoeuvre is completed.
- To familiarise yourself with the feel of the brake pedal during ABS braking, practise an emergency stop procedure, always making sure it is safe to do so. With the seat belts fitted to all occupants, drive the vehicle at 32 km/h (20 mph) and fully apply the brakes.
- ABS enables the driver to steer around obstacles during emergency braking. However, the consequences of turning sharply at high speed, cannot be overcome by the ABS.
- Do not attempt to pump the brakes to avoid skidding, as this can interfere with ABS operation. The ABS will not allow the wheels to skid under normal road conditions.
- The ABS will tend to keep the vehicle straight during braking. Because braking distances may increase under certain road conditions, it is necessary to plan and make turning manoeuvres as early as possible.

Electronic Brakeforce Distribution (EBD)

EBD balances the distribution of braking forces between the wheels on the front and rear axles, to maintain maximum braking under all vehicle loading conditions.

For example: Under light loads, EBD applies less braking effort to the rear wheels, to maintain stability. Conversely, it allows full braking effort to the rear wheels when the vehicle is heavily laden.



A fault with the EBD system is indicated by the illumination of the red brake warning indicator and the message **EBD FAULT** is displayed in the message centre. Gently stop the vehicle, as soon as safety permits and seek qualified assistance.

Emergency Brake Assist (EBA)

WARNING



The EBA system is an additional safety system; it is not intended to relieve the driver of his or her responsibility for exercising due care and attention when driving.

The EBA system measures the rate at which the brake pressure increases. If the system detects an emergency braking situation, EBA automatically initiates full braking effect. This can reduce stopping distances in critical situations.

EBA stops operating as soon as the brake pedal is released.



EBA is part of the Dynamic Stability Control (DSC) system and a fault with the EBA system is indicated by the amber DSC warning indicator illuminating and **DSC NOT AVAILABLE** (with amber backlight) displaying in the message centre. Seek qualified assistance as soon as possible.

Brakes

ELECTRIC PARKING BRAKE (EPB)

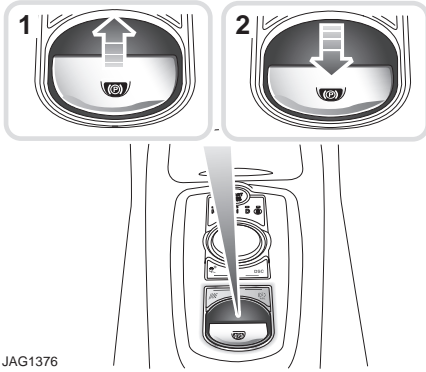

JAG1376

The switch which operates the parking brake is mounted on the centre console to the rear of the gear selector.

1. To engage the parking brake: Pull the switch upwards and release. The switch will return to the neutral position. The parking brake warning and brake fluid low warning indicator on the instrument panel will illuminate.

The Drive Away Release feature allows the parking brake to release automatically as the vehicle is driven away.

2. To disengage the parking brake: With the ignition on or with the engine running, apply the foot brake and press the parking brake switch down.

If the parking brake is applied while the vehicle is stationary and **D** or **R** is selected, applying the throttle will automatically release the parking brake.

The parking brake is also automatically released when the gear selector is moved from **P** position.

If the parking brake is operated while the vehicle is moving at speeds in excess of 3 km/h (1.8 mph), the message **PARK BRAKE APPLIED** is displayed in the message centre, the warning indicator in the instrument panel will illuminate and a warning chime sounds.

If the parking brake is applied while the vehicle is moving, releasing the switch will disengage the parking brake.

The parking brake cannot be applied while the vehicle is moving, if the accelerator pedal is pressed.

Note: *If the vehicle is in motion, the parking brake should only be used as an emergency brake.*

CAUTION

 Take care that the vehicle is safely parked, to prevent it from rolling, if you wish to leave the parking brake off. However, it is advisable to always use the parking brake.

The warning indicator in the instrument panel will remain on for a short time, if the parking brake is applied when the ignition system is reverted to convenience mode.

If a fault in the system is detected, the message **PARK BRAKE FAULT** or **CANNOT APPLY PARK BRAKE** will be displayed. Seek qualified assistance as soon as possible.

If the battery has been discharged or disconnected, the message **APPLY FOOT AND PARK BRAKE** will be displayed when the ignition is next switched on. Depress the foot brake and apply the parking brake. This is required to reset the parking brake system. The parking brake will now function correctly.

Parking aid

PRINCIPLE OF OPERATION

WARNINGS



It remains the driver's responsibility to be vigilant when reversing. Small children or animals may not be detected by the system.



It remains the driver's responsibility to detect obstacles and estimate the car's distance from them. Some overhanging objects, barriers, thin obstructions or painted surfaces, which could possibly cause damage to the vehicle, may not be detected by the system. Always be vigilant when reversing.

CAUTIONS



Objects moving away from the vehicle will be reported. However, whilst driving away, object warning may be temporarily reported due to ground reflection.



Systems using the same frequency band as the front parking sensors, may cause irregular tones to be emitted.

The parking aid provides the driver with information on most obstructions, and their distance from the vehicle, when manoeuvring. This is achieved by using four ultrasonic sensors on each bumper.

When objects are detected the parking aid emits an audible warning tone which increases in frequency as the vehicle gets closer to the object.

The parking aid is automatically in standby when the ignition system is on.

USING THE PARKING AID

Touch-screen

To set the preferences of the parking aid, the settings are accessed via the Home menu. Select **Veh. settings**.

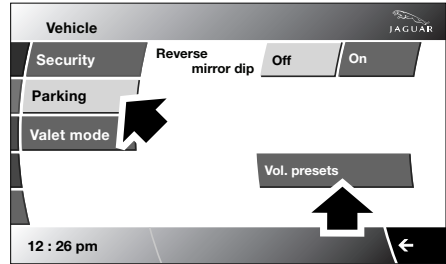

E91477

Select **Parking**.

There is a link to **Vol. presets** in order that the volume of the parking aid warning tones may be adjusted.

Note: The volume adjusts both front and rear speaker volume.

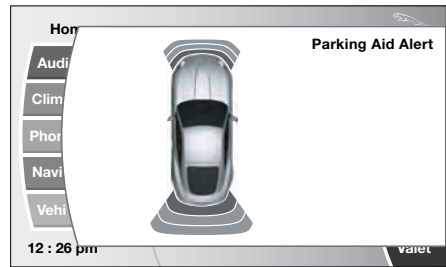

E91478

When the reverse parking aid is active, a pop-up screen is initiated displaying the area of the vehicle. This can be cancelled by touching the screen within the pop-up area.

Parking aid

Front and rear parking aid

CAUTION

 The parking aid automatically switches off when the vehicle is moving above 15 km/h (9 mph) and requires to be switched on again when moving below 15 km/h (9 mph).

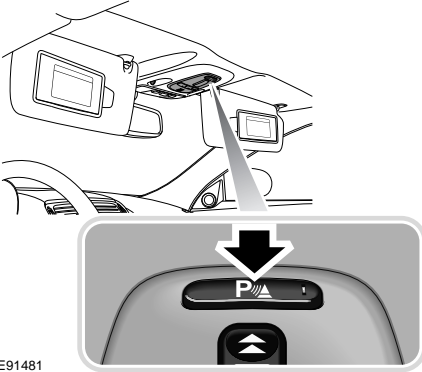

E91481

The parking aid switch is located in the overhead console.

Pressing the switch turns both the front and rear parking aids on or off. The switch indicator lamp will come on when the system is turned on or if a fault is detected in the system.

Note: *The front parking aid will also operate when reverse gear is selected.*

The parking aid provides an audible proximity warning when driving forwards or reversing.

The front and rear sensors only operate within a fixed speed range in forward gears and are not effective when moving forwards at speeds above 15 km/h (9 mph).

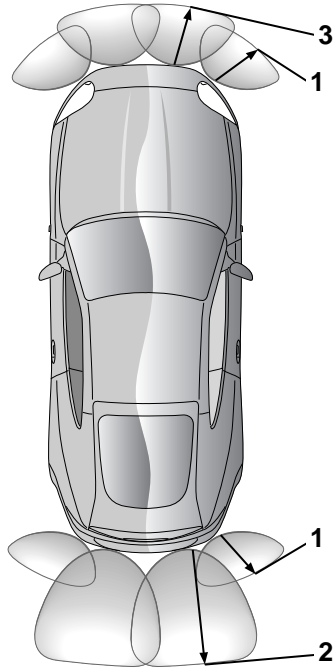

E91482

1. Approximately 600 mm (24 inches).
2. Approximately 1800 mm (71 inches).
3. Approximately 800 mm (31 inches).

Objects are detected within the operating ranges shown in the illustration above.

If an obstacle is detected at the front or rear of the vehicle, a warning tone will be heard from the front or rear speaker respectively.

Note: *The outer rear sensors (1) will show visual detection on the message centre before the audible warning is given.*

The warning tone increases in rate as the vehicle approaches the obstacle.

The warning tone will become continuous when the obstacle is detected at, or within, 300 mm (12 inches) from the vehicle.

Parking aid

If the system has a fault when engaging reverse gear or turning on the ignition, then a single, three second tone will be heard (only once per ignition cycle) and, if fitted, the switch indicator light will flash for three seconds and then switch off. The system is automatically disabled when a fault is detected.

Rear fitted accessories

Particular care must be taken when reversing with rear fitted accessories (e.g. a bicycle carrier), as the rear parking aid will only indicate the distance from the bumper to the obstacle.

System fault

The parking aid may sound spurious tones, if it detects a frequency using the same band as the sensors.

Cleaning the sensors

Do not clean the sensors with abrasive or sharp objects or materials.

For reliable operation, the sensors in the front and rear bumpers should be kept free from ice, frost and grime.

When using a high pressure spray the sensors should only be sprayed briefly and not from a distance of less than 200 mm (8 inches).

Driving hints

RUNNING-IN

Apart from a few precautionary recommendations, there are no strict running-in procedures for this vehicle.

By observing the following advisory precautions you will ensure maximum engine, transmission and brake life for your vehicle.

Engine

- Allow the engine to reach operating temperature, before operating at engine speeds over 3 500 rev/min.
- Vary the speed frequently.
- From 1 500 km (940 miles) onwards, engine speed and acceleration can be gradually increased.

Engine oil consumption

A certain amount of oil consumption is normal. The rate of consumption will depend on the following:

- The quality and viscosity of the oil.
- Climatic conditions.
- The speed at which the engine is being operated.
- Road conditions.

Drivers should expect above normal consumption when the engine is new, and after running-in if high speeds are sustained.

Brakes

To ensure that brake pads reach their optimum wear and performance condition, usually within 500 km (300 miles), it is recommended that the following points are observed.

- Where possible, avoid heavy or harsh braking, as this can result in damage to the brake pads and discs.
- Avoid prolonged use of the brakes, for example, when descending severe gradients.
- Frequent light application of the brakes is desirable. This helps to fully bed-in the brake pads.

These running-in guidelines also apply when new brake discs or pads have been fitted.

Final drive unit

During the first 1 500 km (940 miles):

- Avoid full throttle applications and do not exceed 190 km/h (120 mph). Observe the national speed limits in the country in which you are travelling.
- Do not participate in motor racing events, track days, sports driving schools or similar for the first 8 000 km (4 975 miles).

Driving hints

ECONOMICAL DRIVING

There are two main factors which influence fuel economy, the way the vehicle is driven and maintenance.

Driving tips for economy

- Avoid unnecessary journeys, especially short stop-start trips.
- Accelerate smoothly and gently from a stand still.
- Allow time to brake gently and smoothly.
- Be aware of traffic and road conditions ahead, and take action in time to avoid hard braking or acceleration.
- When stationary apply the parking brake and select neutral.
- Turn off the air conditioning when not needed.

Maintenance and fuel economy

Regular servicing by a Jaguar Dealer/Approved Repairer, along with regular checks by the driver, are essential for vehicle longevity and fuel economy.

The condition of the engine (oils, filters, spark plugs, settings etc.), tyre pressures and wheel alignment, will all have a bearing on fuel economy. For this reason, it is essential that the vehicle is checked regularly by the driver, and serviced by an approved Jaguar Dealer/Authorised Repairer at the correct intervals.

Note: *If you are in any doubt about the maintenance requirements, intervals, or checks required, contact your Jaguar Dealer/Authorised Repairer for advice.*

Cruise control

PRINCIPLE OF OPERATION

Cruise control enables the driver to maintain a constant road speed without using the accelerator pedal. This is particularly useful for motorway cruising, or for any journey where a constant speed can be maintained for a lengthy period.

The cruise (speed) control system can be used by the driver to maintain a selected vehicle speed above 30 km/h (18 mph).

Adjustment controls on the steering wheel, allow the driver manual control of the system. Brake operations also influence the cruise control system.

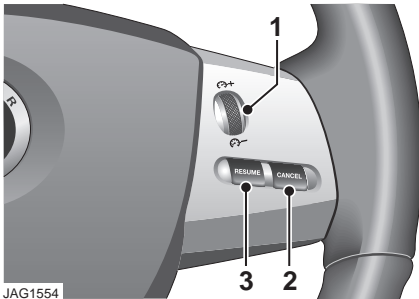

1. The speed adjustment control thumb wheel is used to engage cruise control initially, by rolling it upwards. It is also used to increase (+) or decrease (-) the set speed, until the desired speed is obtained.

2. CANCEL - Cancels cruise control, but retains the set speed in memory.

3. RESUME - Resumes the cruise control set speed, after it has been cancelled.

USING CRUISE CONTROL

Setting vehicle speed

WARNING



Only use cruise control when conditions are favourable. For example, straight, dry, open roads with light traffic.

When you are travelling at the speed you require, which must be above 30 km/h (18 mph), roll the speed adjustment control (1) upwards or downwards, to increase or decrease speed.

Cruise control will engage and maintain the set speed and you can remove your foot from the accelerator pedal.

Note: Cruise control automatically disengages when the brake pedal is pressed or when the vehicle speed falls below 30 km/h (18 mph).

Changing the speed

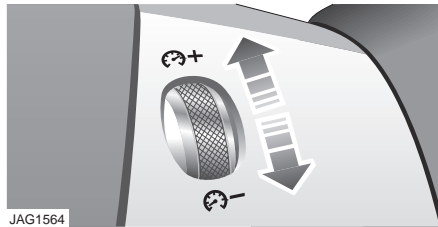

There are two ways to change the set speed:

- Accelerate or decelerate to the desired speed then roll the speed adjustment control upwards (+).
- Increase or decrease the speed by rolling the speed adjustment control upwards (+) or downwards (-), until the desired speed is obtained.

Cruise control

Note: The set speed can be adjusted in steps of 2 km/h (1 mph), by rolling the thumbwheel control upwards (+) or downwards(-) briefly, until the desired speed is obtained.

Resuming the speed

If the vehicle is accelerated above the set speed, then the set speed will be resumed when the accelerator pedal is released.

If **CANCEL** is pressed, or the brake pedal is pressed, the cruise control will disengage but the set speed memory will be retained. Press **RESUME** and the vehicle will return to the set speed.

Note: Cruise control will not resume at speeds below 30 km/h (18 mph).

RESUME will not operate if the ignition has been turned off.

CAUTIONS



RESUME should only be used if the driver is aware of the set speed and intends to return to it.



It is not recommended to resume set speed when a low gear is selected, as excessive engine speeds will occur.

Cruise control will switch off and clear the memory when:

- The ignition is switched off.
- A fault occurs. The cruise control system will switch off and cannot be used until the fault is cleared.

Automatic switch off

Cruise control will switch off but the set speed will remain in the memory when:

- The **CANCEL** button is pressed.
- The brake pedal is pressed.
- Speed falls below 30 km/h (18 mph).
- Neutral, Park or Reverse gear positions are selected.
- Dynamic Stability Control is operating.
- The difference between the actual and set speed is too great.
- When the vehicle reaches a speed of 192 km/h (120 mph).
- The accelerator pedal is used to accelerate beyond the set speed for too long a period.

Message centre information displays

Message	Meaning
CRUISE ENGAGED	Displayed when cruise control system is operating.
CRUISE OVERRIDE	Driver is pressing the accelerator pedal overriding cruise control function. Message will disappear when accelerator pedal is released and cruise control speed is resumed.
CRUISE CANCELLED	Driver has cancelled cruise control or is braking.
CRUISE NOT AVAILABLE	Cruise control or Adaptive Cruise Control malfunction.

Adaptive cruise control (ACC)

PRINCIPLE OF OPERATION

The Adaptive Cruise Control (ACC) system is designed to assist the driver in maintaining a gap from the vehicle ahead, or maintaining a set road speed, if there is no slower vehicle ahead. The system is intended to assist the driver, when following other vehicles which are in the same lane and travelling in the same direction.

WARNING



ACC is not a collision warning or avoidance system. Additionally, ACC will not react to:

Stationary vehicles or vehicles moving at less than 10 km/h (6 mph).

Pedestrians or objects in the roadway.

Oncoming vehicles in the same lane.

The ACC system is based on the use of a radar, which projects a beam directly forward of the vehicle, to detect objects ahead.

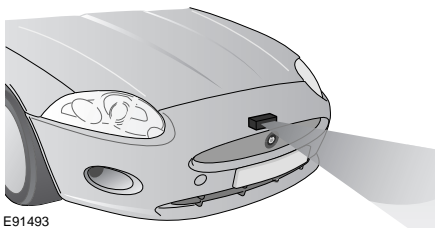

E91493

The radar is mounted centrally behind the bumper, above the grille, to provide a clear view forward for the radar beam.

USING ACC

WARNING



Only use ACC when driving on main roads, with free flowing traffic.



Do not use in poor visibility, specifically fog, heavy rain, spray or snow.



Do not use on icy or slippery roads.



It is the driver's responsibility to stay alert, drive safely and be in control of the vehicle at all times.



Keep the front of the vehicle free from dirt, metal badges or objects, including vehicle front protectors, which may interfere with radar operation.



Do not use ACC when entering or leaving a motorway.

The system is operated by controls mounted on the steering wheel. The driver can also intervene at any time by use of the brake or accelerator pedal.

Adaptive cruise control (ACC)

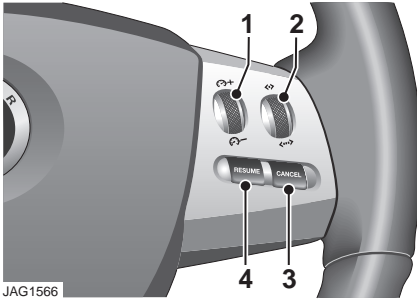

The steering wheel controls operate as follows:

- 1. Speed adjust control:** Use the thumbwheel to set the speed. Rotate upwards (+) to increase, or downwards (-) to decrease the set speed.
- 2. Gap increase or decrease:** Four gap settings are selectable by adjusting the thumbwheel.
- 3. CANCEL** - Cancels but retains the set speed in memory.
- 4. RESUME** - Resumes the set speed after it has been cancelled.

Setting the speed

Accelerate as normal until the required speed is reached.

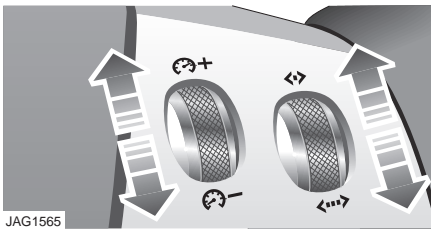

Briefly rotate the speed adjust control upwards (+), to store the speed in the memory and engage the system.

SET SPEED

80 KM/H (50 MPH)

The set speed will be displayed on the message centre:

Changing the speed

There are three ways to change the set speed:

- Accelerate or brake to the desired speed then briefly rotate the speed adjust control upwards (+).
- Increase or decrease the speed by rotating the speed adjust control upwards (+) or downwards (-), until the required set speed is shown on the message centre. The vehicle speed will gradually change to the selected speed.
- Increase or decrease the speed in steps of 2 km/h (1 mph), by briefly rotating the speed adjust control upwards (+) or downwards (-), until the desired speed is obtained.

ACC operates between approximately 34 km/h and 180 km/h (21 mph and 112 mph) dependent on the country specification.

Set speeds outside this range will not be captured.

The ACC may apply the brakes to slow down the vehicle to the new set speed. The new set speed will be displayed on the message centre until ACC is cancelled.

Adaptive cruise control (ACC)

Follow mode gap settings

WARNING



When in follow mode, the vehicle will not decelerate automatically to a stop, nor will the vehicle always decelerate quickly enough to avoid a collision without driver intervention.

Once a set speed has been selected, the accelerator can be released and the set road speed will be maintained.

When a vehicle ahead enters the same lane or a slower vehicle is ahead in the same lane, the vehicle speed will be adjusted automatically until the gap to the vehicle ahead corresponds to the preset gap (Gap 3, identified by 3 chevrons is the default). The vehicle is now in follow mode.



The warning indicator in the instrument panel will be illuminated.

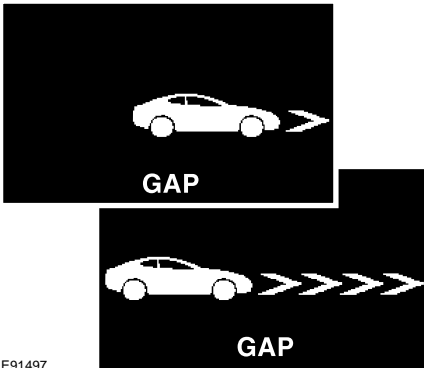

E91497

The message centre will display the gap set. The shortest (Gap 1), represented by 1 chevron, and the longest (Gap 4), represented by 4 chevrons, are illustrated above.

The vehicle will then maintain the time gap to the vehicle ahead, until:

- The vehicle ahead accelerates to a speed above the set speed.
- The vehicle ahead moves out of lane or out of view.
- A new gap distance is set.

If necessary, the brakes will be automatically applied to slow the vehicle, to maintain the gap to the vehicle in front.

The maximum braking which is applied by the ACC system is limited and can be overridden by the driver applying the brakes, if required.

Note: *Driver braking will cancel ACC.*

If the ACC system predicts that its maximum braking level will not be sufficient, then an audible warning will sound while the ACC continues to brake. **DRIVER INTERVENE** will be displayed on the message centre. The driver should take immediate action.

When in follow mode, the vehicle will automatically return to the set speed when the road ahead is clear, for instance when:

- The vehicle in front accelerates or changes lane.
- The driver changes lane to either side or enters an exit lane.

The driver should intervene if appropriate.

Adaptive cruise control (ACC)

Changing the follow mode set gap

The gap to the vehicle ahead can be adjusted by rotating the gap increase/decrease control on the steering wheel. Four gap settings are available and the selected gap is represented by the corresponding number of chevrons in front of the car icon displayed on the message centre (Gap1 = 1 chevron, Gap 4 = 4 chevrons). After the ignition is switched on, the default gap setting (Gap 3), will be automatically selected ready for ACC operation.

Note: When the ignition is switched off, the gap setting will revert to the default setting (Gap 3) when switched on again.

Note: It is the driver's responsibility to select a gap appropriate to the driving conditions.

Overriding the speed and follow mode

WARNING



Whenever the driver overrides the ACC by pressing the accelerator pedal, the ACC will not automatically apply the brakes to maintain the gap to any vehicle ahead.

The set speed and gap can be overridden by pressing the accelerator pedal when cruising at constant speed or in follow mode. If the vehicle is in follow mode, the warning indicator will extinguish when the ACC is overridden and **CRUISE OVERRIDE** will be displayed in the message centre. When the accelerator is released, ACC will operate again and vehicle speed will decrease to the set speed, or a lower speed when appropriate if follow mode is active.

Automatic low speed switch off

If vehicle speed decreases below 30 km/h (18 mph), the ACC system automatically switches off and the warning indicator will extinguish.

If the brakes were being applied by the ACC system, they will be slowly released.

This will be accompanied by an audible warning and **DRIVER INTERVENE** will be displayed in the message centre. The driver must take control.

Automatic switch off

ACC will disengage, but not clear the memory, when:

- The **CANCEL** button is pressed.
- The brake pedal is pressed.
- Neutral, Park or Reverse gear positions are selected.
- Dynamic Stability Control activates.

ACC will disengage, and clear the memory, when:

- The ignition is switched off
- Maximum vehicle speed is reached
- A fault occurs in the ACC system.

Resuming the speed and follow mode

CAUTION



RESUME should only be used if the driver is aware of the set speed and intends to return to it.

By pressing the **RESUME** button after ACC has been cancelled (e.g. after braking), the ACC will become active again, provided that the set speed memory has not been erased. The set speed will be displayed for four seconds and the original set speed will be resumed, unless a vehicle ahead causes follow mode to become active.

Adaptive cruise control (ACC)

Hints on driving with ACC

The system acts by regulating the speed of the vehicle using engine control and the brakes. Gear changes may occur in response to deceleration or acceleration whilst in ACC.

ACC is not a collision avoidance system. However, during some situations, the system may provide the driver with an indication that intervention is required.

An audible alarm will sound, accompanied by the message **DRIVER INTERVENE**, if the ACC detects:

- A failure has occurred while the system is active.
- That using maximum ACC braking only is not sufficient.

Note: ACC operates when the gear selector lever is in position **S** or **D**.

Note: When engaged, the accelerator pedal rests in the raised position. Fully release the pedal to allow normal ACC operation.

Note: When braking is applied by the ACC, the vehicle brake lamps will be switched on although the brake pedal will not move.

Detection beam issues

1

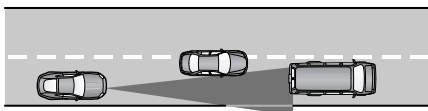

2

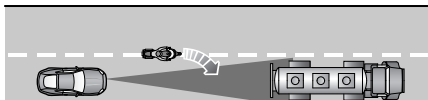

3

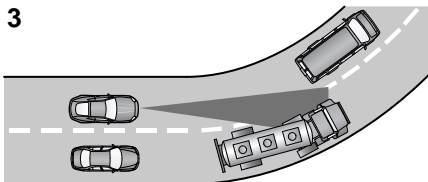

E91498

Detection issues can occur:

1. When driving on a different line to the vehicle in front.
2. With vehicles that edge into your lane. They can only be detected once they have moved fully into your lane.
3. On bends in the road. There may be issues with the detection of vehicles in front, when going into and coming out of a bend.

CAUTION



In these cases, ACC may brake late or unexpectedly. The driver should stay alert and intervene if necessary.

Adaptive cruise control (ACC)

ACC malfunction

If a malfunction occurs during operation of the system in cruise or follow modes, the ACC system will switch off and cannot be used until the fault is cleared. The message **DRIVER INTERVENE** appears briefly, and is then replaced by the message **CRUISE NOT AVAILABLE**. If malfunction of the ACC, or any related system, occurs at any other time, the message **CRUISE NOT AVAILABLE** will be displayed. It will not be possible to activate the ACC system in any mode.

Accumulations of dirt, snow or ice on the radar or cover, may inhibit ACC operation. Fitting of a vehicle front protector, applying stone chip protection or fitting metallised badges, may also affect ACC operation.

The ACC system relies on its radar to detect objects and constantly scans ahead. If the radar detects no objects ahead in ACC or follow mode, then the ACC will be deactivated, the audible alarm sounds and the message **DRIVER INTERVENE** displays briefly. The message **ACC SENSOR BLOCKED** will then be displayed.

The same messages may also be displayed while driving on open roads with few roadside objects for the radar to detect or in heavy rain.

Clearing the obstruction allows the system to return to normal operation. If the obstruction is present when ACC is inactive, e.g. on initial starting or with the ACC system switched off, the message **ACC SENSOR BLOCKED** will be displayed.

Tyres other than those recommended may have different sizes. This can affect the correct operation of the ACC.

Adverse weather conditions

WARNING



Do not use in poor visibility, specifically fog, heavy rain, spray or snow.



Do not use on icy or slippery roads.

During adverse weather conditions such as heavy rain or snowfall, the sensitivity of radar blockage detection is increased, so that it can correctly detect any reduced performance caused by a blocked sensor.

During these conditions, the warning message **ACC SENSOR BLOCKED** may be displayed more frequently, especially in areas where there are few roadside objects for the radar to detect.

Adaptive cruise control (ACC)

FORWARD ALERT FUNCTION



JAG1377

This Forward Alert feature may be switched on or off using the Forward Alert switch in the lower outboard knee bolster switchpack.



When this indicator in the message centre is on, Forward Alert is active.

The sensitivity of the warning may be changed:

- Press the gap decrease button when ACC is disengaged to display and then decrease the sensitivity of the alert.
- Press the gap increase button to display and then increase the sensitivity of the alert.

Both of these alerts are accompanied by the message **FORWARD ALERT** in the message centre.

Limited detection and warning of objects ahead is provided during ACC operation by the ACC **FORWARD ALERT** warning.

The enhanced Forward Alert feature additionally provides warnings whilst ACC is not engaged; if an object is detected close ahead, then the warning tone and message will be issued. The brakes will not be applied. The Forward Alert system does not initiate any action, the driver must take appropriate action when the **FORWARD ALERT** message is displayed. However, the system monitors driver actions (e.g. braking, steering or indicating) and may not initiate the warning display if the appropriate action has been taken early enough.

Adaptive cruise control (ACC)

Message centre information messages

Message	Warning Indicator	Priority Indicator	Meaning
CRUISE OVERRIDE	None	None	Driver is pressing the accelerator pedal, overriding cruise control function. Message will disappear when accelerator pedal is released and cruise control speed is resumed.
CRUISE CANCELLED	None	None	Driver has cancelled cruise control or is braking.
CRUISE NOT AVAILABLE	None	Amber	Cruise control or Adaptive Cruise Control malfunction.
DRIVER INTERVENE	None	Red	Action by the driver to apply the brakes is required.
SETSPEED XXX KM/H	None	None	Speed set for Adaptive Cruise Control.
GAP	None	None	Set the distance (time gap).
RADAR SENSOR BLOCKED	None	Amber	Clean the front of the vehicle in the area of the radar unit (the radar is mounted centrally behind the bumper cover above the grille). This message may also appear under the following conditions: - If stone chip protection has been applied. - On rural roads with few roadside objects. - In heavy rain. - In snowy conditions.
FORWARD ALERT OFF	None	None	Forward alert feature has been switched off. WARNING: A warning will not be given for objects detected in the vehicle's path of travel.
FORWARD ALERT	Yes	None	Forward Alert feature has been switched on or the setting changed. A warning will be given for objects detected in the vehicle path of travel. A longer gap indicates that the system will warn when detected objects are further away than the previous setting.

Automatic speed limiter (ASL)

PRINCIPLE OF OPERATION

WARNING



Automatic Speed Limiter (ASL) set speeds, must be within local speed restriction limits. The driver must always ensure that a safe speed is set, taking into account the prevailing traffic and road conditions.



In certain conditions, such as a steep downhill gradient, the vehicle speed may exceed the set speed limit. This is because engine braking is unable to maintain or reduce the vehicle speed. Driver intervention may be required.

ASL can be used in a situation where varying vehicle speed is likely but a maximum speed must not be exceeded. For example, where a local speed limit is 80km/h (50mph), the set speed could be at that limit or just under.

If ASL is not selected, cruise control is always available by simply rotating the thumb wheel on the right-hand side of the steering wheel to set a cruising speed. See **USING CRUISE CONTROL** (page 148). The **ASL** button allows the driver to select between cruise control and the automatic speed limiter. The ASL can be set to any speed between 30km/h (18mph) and 240 km/h (150 mph).

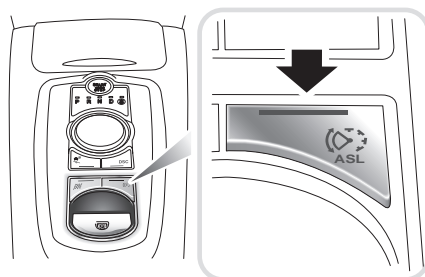

JAG1378



When ASL is selected, the instrument panel telltale status lamp will illuminate. When the ASL button is pressed again, the light will extinguish, ASL will be cancelled and cruise control will be available again.

Note: When the ignition is switched off, ASL is deactivated and any set speed is deleted from memory.

Automatic speed limiter (ASL)

USING THE ASL

Setting a speed limit

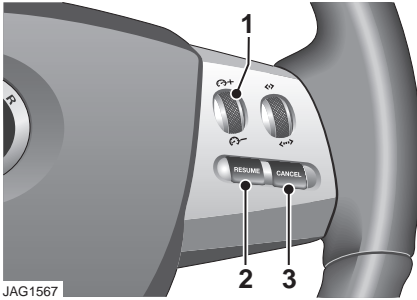

- Press the **ASL** button.
- Use the speed adjustment control (1) to set the required speed.
Rotate the speed adjustment control upwards (+) to increase, or downwards (-) to decrease the set speed, until the desired speed is obtained.
- The set speed can be adjusted at any time, by rotating the speed adjustment control.

LIMITER SET
XXX km/h (MPH)

While a speed is being set or altered, the message centre display in the instrument panel will show the selected speed.

Note: *The message is also displayed at other times as an information display.*

When ASL is selected and a set speed inserted, the engine will respond normally up to the set speed. Further accelerator pedal pressure will not increase the vehicle speed beyond your set speed.

Suspending ASL

Press the **CANCEL** button (3), to suspend ASL operation. Applying sudden, rapid acceleration (kickdown) will also suspend ASL. The following message will be displayed in the message centre.

LIMITER CANCELLED

Resuming ASL

If ASL has been suspended, it can be reinstated with a single press of the **RESUME** button (2). However, ASL will only reinstate if the vehicle speed is less than the current speed set in memory and greater than 30km/h (18mph). The message centre will display an appropriate message if the vehicle speed is too fast to resume ASL.

TOO FAST TO RESUME

Automatic speed limiter (ASL)

Exceeding the set speed

If the set speed is exceeded, e.g. on a steep downhill section, the message centre will display an appropriate message along with an amber warning indicator.

OVER LIMIT XXX km/h (MPH)

There are three categories of over limit displays:

- If the set speed is exceeded by up to 15km/h (9mph), the message centre will display the message along with an amber warning indicator.
- If the set speed is exceeded by more than 15km/h (9mph), the message centre will display the message along with a flashing amber warning indicator.
- If the set speed is exceeded by more than 15km/h (9mph) for a duration of five seconds, the message centre will display the message along with a flashing amber warning indicator and also give an audible warning tone.

Use your brakes to rectify the situation.

ASL unavailable

If ASL is not available due to a fault, the message centre will display an appropriate message, along with an amber warning indicator.

LIMITER NOT AVAILABLE

The message and warning indicator will display continuously while ASL is selected.

When the ignition is switched off, ASL is deactivated and any set speed is deleted from memory.

Driving dynamics

GENERAL INFORMATION

WARNING



It remains the driver's responsibility to drive safely, according to the prevailing conditions and within the law.

JaguarDrive Control

JaguarDrive Control is a selectable vehicle optimisation system, designed to fine-tune the driving characteristics of the vehicle by accommodating different driving conditions or driving styles.

The system allows the performance envelope of the vehicle to be stretched and prevents the necessity for a single, compromised configuration for all conditions, thereby increasing the vehicle's abilities.

The vehicle systems optimised by JaguarDrive Control are:

- Engine management.
- Transmission management.
- Dynamic Stability Control and traction control.
- Adaptive dynamics.
- Active Differential Control (E-diff) - Supercharged vehicles only.

Note: *Changing from one special mode to another, will introduce noticeably different vehicle responses. For example, the engine revs produced by the accelerator position when a special mode is not selected, may increase or decrease when a mode is selected.*

Note: *For naturally aspirated engines, maximum engine speed is limited to 5 000 rev/min when oil temperature is below 20°C (68°F).*

To familiarise yourself with, and get the best from, the JaguarDrive Control modes, you should try out the modes in circumstances which are safe for you and other road users.

WINTER MODE

The Winter mode switch is located to the rear of the JaguarDrive transmission selector, on the centre console.



Press to operate. Designed for use in slippery conditions, when active, Winter mode selects 2nd gear for driving away on level ground (no incline), softens the responsiveness of the engine and modifies the gear change strategy. This ensures that optimum traction is maintained.

Winter mode optimises stability of the vehicle to suit slippery conditions, when grip is reduced. The vehicle performs in a more gentle and controlled manner, to avoid skidding, allowing more confident progress under adverse conditions.

If conditions result in reduced traction being perceived, use of TracDSC may improve progress, provided that the correct tyres for the conditions are fitted. See **STABILITY CONTROL** (page 162). See **USING SNOW CHAINS** (page 218). See **USING WINTER TYRES** (page 205).

Note: *Winter mode cannot be active at the same time as Dynamic mode. Winter mode will remain selected indefinitely after the ignition is switched off, until deselected by the driver.*

Driving dynamics

DYNAMIC MODE

The Dynamic mode switch is located to the rear of the JaguarDrive transmission selector, on the centre console.



Press to operate. Dynamic mode co-ordinates the vehicle's control systems to deliver a high performance driving experience. This setting enhances key vehicle systems so that the vehicle's full potential can be exploited. The vehicle's responses are aimed at involving the driver more in focused and purposeful driving, helping swift progress.

Note: When the transmission is set to permanent manual mode (i.e. using the paddles to change gear while in Sport mode) and Dynamic mode is selected, transmission upshifts are fully controlled by the driver. This means that the transmission will not change up a gear automatically, even when the vehicle's rev limit is reached. When the rev limit is reached, the gear position indicator in the message centre will glow amber, to indicate that the next gear should be selected.

Note: Dynamic mode cannot be active at the same time as Winter mode. Dynamic mode will remain selected for approximately six hours after the ignition is switched off, after which point it will need to be reselected if required.

STABILITY CONTROL

Dynamic Stability Control (DSC)

WARNING



The fact that the vehicle is fitted with DSC, must never allow the driver to be tempted into taking risks which could affect his or her safety or that of other road users. In all cases, it remains the driver's responsibility to drive safely according to the prevailing conditions.

Dynamic Stability Control (DSC) is operational whenever the engine is running, unless it has been manually switched off. When the system is operating, the warning indicator in the instrument panel will flash.

The DSC system controls the Anti-lock Braking System (ABS), traction control and yaw control of the vehicle.

The DSC system assists the driver in retaining directional control of the vehicle in situations where the vehicle is sliding (understeer or oversteer). It must not encourage the driver to drive beyond the limit of adhesion or at speeds higher than those suitable for the prevailing road and traffic conditions.

DSC applies braking pressure to individual wheels if excessive variation is detected. This ensures that the vehicle follows the driver's intended direction of travel as closely as possible.

Traction control will intervene to control wheel spin by automatically reducing the power output from the engine and applying braking to individual wheels. This improves acceleration, particularly on surfaces with uneven friction (e.g. one wheel on ice with another on tarmac).

Note: For recommended DSC mode selection, refer to the JaguarDrive Control scenarios section, in this handbook.

Driving dynamics

TracDSC

WARNING



Vehicle safety may be reduced by inappropriate use of TracDSC. TracDSC should only be used when necessary for the prevailing conditions.

TracDSC optimises the DSC settings for maximum traction in difficult conditions, such as packed snow. This can make greater traction available, without losing all the benefits of DSC. However, vehicle stability may be reduced. The less restrictive settings of TracDSC also enable a more involving and focused driving experience, helping swift progress.

Conditions where the use of TracDSC would be advantageous or necessary:

- To help maintain the movement of the vehicle on soft or loose surfaces (e.g gravel or sand).
- To maximise driver involvement, where it is safe to do so and where conditions permit.

Switching between DSC and Trac DSC

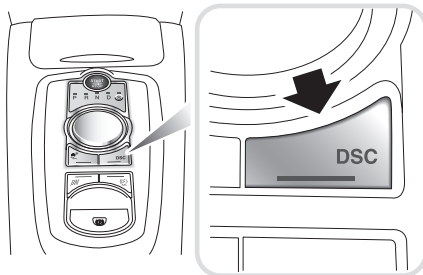

JAG1379

- Press and hold the DSC switch for less than 10 seconds.
- The message centre will temporarily display either **Trac DSC** or **DSC ON**.
- The warning indicator in the instrument panel will illuminate while Trac DSC is selected.
- The warning indicator will flash when DSC or Trac DSC is active.

Note: If cruise control is engaged, it will automatically disengage if stability control activates.

Driving dynamics

Switching between DSC OFF and ON

Switching DSC OFF

- Press and hold the DSC switch for more than 10 seconds.
- The message centre will display **DSC OFF** and a short warning chime will sound.
- The warning indicator in the instrument panel will illuminate.

Switching DSC ON

If DSC is OFF:

- Press and release the DSC switch.
- The DSC system will switch on, the message centre will temporarily display **DSC ON**.
- The warning indicator in the instrument panel will be extinguished.

Note: *Switching the engine off and then on again, will always revert DSC status to DSC ON, regardless of which JaguarDrive Control mode is selected.*

Note: *In rare circumstances, when TracDSC is selected or DSC is off, high acceleration on rough roads may cause the DSC to switch back on. This prevents high loads on the vehicle driveline. DSC will subsequently remain on, unless TracDSC is selected or DSC is switched off manually.*

Stability control indicator



If there is a fault, the warning indicator will illuminate in the instrument panel and the message centre will display **DSC NOT AVAILABLE** with an amber backlight.

It is safe to drive the vehicle, but the DSC system will not activate under wheel spin or slide conditions. You should seek qualified assistance as soon as possible.

Adaptive dynamics

Jaguar Adaptive dynamics continuously monitors the road and driver inputs and optimises the vehicle suspension settings for ride comfort and control.

The adaptive dynamics system is linked to Dynamic mode, modifying the suspension settings for a more sporting character.

If the message centre displays the message **ADAPTIVE DYNAMICS FAULT**, a fault has been detected in the adaptive dynamics system. Seek qualified assistance as soon as possible.

Active Differential Control (E-diff) (Supercharged vehicles only)

The E-diff improves traction when one driven wheel has more grip than the other. This improves progress out of corners and on patchy or uneven surfaces. The E-diff can also increase stability in oversteer situations, depending on road conditions and driver inputs.

Settings for the E-diff are made automatically, without the need for driver selection.

If there is a fault with the E-diff system, the message centre will display **EDIFF SYSTEM FAULT**. If DSC is off, then TracDSC will be selected automatically. The driver can still switch between DSC modes as normal and the vehicle is safe to drive, but seek qualified assistance as soon as possible.

Note: *If the E-diff is active continuously for an extended period (e.g. on a patchy surface with DSC off), then the E-diff may be temporarily deactivated to prevent overheating. If DSC is off, then TracDSC will be selected automatically. The message centre will display **EDIFF NOT AVAILABLE**. The driver can still switch between DSC modes as normal and the E-diff will become available again automatically when it has cooled sufficiently.*

Driving dynamics

JaguarDrive Control scenarios

The table below gives examples of the drive control settings suggested for different driving scenarios.

Scenario	Suggested driver selection			
	Tyre fitment	JaguarDrive Control	Dynamic Stability Control (DSC)	Transmission
Wet grass	Standard	Winter mode	DSC On (default)	Drive (D)
Very wet tarmac				
Ice/light snow	Standard or All Season tyres			
Snow ploughed hard-topped roads (including black ice)	All Season tyres			
Packed snow roads	Winter tyres			
Deep fresh snow	Snow chains	No driver selection required. Special modes off.		Sport (S)
Normal driving conditions (e.g. dry tarmac, town driving, motorway cruising etc.)	Standard			Drive (D)
Overtaking on a dry road				Drive (D) or Sport (S)
Pulling out onto a busy road in dry conditions				
Favourite country lane (public road)				
Private track/race day	TracDSC (where conditions permit)			

Fuel and refuelling

SAFETY PRECAUTIONS

WARNINGS



Petroleum gasses are highly flammable, have a low flash point and are explosive, especially in confined spaces. Avoid exposing the gasses to any potential sources of ignition, as the resulting fire and explosion may cause serious injuries and/or death.



Only use containers specifically designed for carrying fuel, and always remove them from the vehicle to fill them. Failure to do so may result in spillage and cause a fire.



Switch off the engine when refuelling, as it is both a source of extreme temperatures and electrical sparks. The resulting fire and explosion may cause serious injury and death.



Switch off any personal electronic devices such as mobile phones, or music players. They have the potential to cause electrical sparks. The resulting fire and explosion may cause serious injury and death.



Do not smoke, use a naked flame, or cause sparks. The resulting fire and explosion may cause serious injury and death.



Do not overfill the fuel tank. Overfilling may cause spillage when the vehicle is driven. Spillage may also occur if the fuel expands in high ambient temperatures.

WARNINGS



The presence of any unusual fumes (for example, petrol or exhaust fumes) in the passenger compartment and/or luggage compartment should be corrected immediately by a Jaguar Dealer/Authorised Repairer. If you must drive under these conditions do so only with all windows fully open.



Any modifications to the fuel system not specifically designed for this Jaguar are prohibited. Such modifications in some circumstances could result in a fire. All service actions should be entrusted to a Jaguar Dealer/Authorised Repairer.

FUEL QUALITY

CAUTIONS



Do not use leaded fuels, lead substitutes or fuel additives. Doing so can cause damage to the engine, fuel and emission control systems.



Only use high quality petrol, as using lower quality fuels can cause damage to the engine, fuel and emission control systems.



Fuel system cleaning agents should not be used, unless approved by Jaguar. Unapproved products may be harmful to fuel system components on your vehicle.



It is the driver's responsibility to fill the vehicle with the correct fuel. If the vehicle is filled with the wrong type of fuel, **do not** start the engine. Call for Roadside Assistance.

Fuel and refuelling

Unleaded fuel

Unleaded fuel must be used for the emission control system to operate properly. Its use will also reduce spark plug fouling, exhaust system corrosion and engine oil deterioration.

Octane rating

The recommended unleaded fuel should have an octane rating of 95 RON (Research Octane Number) or higher. However, you may also use unleaded fuel with a lower RON, but performance will be reduced. The minimum octane rating for fuel to be used is 91 RON.

Note: *Using unleaded fuel with a lower octane rating than recommended, can cause persistent heavy engine knock (a metallic rapping noise). If severe, this can lead to engine damage.*

If a heavy knock is detected, even when using fuel to the recommended octane rating, or if you hear knock while holding a steady speed on level roads, consult your Dealer/Authorised Repairer to have the problem corrected. Failure to do so is misuse of the vehicle, for which Jaguar Cars is not responsible. However, occasional, light knock for a short time while accelerating or driving up hill, may occur.

ALTERNATIVE FUELS

Fuels containing alcohol

CAUTION



-  Fuel containing alcohol can cause paint damage, which may not be covered under the warranty.

Some fuel suppliers sell fuel containing alcohol without advertising its presence. Where uncertainty exists, check with the service station operator.

Note: *Some difficulty in starting may be encountered when using alcohol blended fuel.*

Ethanol

CAUTIONS

-  This vehicle is not suitable for use with fuels containing more than 10% Ethanol.
-  Do not use E85 fuels (85% Ethanol content). Equipment necessary for the use of fuels containing more than 10% Ethanol is not fitted to this vehicle. If E85 fuels are used, serious engine and fuel system damage will occur.

Fuels containing up to 10% Ethanol (grain alcohol) may be used. Ensure that the fuel has octane ratings no lower than those recommended for unleaded fuel. Most drivers will not notice any operating difference with fuel containing Ethanol. If a difference is detected, the use of conventional unleaded fuel should be resumed.

Methanol

CAUTION

-  Wherever possible, avoid using fuel containing Methanol.

Some fuels contain Methanol (Methyl or wood alcohol). If you use fuels containing Methanol the fuels must also contain co-solvents and corrosion inhibitors for Methanol. Also, do not use fuels which contain more than 10% Methanol even if they contain co-solvents and corrosion inhibitors. Fuel system damage or vehicle performance problems resulting from the use of such fuels is not the responsibility of Jaguar, and may not be covered under the warranty.

Fuel and refuelling

Methyl Tertiary Butyl Ether (MTBE)

Unleaded fuel containing an oxygenate known as MTBE can be used provided that the ratio of MTBE to conventional fuel does not exceed 15%. MTBE is an Ether based compound derived from Petroleum, which has been specified by several refiners as the substance to enhance the Octane rating of fuel.

Reformulated gasoline

Several petroleum companies have announced the availability of reformulated fuels. These fuels are specially formulated to further reduce vehicle emissions. Jaguar fully supports all efforts to protect and maintain ambient air quality and encourages the use of reformulated gasoline where available.

RUNNING OUT OF FUEL

CAUTIONS

- ⚠ Avoid running out of fuel. Doing so can cause damage to the vehicle's engine, fuel and emission control systems.
- ⚠ Do not run the fuel tank dry. Running the fuel tank dry could create an engine misfire.

Note: If the vehicle does run out of fuel, a minimum of 4 litres (0.9 gallons) will be required to restart the engine. The vehicle will need to be driven 1.6-5 km (1-3 miles) in order to reset the engine management and monitoring systems.

Note: If the vehicle does run out of fuel, seeking qualified assistance is advisable.

FUEL FILLER FLAP

WARNINGS

- ⚠ Open the fuel filler cap slowly and allow the pressure to release before fully removing the cap, to avoid fuel spillage due to rapid expansion.
- ⚠ Take note of all warnings and instructions given on the label affixed to the inside of the filler flap.



The fuel filler flap release switch is located in the knee bolster switchpack below the facia. The switch is inhibited if the vehicle is armed. The filler flap is on the right-hand side of the vehicle.

A label on the inside of the fuel filler flap serves as a reminder to fill the tank with the correct fuel.

Fuel and refuelling

REFUELLING

Fuel filling

WARNINGS



Do not fully remove the fuel filler cap until any captive tank pressure has been released (wait until the hissing stops).



When refuelling ensure that all windows, doors, and sunroof are fully closed, particularly if young children or animals are in the vehicle. Fuel vapour contains harmful chemical compounds, some of which may cause cancer.



Do not attempt to fill the tank to its maximum capacity. If the vehicle is to be parked on a slope, in direct sunlight or high ambient temperature, expansion of the fuel could cause spillage. Filling station pumps are equipped with automatic cut-off sensing, to avoid fuel spillage. Fill the tank until the filler nozzle automatically cuts-off the supply. Do not attempt to fill the tank beyond this point.

CAUTIONS



Ensure that you check the fuel pump information carefully, to ensure that you are putting the correct fuel into the vehicle. Filling a vehicle with the incorrect fuel can cause serious engine and fuel system damage.



It is the driver's responsibility to fill the vehicle with the correct fuel. If the vehicle is filled with the wrong type of fuel, **do not** start the engine. Call for Roadside Assistance.

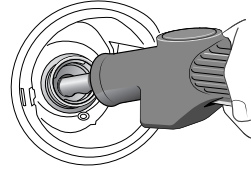
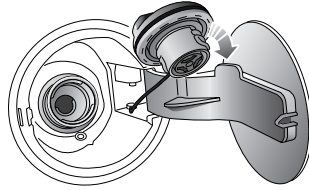

E91581

To remove the filler cap, turn it counterclockwise approximately a $\frac{1}{4}$ turn, until a slight resistance is met. Continue turning to release it. Remove the cap from the filler neck.

The cap is held by a retaining strap and can be stowed on the filler flap hook.

The filler neck of the fuel tank is a small diameter to suit only unleaded fuel pump dispenser nozzles.

Insert the dispenser nozzle into the filler neck sufficiently to open the trap door, for fuel to flow into the fuel tank. Fill the tank until the filler nozzle automatically shuts off. Filling beyond this point could result in fuel spillage.

After refuelling, refit the filler cap. Twist the cap clockwise until it clicks at least three times. Close the flap, which automatically locks.

System fault display

The message centre will display the message **FUEL PUMP SYSTEM FAULT**, when a fault is detected in the fuel system. The total fuel capacity may not be available to be used. Seek qualified assistance as soon as possible.

If the message **CHECK FUEL FILLER CAP** is displayed, check that the cap is correctly closed.

Fuel and refuelling

FUEL TANK CAPACITY

Avoid the risk of running out of fuel and never intentionally drive the vehicle when the fuel gauge indicates that the tank is empty. When refuelling your vehicle after the fuel gauge reads empty, you may not be able to add the fuel quantity shown below, as there will be a small reserve remaining in the tank.

Total tank capacity	71.1 litres (15.6 gallons)
Fill capacity (when the fuel gauge indicates empty)	65.1 litres (14.3 gallons)
Reserve capacity (when the fuel gauge indicates empty)	6.0 litres (1.3 gallons)

Fuel specification	
Minimum	91 RON
Recommended	95 - 98 RON

Fuel and refuelling

FUEL CONSUMPTION

The fuel consumption figures shown below have been calculated using a standard testing procedure (the new EC test procedure from Directive 99/100/EC), and produced in accordance with The Passenger Car Fuel Consumption (Amendment) Order 1996.

Under normal use, a vehicle's actual fuel consumption figures may differ from those achieved through the test procedure, depending on driving technique, road and traffic conditions, environmental factors, vehicle load and condition.

Variant	Urban l/100 km (mpg)	Extra-urban l/100 km (mpg)	Combined l/100 km (mpg)	CO² emissions g/km
5.0 V8 Petrol - Normally aspirated	17.1 (16.5)	8.0 (35.3)	11.2 (25.2)	264
5.0 V8 Petrol - Supercharged	18.9 (14.9)	8.6 (33.0)	12.3 (23.0)	292

Urban cycle

The urban test cycle is carried out from a cold start and consists of a series of accelerations, decelerations and periods of steady speed driving and engine idling. The maximum speed attained during the test is 50 km/h (30 mph) with an average speed of 19 km/h (12 mph).

Extra-urban cycle

The extra-urban test cycle is carried out immediately after the urban test. Approximately half of the test comprises steady-speed driving, while the remainder consists of a series of accelerations, decelerations and engine idling. The maximum test speed is 120 km/h (75 mph) and the average speed 63 km/h (39 mph). The test is carried out over a distance of 7 km (4.3 miles).

Combined

The combined figure is an average of the urban and extra-urban test cycle results, which has been weighted to take account of the different distances covered during the two tests.



For additional information on fuel consumption figures and exhaust emissions, visit the Vehicle Certification Agency (VCA) website at <http://www.vcacarfueldata.org.uk/>.



Load carrying

GENERAL INFORMATION

WARNINGS

-  (Coupe only): Extreme care must be taken when closing the luggage compartment lid when passengers are travelling in the rear seats.
-  Locate heavy loads in the luggage compartment towards the front of the vehicle and secure them to stop them sliding. Loose items can be a hazard.
-  Do not drive with the luggage compartment open as exhaust fumes can be drawn into the passenger compartment.

To prevent permanent damage to the luggage compartment trim, it is advisable to distribute luggage weight evenly over the entire luggage floor area.

LUGGAGE COVERS (Coupe only)

CAUTION

-  It is advisable that items are not placed on the luggage cover.

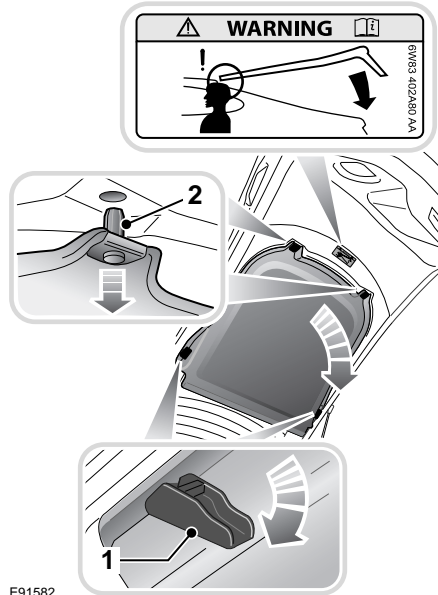

E91582

The luggage cover is removed by releasing the two latches (1) on either side of the luggage cover and sliding the cover downwards and forwards, so that the rear locating pegs (2) are disengaged from the trim and body. This will allow the luggage cover to be completely removed.

To refit the luggage cover first locate the rear pegs (2). Then, from the side of the vehicle, support the luggage cover and fit the front catch (1), by pressing it firmly through the cover and closing the catch. This will hold the luggage cover in place. Repeat this procedure on the other side of the vehicle.

Vehicle care

CLEANING PRODUCTS

WARNINGS



Many liquids and other substances used in vehicles are poisonous and should never be consumed and must be kept away from open wounds. These substances include antifreeze, brake fluid, fuel, windscreen washer additives, lubricants and various adhesives.



Dry cleaning fluids may be toxic or flammable. Take adequate precautions when handling these products.

CAUTION



Read individual product warnings before using any vehicle cleaning or washing products.

Brush and clean the interior regularly. Use a vacuum cleaner where possible to remove all dust from the interior and trim.

CLEANING THE EXTERIOR

CAUTIONS



Some high pressure cleaning systems are sufficiently powerful to penetrate door and window seals, and damage trim and door locks. Never aim the water jet directly at the engine air intake, heater air intakes, body seals (doors, sunroof, windows etc.) or at any components which may be damaged (lamps, mirrors, exterior trim etc.).



Ensure that you read and comply with all warnings and instructions supplied with any cleaning products.



Never use cleaning products which are not approved for use on vehicles.



E91586

Washing the vehicle

CAUTION



Substances which are corrosive, such as bird droppings, tree resin, dead insects, tar spots, road salt and industrial fall out, can damage the vehicle's paintwork. Any such deposits should be removed as soon as possible, to prevent damage to the vehicle's paintwork.

Remove heavy deposits of mud and dirt with a hose, before washing the vehicle.

When salt is used on the roads, wash the vehicle immediately after encountering such conditions. Clean undersides and wheel arches using a high pressure jet.

Wash the vehicle frequently. Do not use a dry cloth to wipe dirty paintwork. Dust and gritty substances are abrasive and will scratch the paintwork. Remove dirt using a cellulose sponge and generous quantities of cold or luke warm (never hot) water containing a suitable car shampoo. Rinse thoroughly with clean water and dry with a clean, damp chamois leather or synthetic substitute.

For best results, do not wash the vehicle under strong sunlight. Always allow the vehicle to cool down before washing.

Vehicle care

Do not use household soaps or detergents. The use of Jaguar Vehicle Shampoo is recommended.

Using an automatic wash

CAUTION

- ⚠ Ensure that AUTO wipe is not selected when entering a car wash or damage to the wiper blades and arms can occur as they will operate in the car wash.

Note: Regular use of automatic car washes tends to dull the lustre of the paintwork.

After leaving the car wash, switch on the windscreen wiper immediately, to remove water and prevent a build up of wax.

Convertible top fabric

CAUTIONS

- ⚠ Do not use an automatic car wash that has rotating brushes. The action of the brushes may damage the exterior fabric or the seals of the convertible top.
- ⚠ Do not use spot cleaners, chemical dilutants or any organic cleaners. If in doubt, contact your Jaguar Dealer/Authorised Repairer.

To maintain the appearance and condition of the convertible top, the recommendations given below should be followed. This is of particular importance in the case of light coloured tops.

Do not leave the top in the open (folded) position for longer than is necessary, as in certain circumstances permanent soiling along the folds may occur.

Cleaning: Every 1 600 km (1 000 miles) vacuum clean and wash the convertible top using the Jaguar Soft Top Cleaning Kit, carefully following the instructions enclosed.

Reproofing: Every 8 000 km (5 000 miles) reproof the top using the solution in the cleaning kit, carefully following the instructions enclosed.

Underbonnet cleaning

CAUTION

- ⚠ Do not use a high pressure washer or steam cleaner in the engine compartment. Damage to components could occur.

Preparation for winter

Before the onset of winter, it is advisable to coat the convertible top seals and respective body seals with a compound, such as Carbaflo KSP 105, to aid operation in freezing conditions. This action will need to be repeated at the start of each winter to maintain protection.

Care must be taken so that the compound does not come into contact with the convertible top material. For further advise you should contact your Jaguar Dealer/Authorised Repairer.

Vehicle care

Glass surfaces

Clean the rear window with a soft cloth to avoid damaging the heating element. Do not scrape the glass or use any abrasive cleaning fluid.

Mirror glass is particularly susceptible to damage. Wash with soapy water. Do not use abrasive cleaning compounds or metal scrapers to remove ice.

The following products will ensure glass surfaces and windscreen wipers are kept in good condition:

Jaguar Screen Clean Paste: Apply to the exterior of the windscreen only to ensure effective operation of the windscreen wiper.

Jaguar Glass Cleaner: Interior and exterior of all other glass surfaces.

Jaguar Screen Wash: Washer reservoir additive.

Jaguar Winter Care Kit: Comprising de-icer, ice scraper and anti-mist wipe cloth.

Cleaning the rear screen

To avoid damaging the heating and radio elements (coupe only), when cleaning the inside of the rear screen use only a soft damp cloth or chamois leather. Do not use solvents or sharp objects to clean the glass.

Removing grease and tar

Remove grease or tar with Jaguar Tar Remover or methylated spirit (alcohol). White spirit is also effective, but must not be applied to rubber, particularly the windscreen wiper blades.

Bird droppings

Do not allow bird droppings or tree sap to harden. Remove from paintwork immediately with a lukewarm soap and water solution.

Polishing

For maximum protection against road dust, salts, industrial fall-out etc., it is recommended that the vehicle is polished regularly using Jaguar polish and a polishing cloth.

Note: *The vehicle's brightwork should be cleaned in the same way as the paintwork: Chrome polish or other abrasive cleaners must not be used.*

CLEANING ALLOY WHEELS

CAUTION



Do not use non-approved, or acid based wheel cleaners. These can damage the wheel coating which may lead to corrosion of the wheel rims.

The alloy road wheels are covered with a protective anti-corrosion coating. To prevent corrosion, it is essential that this coating is not damaged.

When removing or fitting tyres, always advise the tyre fitter to treat the alloy wheels with great care. Tyre levers must not be used.

Wash the wheels regularly with soap and water, to avoid an accumulation of particles. In salty conditions, the wheels should be cleaned more frequently.

Jaguar acid-free wheel cleaner can be used to remove heavy soiling.

REPAIRING MINOR PAINT DAMAGE

Regularly inspect the paintwork for damage. Inspect the paintwork immediately after the vehicle has been washed. Any stone chips, fractures or deep scratches in the paint or bodywork, should be repaired promptly. Bare metal will corrode quickly and if left untreated, can result in expensive repairs.

Vehicle care

Minor chips and scratches can be touched up using materials and advice available from a Jaguar Dealer/Authorised Repairer. Larger areas of damage will require professional repair and you should consult a Jaguar Dealer/Authorised Repairer.

CLEANING THE INTERIOR

WARNING



Ensure that you read all of the information and instructions for use provided with cleaning products.

Some products contain substances that are harmful and can cause health problems if used incorrectly.

CAUTIONS



Some products, if used incorrectly can cause damage to the interior surfaces of the vehicle.



To prevent airbag damage, the steering wheel centre pad and other areas containing airbags should only be cleaned sparingly with a damp cloth, warm water and a non-detergent soap. Do not allow these areas to be flooded with chemical solvents, liquids, furniture cream or polishes.

Leather

Leather is easy to maintain, however, dust and substances can penetrate the pores and crease the leather, causing surface wear and brittleness.

To prevent ingrained dirt and staining, inspect the seat upholstery regularly and clean every one to two months as follows:

- Wipe off fine dust from the seat surfaces using a clean, damp, non-coloured cloth. Change frequently to a clean area of cloth to avoid abrasive action on the leather surface. Avoid over-wetting.

- If this is not sufficient, use a cloth which has been dampened with warm soapy water and then wrung out. Use only mild non-caustic soap.
- Use Jaguar Leather Cleaner for heavily soiled areas. Dry off and rub with a clean soft cloth, changing surfaces regularly.

When staining (e.g. from clothing) or spillage occurs, clean the affected area immediately as described above.

Use Jaguar Leather Cleaner several times a year to maintain its appearance and suppleness. The cleaner will nourish and moisturise and help to improve the surface protective film against dust and substances.

- Do not use solvents. Do not use detergents, furniture polish or household cleaners. While these products may initially give impressive results, their use will lead to rapid deterioration of the leather and will invalidate the warranty. Jaguar recommend a basic set of products that have been specially selected for the type of leather in your vehicle.
- Dark clothing may stain leather seats just like other upholstery products.
- Sharp objects such as belts, zip fasteners, rivets, etc. can leave permanent scratches and scratch marks on the leather surface.
- Unless spillages such as tea, coffee or ink are washed away immediately, permanent staining may have to be accepted.

If a valet service is used, ensure that the specialist concerned is aware of, and follows these instructions precisely.

Vehicle care

Cloth and fabric

CAUTIONS

- ⚠ Never use soap, ammonia, bleach or other cleaners intended for use on hard surfaces.
- ⚠ Do not use upholstery cleaner on electrical equipment, such as facia switches.
- ⚠ When cleaning around electrical equipment such as switches, ensure that fluids do not leak into any gaps around the components or between panels or trim.

Use Jaguar Upholstery Cleaner, following the instructions. Avoid over-wetting.

Removing stains

Most stains on woollen fabric can be removed if treatment is carried out immediately, before the stain has a chance to dry-in.

Most stains can be treated with one of three cleaning fluids: Jaguar Upholstery Cleaner, dry cleaning fluid or clean water. Follow the instructions on the package.

Instrument pack, clock, and audio equipment

Only use a soft dry cloth to clean the instrument pack, clock, and audio equipment. Do not use cleaning fluids or sprays.

Carpet and mats

Marks or stains can be removed by gentle scrubbing, with a weak solution of soap and warm water.

For more stubborn stains, a commercially available carpet cleaner should be used.

Floor mat retention

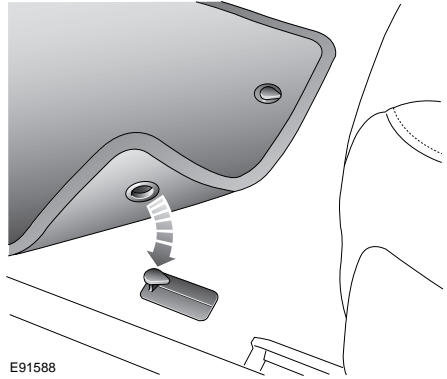

The driver's floor mat must be correctly positioned and secured under the tongues on the retention posts (only one post shown). Ensure that the mat does not interfere with the operation of the accelerator or brake pedal.

Seat belts

WARNING



Do not allow any water, cleaning products or fabric from cloths to enter the seat belt mechanism. Any substance which enters the mechanism, may affect the performance of the seat belt in an impact.

Extend the seat belts fully, then use warm water and a non-detergent soap to clean. Allow the seat belts to dry naturally while fully extended.

Note: When cleaning the seat belt, take the opportunity to examine the webbing for damage and wear. Any wear or damage should be reported to, and rectified by, a Jaguar Dealer/Approved Repairer.

Maintenance

GENERAL INFORMATION

Protect the environment

We must all play our part in protecting the environment. Correct vehicle usage and disposal of waste cleaning and lubrication materials are significant steps towards this aim.

Avoid using high engine speeds. This will protect your engine, reduce fuel consumption, lower the engine noise level and help towards reducing the environmental burden.

Dispose of used parts and fluids at your local authorised waste disposal facilities.

Regular servicing

CAUTION



Severe damage to the electrical system and electronic components can occur, if any attempt is made to diagnose faults in the electrical system using conventional diagnostic equipment (e.g. the use of test lamps or low impedance voltmeters). The fitting of any electrical accessory should only be entrusted to a Jaguar Dealer/Authorised Repairer.

Regular maintenance and servicing is the responsibility of the owner. Failure to implement maintenance at the recommended intervals, could result in deterioration of vehicle performance.

Your Jaguar Dealer/Authorised Repairer will be pleased to arrange periodic servicing in accordance with the Service Portfolio book.

Service Portfolio

The Service Portfolio book includes a Service Record section, which enables a record to be kept of all the servicing and inspections that are carried out on the vehicle. This section of the book also has an area for brake fluid changes to be recorded.

Ensure your service provider signs and stamps the book after each service and inspection.

Owner maintenance

CAUTION



Any significant or sudden drop in fluid levels, or uneven tyre wear, should be reported to a qualified technician without delay.

In addition to the routine services and inspections, a number of simple checks must be carried out more frequently. You can carry out these checks yourself.

Daily checks

- Operation of lamps, horn, direction indicators, wipers, washers and warning indicators.
- Operation of seat belts and brakes.
- Look for fluid deposits underneath the vehicle that might indicate a leak. Condensation drips from the air conditioning is normal.

Maintenance

Weekly checks

CAUTION



Ensure that you take notice of any message centre information and warnings relating to engine oil level. Top-up the level when advised to do so. See **ENGINE OIL CHECK** (page 183).

- Engine coolant check. See **ENGINE COOLANT CHECK** (page 186).
- Brake fluid level. See **BRAKE FLUID CHECK** (page 187).
- Power steering fluid level. See **POWER STEERING FLUID CHECK** (page 189).
- Screen washer fluid level. See **WASHER FLUID CHECK** (page 190).
- Tyre pressures and condition. See **TYRE CARE** (page 199).
- Operate air conditioning. See **Climate control** (page 106).

Monthly

- **Wiper blades:** Check the quality of the wiper. If smearing or juddering is evident, clean the windscreen and renew the wiper blades. See **CHANGING THE WIPER BLADES** (page 82).

Emission control

Your vehicle is fitted with various items of emission and evaporative control equipment, designed to meet specific territorial requirements. You should be aware that unauthorised replacement, modification or tampering with this equipment by an owner or repair shop, may be unlawful and subject to legal penalties.

In addition, engine settings must not be tampered with. These have been established to ensure that your vehicle complies with stringent exhaust emission regulations. Incorrect engine settings may adversely affect exhaust emissions, engine performance and fuel consumption. They may also cause high temperatures, which will result in damage to the catalytic converter and the vehicle.

Road testing dynamometers (rolling roads)

Because your vehicle is equipped with anti-lock brakes, it is essential that any dynamometer testing is carried out only by a qualified person, familiar with the dynamometer testing and safety procedures practised by Jaguar Dealers/Authorised Repairers.

Maintenance

SAFETY IN THE GARAGE

WARNINGS



If the vehicle has been driven recently, do not touch exhaust and cooling system components until the engine has cooled.



Never leave the engine running in an unventilated area - exhaust gases are poisonous and extremely dangerous.



Do not work beneath the vehicle with the wheel changing jack as the only means of support.



Keep your hands and clothing away from drive belts and pulleys.



Remove metal wrist bands and jewellery, before working in the engine compartment.



Do not touch electrical leads or components while the engine is running, or with the starter switch turned on.



Do not allow tools or metal parts of the vehicle to make contact with the battery leads or terminals.

Fuel system

WARNINGS



Under no circumstances should any part of the fuel system be dismantled or replaced by anyone other than a suitably qualified vehicle technician. Failure to comply with this instruction, may result in fuel spillage with a consequent serious risk of fire.



Ensure sparks and naked lights are kept away from the engine compartment.



Wear protective clothing, including, where practicable, gloves made from an impervious material.

Poisonous fluids

Fluids used in motor vehicles are poisonous and should not be consumed or brought into contact with open wounds. These include; battery acid, antifreeze, brake, clutch and power steering fluid, petrol, diesel, engine oil and windscreen washer additives.

For your own safety, always read and obey all instructions printed on labels and containers.

Used engine oil

Prolonged contact with engine oil may cause serious skin disorders, including dermatitis and cancer of the skin. Always wash thoroughly after contact.



It is illegal to pollute drains, water courses or soil. Use authorised waste disposal sites to dispose of used oil and toxic chemicals.

Maintenance

OPENING AND CLOSING THE BONNET

WARNING



When working within the engine compartment, take care to avoid contact with moving parts and hot components.

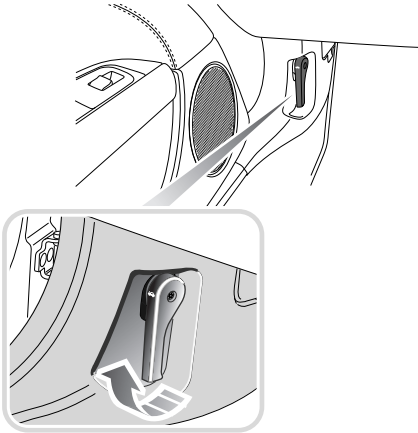

E91596

The bonnet lock release control is below the fascia on the left-hand side of the vehicle.

To open: Release the bonnet lock by pulling the lever. Reach across to the centre rear edge of the bonnet and lift. The gas filled struts will assist raising the bonnet and retain it in the fully open position.

Closing the bonnet

WARNINGS



Before closing the bonnet ensure that no one is obstructing the closing area and that hands and clothes are clear.



Do not drive with the bonnet retained by the safety catch alone.

CAUTION



Do not press downward on the top of the bonnet to close it, especially within the final centimetres (inches) of closing, as this may damage the bonnet.

Close the bonnet to within a distance of 300 to 350 mm (12 to 14 inches) of the fully closed position, then release and allow the bonnet to shut.

To check that the bonnet is closed, pull the bonnet upwards to ensure that both the right-hand and left-hand latches are engaged.

Maintenance

ENGINE COMPARTMENT OVERVIEW

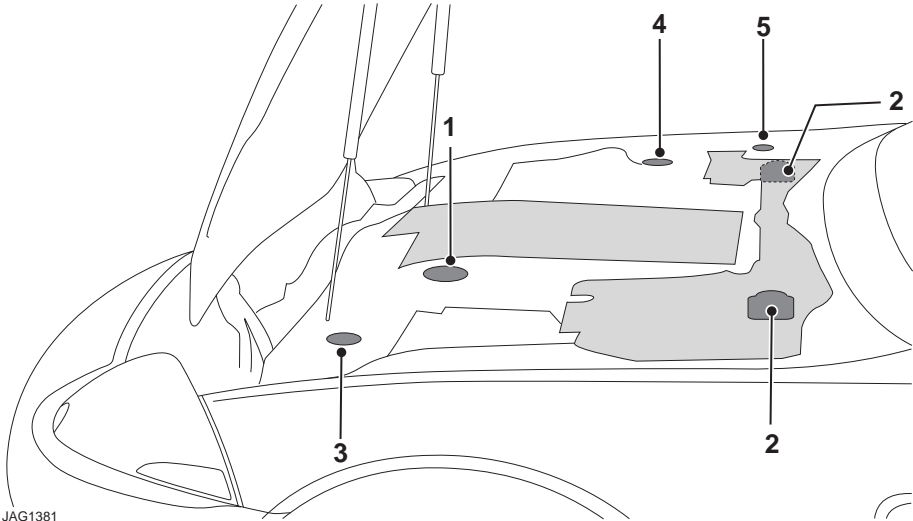

JAG1381

WARNINGS



While working in the engine compartment, always observe the safety precautions listed earlier in this chapter. See **SAFETY IN THE GARAGE** (page 180).



Do not drive the vehicle if there is a possibility that leaked fluid will come into contact with a hot surface, such as the exhaust. A resulting fire may cause death or serious injury.

1. Engine oil filler cap (Black)



JAG1636

2. Brake fluid reservoir cap (Yellow)



E91601

Maintenance

3. Power steering fluid reservoir cap (Black)



E91603

4. Coolant reservoir cap (Black)



JAG1413

5. Washer fluid reservoir cap (Blue)



E91599

ENGINE OIL CHECK

CAUTIONS

! If the warning **ENGINE OIL CRITICALLY LOW** is displayed in the message centre, stop the engine as soon as it is safe to do so and seek qualified assistance. Do not start the engine until the cause has been identified and rectified.

! Your vehicle's warranty may be invalidated if damage is caused by the use of improper engine oil. Low quality or obsolete oils do not provide the protection required by modern, high performance engines. Failure to use an oil that meets the required specification could cause excessive engine wear, a build up of sludge and deposits and increased pollution. It could also lead to engine failure.

! Do not use oil additives of any type as engine damage could occur. Use only specified lubricants.

Engine oil consumption

A certain amount of oil consumption is normal. The rate of consumption will depend on the following:

- The quality and viscosity of the oil.
- Climatic conditions.
- The speed at which the engine is being operated.
- Road conditions.

Drivers should expect above normal consumption when the engine is new.

Maintenance

Oil level warnings

Warnings will be displayed in the message centre if the oil level is not maintained within the safe operating levels (minimum and maximum). A warning will also be displayed if there is a fault with the oil level monitoring system.

- **ENGINE OIL LOW** (amber): The oil is at the minimum level for safe operation. Top-up with 1 litre (1.8 pints) of oil.
- **ENGINE OIL HIGH** (amber): This warning is displayed when the engine is started, if the oil is above the maximum level for safe operation. Seek qualified assistance to have the engine oil drained, before driving the vehicle.
- **ENGINE OIL CRITICALLY LOW** (red): The oil is below the minimum level for safe operation. Stop the vehicle as soon as safety permits and top-up with 1.5 litres (2.6 pints) of oil. Wait for 5 minutes, recheck the oil level reading and top-up again if necessary.
- **ENGINE OIL LEVEL MONITOR SYSTEM FAULT** (amber): A fault with the oil level monitoring system is indicated. Seek qualified assistance as soon as possible.

Checking the oil level

The engine oil level is automatically monitored and is displayed in the trip computer area of the message centre.

The current oil level can be viewed with the ignition on, with the engine stopped, the transmission in Park (P) and the vehicle parked on level ground.

To view the current oil level, press the **TRIP** button on the end of the left column stalk repeatedly, until the oil can icon is displayed at the bottom of the message centre.

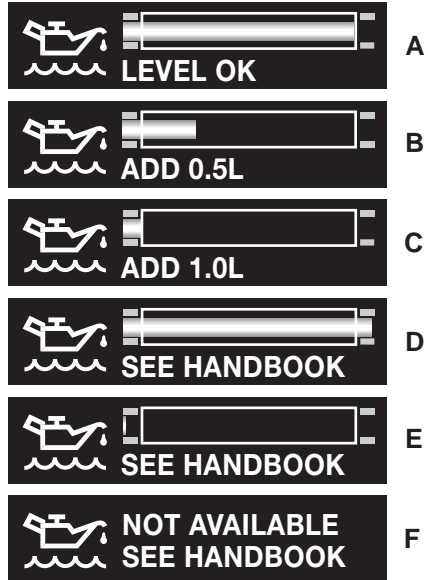

JAG1412

- A.** Oil at recommended level. No top-up required.
- B.** Add 0.5 litres (0.9 pint) of oil.
- C.** Add 1 litre (1.8 pints) of oil.
- D.** Oil level above maximum for safe operation. Do not drive the vehicle. Seek qualified assistance.
- E.** Oil level below minimum for safe operation. Add 1.5 litre (2.6 pints) of oil, then recheck level.
- F1.** Oil level stabilising, oil level not available. Wait ten minutes and then recheck the oil level display.
- F2.** If this display is accompanied by the warning message **ENGINE OIL LEVEL MONITOR SYSTEM FAULT**, a fault with the oil level monitor is indicated. Seek qualified assistance.

Maintenance

Topping up the oil

CAUTIONS

- ❗ Your vehicle warranty may be invalidated if damage is caused by using oil that does not meet the required specification.
- ❗ Failure to use an oil that meets the required specification, could cause excessive engine wear, a build-up of sludge and deposits and increase pollution. It could also lead to engine failure.
- ❗ Overfilling with oil could result in severe engine damage.

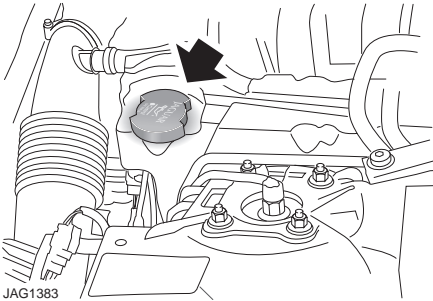

1. With the ignition on, but the engine not running, unscrew the oil filler cap (arrowed).
2. Add the appropriate quantity of oil (as indicated by the message centre oil level display). Wait 5 minutes to let the oil level stabilise and re-check the level.
Clean up any oil spilled during topping up.
3. Once the correct level is achieved, refit the filler cap and hand tighten securely until one click is heard.

Note: The approximate quantity of oil required to raise the level from the minimum level of safe operation to the maximum, is 1.5 litres (2.6 pints).

Note: The ignition must be left on during the top-up, so that the electronic dipstick can register and display the new oil level. This enables an accurate level re-check.

Engine oil specification

It is essential to use the correct specification of engine oil, and to ensure it is suitable for the climatic conditions in which the vehicle is to be operated.

Jaguar recommends:



Use only 5W-20 engine oil, meeting specification WSS M2C925-A.

Maintenance

ENGINE COOLANT CHECK

WARNINGS



The radiator cooling fans may continue to run after the ignition has been switched off, but will automatically switch off when the engine has cooled sufficiently.

CAUTION



Running the engine without coolant will cause serious engine damage.



If persistent coolant loss is noticed, seek qualified assistance immediately.

The coolant level in the expansion tank should be checked at least weekly (more frequently in high mileage or severe operating conditions). Always check the level when the system is cold.

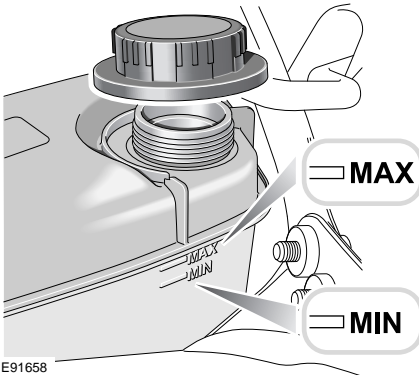

Ensure the coolant level is maintained between the **MAX** and **MIN** level indicators, located on the side of the expansion tank.

If the level has fallen appreciably, suspect leakage or overheating and arrange for the vehicle to be examined by a qualified technician.

If **ENGINE OVERHEATING** is displayed in the message centre, pull off the carriageway and allow the engine to idle for five minutes and then switch off for ten minutes. Start the engine and, provided that the warning does not re-occur, continue your journey avoiding harsh acceleration. Seek qualified assistance as soon as possible.

Topping up the coolant

WARNINGS



Never remove the filler cap when the engine is hot - escaping steam or scalding water could cause serious personal injury.



Antifreeze is highly flammable. Do not allow antifreeze to come into contact with naked flames or other sources of ignition (e.g. a hot engine) - a fire may result.



Unscrew the filler cap slowly, allowing the pressure to escape before removing completely.

Top up to the **MAX** mark on the side of the expansion tank. Use only a 50% mix of water and antifreeze meeting specification WSS M97B44 (coloured orange) Extended Life Coolant.

Refit the filler cap and hand-tighten securely until one click is heard.

Maintenance

Antifreeze

WARNINGS



Antifreeze is poisonous and can be fatal if swallowed - keep containers sealed and out of the reach of children. If accidental consumption is suspected, seek medical attention immediately.



If the fluid comes into contact with the skin or eyes, rinse immediately with plenty of water.

CAUTIONS



The use of non-approved antifreeze will have an adverse effect on the engine cooling system and therefore engine durability.



Antifreeze will damage painted surfaces; soak up any spillage with an absorbent cloth immediately and wash the area with a mixture of car shampoo and water.

Antifreeze contains important corrosion inhibitors. The antifreeze content of the coolant must be maintained at 50% ± 5% all year round (not just in cold conditions). To ensure that the anti-corrosion properties of the coolant are retained, the antifreeze content should be checked once a year and completely renewed every ten years, regardless of distance travelled. Failure to do so may cause corrosion of the radiator and engine components.

The specific gravity of a 50% antifreeze solution at 20°C (68°F) is 1.068 and protects against frost down to -40°C (-40°F).

Use antifreeze to specification WSS M97B44 (coloured orange) Extended Life Coolant.

BRAKE FLUID CHECK

WARNING



Seek qualified assistance immediately if brake pedal travel is unusually long, unusually short or if there is any significant loss of brake fluid. Driving under such conditions, could result in extended stopping distances or complete brake failure.



If the quantity of fluid in the brake reservoir drops below the recommended level, a red warning indicator in the instrument panel will illuminate and **BRAKE FLUID LOW** will be displayed in the message centre.

Note: If the warning indicator illuminates or the message is displayed while the vehicle is being driven, stop the vehicle as soon as safety permits, by gently applying the brakes. Check and top up the fluid level if necessary.

Checking the fluid level

WARNINGS



Brake fluid is highly toxic - keep containers sealed and out of the reach of children. If accidental consumption is suspected, seek medical attention immediately.



If the fluid comes into contact with the skin or eyes, rinse immediately with plenty of water.



Brake fluid is highly inflammable. Do not allow brake fluid to come into contact with naked flames or other sources of ignition (e.g. a hot engine) - a fire may result.



Do not drive the vehicle with the fluid level below the **MIN** mark.

Maintenance

With the vehicle on level ground, check the fluid level at least every week (more frequently in high mileage or arduous operating conditions).

The brake fluid reservoir is located beneath a cover panel, to the rear of the engine compartment. See **ENGINE COMPARTMENT OVERVIEW** (page 182).

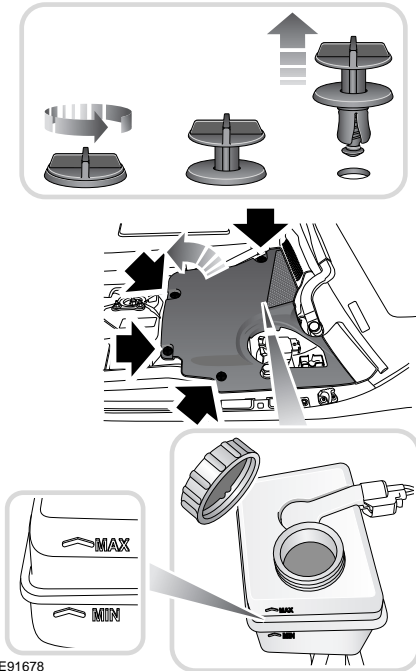

E91678

Remove the four fixings securing the cover panel.

Check that the fluid level is between the **MIN** and **MAX** marks on the side of the reservoir.

Topping up the fluid

CAUTION

- ⚠ Brake fluid will damage painted surfaces. Soak up any spillage with an absorbent cloth immediately and wash the area with a mixture of car shampoo and water.
- ⚠ Only use new fluid from an airtight container (fluid from open containers or fluid previously bled from the system, will have absorbed moisture, which will adversely affect performance and must not be used).

1. With the cover panel removed, clean the brake filler cap with a clean, dry cloth, before removing, to prevent dirt or moisture from entering the reservoir. Remove the filler cap.
2. Top up the reservoir to the **MAX** mark, using **Shell DOT4 ESL** brake fluid. If unavailable, a low viscosity brake fluid that meets ISO 49225 class 6 specification. Only fluid of this type and standard may be used.
3. Refit the filler cap securely.
4. Refit the cover panel.

Pedal free travel: The brake pedal free travel is 12.0 mm (0.47 inches).

Maintenance

POWER STEERING FLUID CHECK

WARNINGS



Power steering fluid is highly toxic. Keep containers sealed and out of reach of children. If accidental consumption of fluid is suspected, seek medical attention immediately.



If the fluid comes into contact with the skin or eyes, rinse immediately with plenty of water.



Power steering fluid is highly inflammable. Do not allow power steering fluid to come into contact with naked flames or other sources of ignition (e.g. a hot engine) - a fire may result.

Checking and topping up the fluid level

CAUTIONS



The engine must not be started if the fluid level has dropped below the **lower level** mark. Severe damage to the steering pump could result.



Seek qualified assistance immediately if there is a noticeable drop in the fluid level. Severe damage to the steering pump could result.



If fluid loss is slow, the reservoir may be topped-up to the upper level mark to enable the vehicle to be driven to a repair facility for examination. However, it is recommended that you seek qualified assistance before driving the vehicle.



It is imperative that the power steering system does not become contaminated in any way. Always use new fluid and clean the area around the reservoir neck both before and after topping up. Never return drained fluid to the system.

CAUTIONS



Power steering fluid will damage painted surfaces. Soak up any spillage with an absorbent cloth immediately and wash the area with a mixture of car shampoo and water.



Do not fill the reservoir above the **upper level** mark.

Check and top up the fluid level with the vehicle on level ground, the engine switched off and the system cold. Ensure that the steering wheel is not turned after stopping the engine.

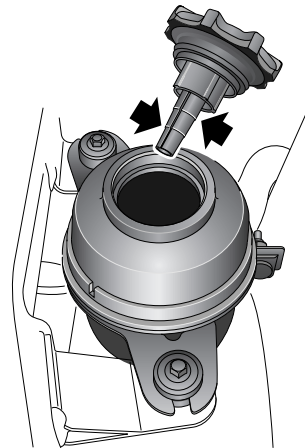

E91679

1. Clean the filler cap and surrounding area with a clean dry cloth, before removing, to prevent dirt or moisture from entering the reservoir.
2. Check that the fluid level is between the upper and lower marks (arrowed) on the reservoir dipstick.
3. If necessary, top-up with Pentosin CHF202 power steering fluid. Do not overfill.
4. Clean any spillage and refit the filler cap.

Maintenance

WASHER FLUID CHECK

WARNINGS



Washer fluid is highly toxic. Keep containers sealed and out of reach of children. If accidental consumption of fluid is suspected, seek medical attention immediately.



If the fluid comes into contact with the skin or eyes, rinse immediately with plenty of water.



Some screen washer products are inflammable, particularly if high or undiluted concentrations are exposed to sparking. Do not allow screen washer fluid to come into contact with naked flames or other sources of ignition (e.g. a hot engine) - a fire may result.



If the vehicle is operated in temperatures below 4°C (40°F), use a washer fluid with frost protection. In cold weather, failure to use a washer fluid with frost protection, could result in impaired vision and increase the risk of a vehicle crash.

CAUTIONS



Do not use an antifreeze or vinegar/water solution in the washer reservoir - antifreeze will damage painted surfaces, while vinegar can damage the windscreen washer pump.



Body panels may suffer discolouration as a result of screen washer fluid spillage. Take care to avoid spillage, particularly if an undiluted or high concentration is being used. If spillage occurs, wash the affected area immediately with water.

The washer reservoir supplies the windscreen and headlamp powerwash systems.

Check and top-up the reservoir level at least every week.

Fill with Jaguar Windscreen Washer Fluid, diluted with clean water as specified in the instructions on the bottle. Using a non-approved fluid may adversely affect the wiper blade rubber, resulting in ineffectual and noisy wiping.

Operate the washer switches periodically, to check that the nozzles are clear and properly directed.

Topping up the fluid

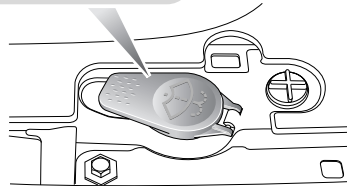
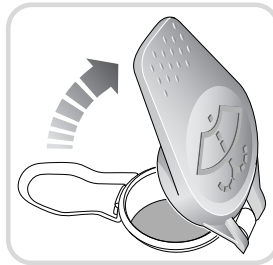

E91676

1. Clean cap before removing, to prevent dirt from entering the reservoir.
2. Open the filler cap.
3. Top up the reservoir until the fluid is visible in the filler neck.
4. Close the filler cap.

Maintenance

TECHNICAL SPECIFICATIONS

Lubricants and fluids

Part	Variant	Specification
Engine oil	All vehicles	Use only Castrol 5W-20 engine oil, meeting specification WSS M2C925-A.
Power steering fluid	All vehicles	Pentosin CHF202
Brake fluid	All vehicles	Shell DOT4 ESL ¹
Screen washer	All vehicles	Screen wash with frost protection
Coolant	All vehicles	50% mixture of water and antifreeze to specification WSS M97B44 (coloured orange) Extended Life Coolant.

Note: If Shell DOT4 ESL is not available, a low viscosity brake fluid meeting ISO 49225 Class 6 specification can be used. If in doubt, consult your Jaguar Dealer/Authorised Repairer.

Capacities

Item	Variant	Capacity
Fuel capacity	All vehicles	See FUEL TANK CAPACITY (page 170).
Engine oil refill and filter change	All vehicles	7.25 litres (12.8 pints)
Windscreen and headlamp washer reservoir	Normally aspirated engines	6.3 litres (11.1 pints)
	Supercharged engines	6.6 litres (11.6 pints)
Cooling system, including reservoir and climate control	Normally aspirated engines	10.4 litres (18.3 pints)
	Supercharged engines	10.0 litres (17.6 pints)

Note: The quoted capacities are approximate and provided as a guide only. All levels must be checked using the level markers, the dipstick or level plugs, as applicable.

Vehicle battery

BATTERY WARNING SYMBOLS

A label on the battery, depicts a number of warning symbols, as follows:



Do not allow any naked flames or other sources of ignition near the battery, as the battery may emit explosive gasses.



Ensure that when working near or handling the battery, suitable eye protection is worn. This will reduce the risk of eye damage caused by acid splashes.



To prevent risk of injury, do not allow children near the battery.



Be aware that the battery may emit explosive gasses.



The battery contains acid which is extremely corrosive and toxic.

BATTERY CARE

WARNINGS



Do not allow the battery electrolyte (fluid) to come into contact with your skin or eyes. It is both corrosive and toxic, and the resulting injuries can be severe. If any electrolyte does come into contact with your skin or eyes, immediately rinse the affected area with clean, cold water. Immediate medical advice will be required.



If battery electrolyte comes into contact with your skin and/or clothes you should remove the affected clothing and flush the skin with copious amounts of water. Seek medical assistance immediately.

WARNINGS



If battery electrolyte comes into contact with your eyes, flush with copious amounts of clean, cold water.

Seek medical assistance immediately and continue to flush with water.



If swallowed, battery electrolyte can be fatal. If electrolyte is swallowed seek medical assistance immediately.



Do not connect any 12 volt equipment directly to the battery terminals. Doing so may cause a spark, which can result in an explosion.



The cell plugs and vent pipe must be in place at all times when the battery is connected to the vehicle. Ensure that the vent pipe is clear of obstructions and not kinked. Failure to do so may cause a pressure build up in the battery, resulting in an explosion.



Do not expose the battery to a naked flame or spark, as the battery produces explosive, flammable gas.



Never jump start (boost) or charge, a frozen battery. Doing so can result in an explosion.



Remove all metal jewellery before working on, or near, the battery, and never allow metal tools or vehicle components to come into contact with the battery terminals. Metal objects can cause sparks, and/or short circuits, resulting in an explosion.



Do not allow the battery posts or terminals to come into contact with your skin. They contain lead, and lead compounds which are toxic. Always wash your hands thoroughly after handling the battery.

Vehicle battery

CAUTION



Do not allow battery electrolyte to come into contact with fabrics or painted surfaces. If battery electrolyte comes into contact with any surface, the surface should be washed down immediately with copious amounts of clean water. Battery electrolyte is both corrosive and toxic, and can damage a wide range of materials if left.

Your vehicle is fitted with a low maintenance battery, located in the luggage compartment. The exterior of the battery should be occasionally wiped clean, to remove any dirt or grease.

In hot climates, more frequent checks of the battery electrolyte level are required. If necessary, the battery cells can be topped up with distilled water.

Note: Do not connect any 12 volt equipment, (e.g. a 12 volt inspection lamp), directly to the battery terminals. Use the accessory socket, located in the glove box, for connecting Jaguar approved accessories.

Battery Monitoring System (BMS)

Your vehicle is equipped with BMS which manages the battery charging system and, if excessive battery discharge is occurring when the engine isn't running, shuts down non-essential electrical systems to protect battery power.

In the event that too many electrical systems are operational when the engine is not running, and the battery charge is insufficient, the audio system (if active) will be switched off. This will be confirmed by a pop-up message displayed on the touch-screen. If this occurs, switch on and run the engine for at least five minutes, preferably with all auxiliary electrical systems switched off (e.g. lights, wipers, climate control, seat heaters etc.).

Note: The audio system can be operated during this five minute period when the engine is running.

If the engine is switched off before the five minute period ends and the audio system is switched on, the pop-up message will re-appear on the touch-screen and the audio system will switch off again. For this reason, it is important that the engine is left running for the full five minute period.

If there is a fault in the battery charging system, **CHARGING FAULT** is displayed in the message centre. If this occurs, switch off all non-essential electrical systems and seek qualified assistance at the earliest opportunity.

BATTERY ACCESS

To gain access to the battery, remove the access cover as follows:

1. Unscrew and remove the four luggage retention hooks from the cover.
2. Pull the cover rearwards and remove from the vehicle.

Store the hooks and cover in a safe place and remember to refit them when access to the battery is no longer needed.

Vehicle battery

USING BOOSTER CABLES

WARNINGS



Always wear appropriate eye protection when working with batteries.



During normal use, batteries emit explosive hydrogen gas - ensure sparks and naked lights are kept away from the luggage compartment.



Do not attempt to start the vehicle if the electrolyte in the battery is suspected of being frozen.



Make sure both batteries are of the same voltage (12 volts), and that the booster cables have insulated clamps and are approved for use with 12 volt batteries.



Do not disconnect the discharged battery.



Do not connect positive (+) terminals to negative (-) terminals, and ensure booster cables are kept away from any moving parts in the engine compartment.



Do not connect a booster cable to the battery terminals of this vehicle. Always connect to the recommended remote terminals.

CAUTIONS



If using a boost-start vehicle, under no circumstances should the vehicles come into contact with each other. This could establish an earth connection, which may cause sparks and damage.



Do not run the donor vehicle's engine, when boost-starting this vehicle. If the donor vehicle's engine is running and the jump leads are disconnected, damage to this vehicle's electrical system will result.

This vehicle is fitted with automatic transmission. In the event of a discharged battery preventing a normal engine start, the vehicle cannot be started by pushing or towing. Either use booster cables connected to a donor battery (e.g. on another vehicle) or have a fully charged battery fitted by your Jaguar Dealer/Authorised Repairer.

Using booster cables (jump leads) from a donor battery, or a battery fitted to a donor vehicle, is the only approved method of starting a vehicle with a discharged battery. This procedure differs to that used to charge a battery, which should not be attempted with the battery connected to the vehicle. See **CHARGING THE VEHICLE BATTERY** (page 196).

Attaching the cables

WARNING



Do not use a 24 volt booster start system. These produce excessive voltage and can damage the vehicle's electrical system.

If a donor vehicle is to be used, both vehicles should be parked with their battery locations adjacent to each other. Ensure that the two vehicles do not touch.

Apply the parking brakes and ensure that the transmission of both vehicles is set in neutral (**P** - Park for vehicles with automatic transmission).

Ensure that both vehicles have all electrical systems off.

Where the booster cables are of a different colour (e.g. red and black), use red for positive (+). This aids identification and helps to avoid crossing positive (+) to negative (-). Take extra care to avoid crossing the polarity when using cables of the same colour.

Vehicle battery

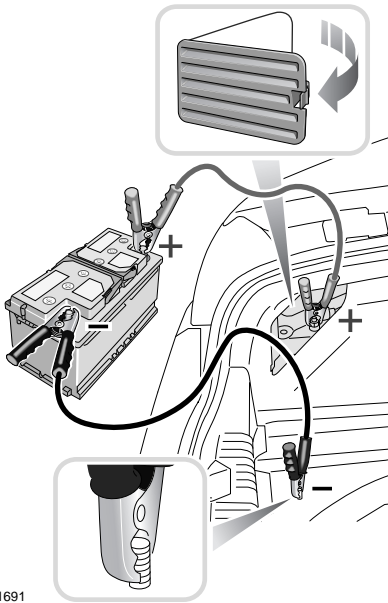

E91691

The following procedure must be followed exactly:

1. Remove the left-hand side luggage compartment trim panel cover, to access the vehicle battery positive (+) remote charge terminal, remove the protective cap from the terminal.
2. Attach one end of the red booster cable to the positive (+) terminal of the booster battery and the other end to the positive (+) remote charge terminal of the vehicle.
3. Lift the luggage compartment floor panel to reveal the spare wheel. Remove the protective cap from the negative (-) remote charge terminal of the vehicle.

4. Attach one end of the black booster cable to the negative (-) terminal of the donor battery and the other end to the negative (-) remote charge terminal of the vehicle.
5. Start the disabled vehicle. Allow the engine to idle for five minutes before disconnecting the cables.

Disconnecting the cables

1. Disconnect the black booster cable from the negative (-) remote charge terminal of the vehicle and the donor battery negative (-) terminal.
2. Disconnect the red booster cable from the positive (+) remote charge terminal of the vehicle and the donor battery positive (+) terminal.
3. Refit the terminal covers, trim panel and luggage compartment floor panel.

It may be necessary to reset the electric parking brake. See **ELECTRIC PARKING BRAKE (EPB)** (page 142).

Vehicle battery

CHARGING THE VEHICLE BATTERY

WARNINGS



Ensure that the correct type of battery charger used. Using an unsuitable charger may damage the battery and could cause the battery to explode.



Always charge the battery in a well ventilated area away from any naked flames, sparks or other ignition sources. During charging the battery can produce a highly explosive and flammable gas.

CAUTIONS



Battery disconnection, removal and replacement, should only be carried out by qualified personnel. Consult your Dealer/Authorised Repairer.



The battery must be disconnected and removed from the vehicle before charging. Failure to do so could result in damage to the vehicle's electrical system.



Always follow the instructions supplied with the battery charger. Failure to do so may result in damage to the battery.

CHANGING THE VEHICLE BATTERY

WARNINGS



Use caution when lifting the battery out of, or into, the vehicle. It is heavy and may cause injury when lifting or if dropped.



Do not tilt the battery more than 45°, as it may cause damage and may cause the electrolyte to leak out.

Battery electrolyte is highly corrosive and toxic.

CAUTIONS



Battery disconnection, removal and replacement, should only be carried out by qualified personnel. Consult your Dealer/Authorised Repairer.



If the vehicle battery is replaced by a new battery, the vehicle electrical system must be reset to the new battery by qualified personnel, to ensure maximum functionality. Consult your Dealer/Authorised Repairer.



Only a replacement battery of the same type and specification as the original should be fitted. Other batteries may vary in size or have different terminal positions, which could cause a fire hazard when connected to the vehicle's electrical system.



Do not rest the battery on any part of the vehicle, as it may cause damage due to its weight.



Do not run the engine with the battery disconnected. Doing so may damage the charging system.

Battery disposal



Used batteries should be recycled. However, batteries must be disposed of correctly, as they contain a number of harmful substances. Seek advice on disposal from a Jaguar Dealer/Authorised Repairer or your local authority.

Vehicle battery

EFFECTS OF BATTERY DISCONNECTION

After reconnecting the battery:

- Reset the electric parking brake. See **ELECTRIC PARKING BRAKE (EPB)** (page 142).
- Reset the power windows anti-trap function. See **ELECTRIC WINDOWS** (page 83).
- The trip computer will lose all recorded trip data and all trip functions will be reset to zero. The vehicle total odometer reading is retained.
- If the battery is disconnected for more than 72 hours, the radio preset channels will need to be reset.
- Reset the clock to the correct time. See **CLOCK** (page 124).
- Recalibrate the seat memory positions. See **MEMORY FUNCTION** (page 122).

The engine electronic control system automatically adapts to certain characteristics of the vehicle. When the battery is disconnected, these adaptations are lost.

On reconnection, therefore, some slightly abnormal drive symptoms may occur and the vehicle may need to be driven 16 kilometres (10 miles) or more while the control system re-adapts.

When the vehicle main battery is disconnected and then reconnected, the security system immediately returns to the state that it was when the battery was disconnected.

Note: *Ensure that a remote handset is available to disarm the system when reconnecting the battery. Either press the unlock button on the transmitter, or press the START/STOP button.*

Wheels and tyres

GENERAL INFORMATION

Tyre markings

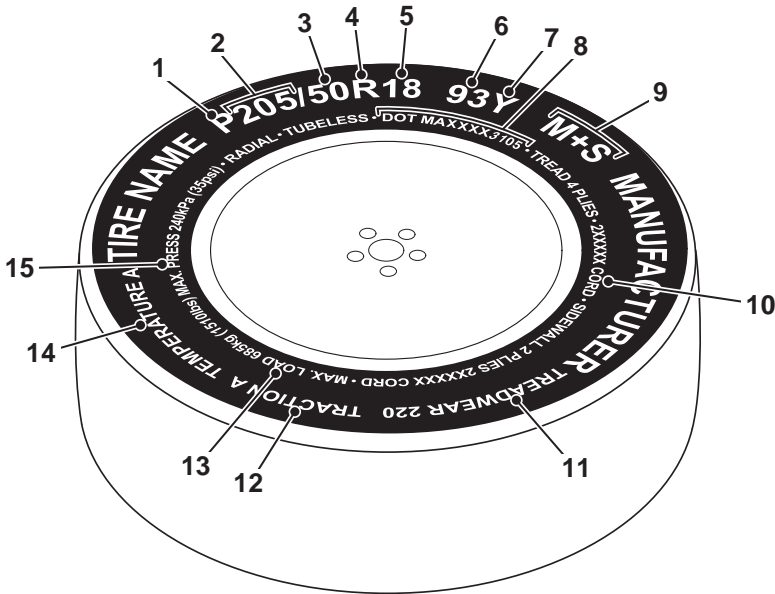

JAG1525

1. P indicates that the tyre is for passenger vehicle use.
2. The width of the tyre from sidewall edge to sidewall edge in millimetres.
3. The aspect ratio, also known as the profile, gives the sidewall height as a percentage of the tread width. So, if the tread width is 205 mm, and the aspect ratio is 50, the sidewall height will be 102 mm.
4. R indicates that the tyre is of Radial ply construction.
5. The diameter of the wheel rim (in inches).
6. The load index for the tyre. This index is not always shown.
7. The speed rating denotes the maximum speed at which the tyre should be used for extended periods. †
8. Tyre manufacturing standard information, which can be used for tyre recalls and other checking processes. Most of this information relates to the manufacturer, place of manufacture etc. The last four numbers are the date of manufacture. For example, if the number was 3106, the tyre was made in the 31st week of 2006.
9. M+S or M/S indicates that the tyre has been designed with some capability for mud and snow.
10. The number of plies in both the tread area, and the sidewall area, indicates how many layers of rubber coated material make up the structure of the tyre. Information is also provided on the type of materials used.

Wheels and tyres

11. Wear rate indicator. A tyre rated at 400 for example, will last twice as long as a tyre rated at 200.
12. The traction rating grades a tyre performance when stopping on a wet road surface. The higher the grade the better the braking performance. The grades from highest to lowest are, AA, A, B, and C.
13. The maximum load which can be carried by the tyre.
14. Heat resistance grading. The tyres resistance to heat is grade A, B, or C, with A indicating the greatest resistance to heat. This grading is provided for a correctly inflated tyre, which is being used within its speed and loading limits.
15. The maximum inflation pressure for the tyre. This pressure should not be used for normal driving. See **TYRE CARE** (page 199).

† Speed ratings

Rating	Speed km/h (mph)
Q	160 (99)
R	170 (106)
S	180 (112)
T	190 (118)
U	200 (124)
H	210 (130)
V	240 (149)
W	270 (168)
Y	300 (186)

TYRE CARE

WARNINGS



Defective tyres are dangerous. Do not drive the vehicle if a tyre is damaged, excessively worn, or incorrectly inflated. Doing so may lead to premature tyre failure.



Avoid contaminating the tyres with vehicle fluids, as they may cause damage to the tyre.



Avoid spinning the wheels. The forces released, can damage the structure of the tyre and cause it to fail. Doing so may lead to premature tyre failure.



If wheel spin is unavoidable due to loss of traction (in deep snow, for example), do not exceed the 50 km/h (30 mph) point on the speedometer. Doing so may lead to premature tyre failure.



Do not exceed the maximum pressure stated on the sidewall of the tyre. Over-inflation could cause the tyre to fail suddenly.

All of the vehicle's tyres (including the spare) should be checked regularly for damage, wear and distortion. If you are in any doubt about the condition of a tyre, have it checked immediately by a tyre repair centre, or your Jaguar Dealer/ Authorised Repairer.

Wheels and tyres

TYRE PRESSURES

WARNINGS



Never drive your vehicle if the tyre pressures are incorrect.

Under-inflation causes excessive flexing and uneven tyre wear. This can lead to sudden tyre failure. Over-inflation causes a harsh ride, uneven tyre wear, sudden tyre failure and poor handling.



Pressure checks should only be carried out when the tyres are cold and the vehicle has been stationary for more than three hours. A hot tyre at or below recommended cold inflation pressure is dangerously under-inflated.



If the vehicle has been parked in strong sunlight, or used in high ambient temperatures, do not reduce the tyre pressures. Move the vehicle into the shade and allow the tyres to cool before re-checking the pressures.

Checking the tyre pressures

WARNINGS



Tyre pressures should be checked regularly using an accurate pressure gauge, when the tyres are cold.

Failure to properly maintain your tyre pressures could increase the risk of tyre failure, resulting in loss of vehicle control and personal injury.

In the interest of safety, reliability and fuel efficiency, check the tyres, including the spare, for condition and pressure on a weekly basis and before long journeys.

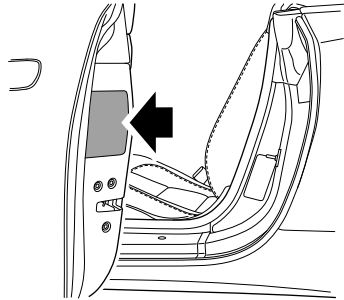

E91695

The recommended tyre pressures are listed on a placard label, fixed to the end of the left-hand side door. These pressures provide optimum ride and handling characteristics for all normal operating conditions.

Pressure checks must be carried out when the tyres are cold and the vehicle has been standing in ambient local conditions for at least one hour.

Do not check tyre pressures immediately after the vehicle has travelled in excess of 1.6 km (1.0 mile). Tyre temperatures and pressures increase when running. Deflating a warm tyre to the recommended pressure will result in under-inflation.

If tyre pressures are checked while the vehicle is inside a protected covered area (e.g. a garage) and subsequently driven in lower outdoor temperatures, tyre under-inflation could occur.

A slight pressure loss occurs naturally with time. If this exceeds 0.14 bar (2 lbf/in², 14 kPa.) per week, have the cause investigated and rectified by qualified assistance.

If winter tyres are fitted, please refer to the winter tyre pressure information. See **USING WINTER TYRES** (page 205).

Wheels and tyres

The following procedure should be used to check and adjust the tyre pressures.

1. Remove the valve cap.
2. Firmly attach a tyre pressure gauge/inflator to the valve.
3. Read the tyre pressure from the gauge and add air if required.
4. If air is added to the tyre, remove the gauge and re-attach it before reading the pressure. Failure to do so may result in an inaccurate reading.
5. If the tyre pressure is too high, remove the gauge and allow air out of the tyre by pressing the centre of the valve. Refit the gauge to the valve and check the pressure.
6. Repeat the process, adding or removing air as required, until the correct tyre pressure is reached.
7. Refit the valve cap.

Note: It is an offence in certain countries to drive a vehicle with incorrect tyre pressures.

Note: It is the driver's responsibility to ensure that the tyre pressures are correct.

Pressure compensation for ambient temperature changes

If the intended journey will take the vehicle into an area where the ambient local temperature is known to be lower than the journey start point, tyre pressure under-inflation could occur.

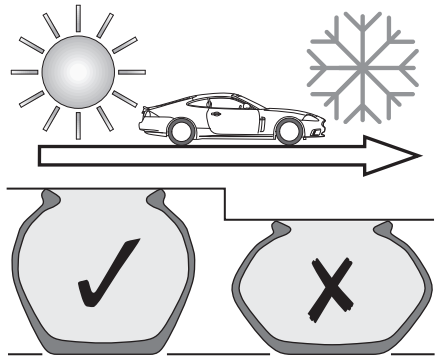

JAG1384

A colder ambient local temperature will reduce pressure within the tyre. An effect is to decrease sidewall height and to increase tyre shoulder wear, with the potential for tyre failure. Vehicle dynamics could also be adversely affected.

In order to minimise this effect, tyre pressures can be adjusted to compensate before the start of the journey. Alternatively, tyre pressures can be adjusted when the area of lower ambient temperature is reached.

In this situation, the vehicle must be left in the ambient local temperature for a least one hour before tyre pressure is adjusted.

To compensate for colder ambient temperatures, tyre pressures should be increased by 0.14 bar (2lb/in², 14 kPa) for each 10°C (20°F) decrease.

Note: Ensure that correct tyre pressures are maintained when moving to areas of differing ambient temperature.

The Tyre Pressure Monitoring system (TPM system) may issue a warning if the under-inflation becomes significant. When driving through variable climatic conditions the TPM system warnings may be intermittent.

Wheels and tyres

Tyre pressure compensation chart - high ambient temperatures

Tyre pressure temperature compensation	
Ambient temperature °C (°F)	Pressure compensation bar (lbf/in ² , kPa)
20 (68)	use placard label
30 (86)	+ 0.14 (2, 14)
40 (104)	+ 0.28 (4, 28)
50 (122)	+ 0.41 (6, 41)

Flat spots

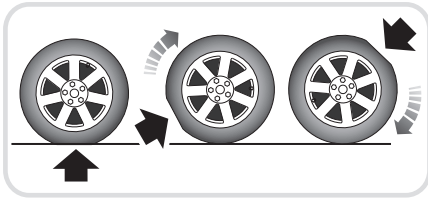

E80322

In areas of extended high ambient temperature, vehicle tyres can be affected by a softening of the tyre sidewall. If the vehicle is stationary for long periods, the effect is to slightly deform the tyre at the point where the tyre meets the standing surface. This is known as a flat spot.

This is normal tyre behaviour. However, when the vehicle is subsequently driven, vibration may be experienced from the flat spot. The condition will steadily improve with additional mileage.

In order to minimise flat spotting, tyre pressures can be increased. Tyre pressures should be increased by 0.14 bar (2 lbf/in², 14 kPa), for each 10°C (20°F) increase in temperature above 20°C (68°F).

Long term storage

Flat spotting can be minimised during long term storage, by increasing the tyre pressures to the maximum indicated on the tyre sidewall.

Note: The tyre pressures should be reduced to the correct pressures, before the vehicle is driven.

TYRE WEAR

Good driving practise will improve the mileage you obtain from your tyres and avoid unnecessary damage.

- Always ensure that the tyre pressures are correctly adjusted.
- Always observe the posted speed limits and advisory speeds for bends.
- Avoid pulling away quickly or hard acceleration.
- Avoid making fast turns or braking sharply.
- Wherever possible, avoid potholes or obstacles on the road.
- Do not drive up kerbs or rub the tyres against them when parking.

Wear indicators

WARNINGS



Wear indicators show the minimum tread depth recommended by the manufacturer. Tyres which have worn to this point will have reduced grip and poor water displacement characteristics.

CAUTION



If tread wear is uneven across the tyre, or the tyre wears excessively, the vehicle should be checked by your Dealer/ Authorised Repairer as soon as possible.

Wheels and tyres



When the tread has worn down to approximately 2mm, wear indicators start to appear at the surface of the tread pattern. This produces a continuous band of rubber across the tread, as a visual indicator.

To maintain performance and grip, the tyre must be replaced as soon as the wear indicator becomes visible - sooner, if legislation requires replacement at a greater tread depth.

Note: *Tread depth should be checked regularly, in some cases more frequently than the service intervals. For advice on checking tyres, contact your Dealer/Authorised Repairer or a tyre dealer.*

Age degradation

Tyres degrade over time, due to the effects of ultraviolet light, extreme temperatures, high loads and environmental conditions. It is recommended that tyres are replaced at least every six years, but they may require replacement more frequently.

Jaguar recommends that even if unused, the spare tyre be replaced at the same time as the four road tyres.

Punctured tyres

WARNINGS



Do not drive the vehicle with a punctured tyre. Even if the punctured tyre has not deflated, it is unsafe to use, as the tyre may deflate suddenly at any time. See **TYRE REPAIR KIT** (page 210).

Tyre checks

Not all punctures result in the tyre deflating immediately. Therefore, it is important to check the tyres for damage and foreign objects regularly.

When driving, if a sudden vibration or change in the vehicle's handling is noticed, reduce speed immediately. Do not brake hard or make any sudden manoeuvres or direction changes. Drive slowly to an area off the main highway and stop the vehicle.

Note: *Driving the vehicle to a safe area, may cause damage to the punctured tyre, but occupant safety is far more important.*

Inspect the tyres for signs of punctures, damage or under inflation. If any damage or deformity is detected, the tyre should be replaced. If a spare tyre is not available, then the vehicle should be recovered to a tyre repair centre or Dealer/Approved Repairer.

Damage

CAUTION



Do not use paraffin (kerosene), because this has a detrimental effect on rubber.

Excessive local distortion can cause the casing of a tyre to fracture and may lead to premature failure. Tyres should be examined especially for cracked walls, exposed cords, etc. Flints and other sharp objects must be removed from the tyre tread; if left in they may work through the cover. Clean off any oil or grease contamination by using a suitable cleaner.

Tyre repair

Damaged tyres should be replaced with new tyres. They must not be repaired in view of the high performance capability of the vehicle.

Wheels and tyres

Replacement tyres

WARNINGS



Do not fit cross-ply tyres.



Do not fit tubed tyres.



Do not swap tyres around the vehicle. Tyres bed in to the specific characteristics of each wheel

position. Swapping them around may affect the vehicle's handling and traction. The rear wheel and tyre assemblies are larger than the front. These larger assemblies must never be fitted to the front of the vehicle.



Always fit replacement tyres of the same type, and wherever possible, of the same make and tread pattern.



Replacement wheels should be genuine Jaguar parts. This will maintain the designed driving characteristics.



If the use of tyres not recommended by Jaguar is unavoidable, ensure that you read, and fully comply with, the tyre manufacturer's instructions. Failure to do so may lead to tyre failure, due to incorrect fitment or use.

Ideally, tyres should all be replaced at the same time. If this is not possible, replace the tyres in pairs (front or rear). When tyres are replaced, the wheels should always be re-balanced and the alignment checked.

The correct tyre specification for your vehicle can be found on the tyre information label.

The installation of replacement tyres with steel cord body plies in the tyre sidewall may cause malfunction of the TPM system and is not recommended (cord material information is moulded on the tyre wall).

Additionally, if your vehicle was equipped with run-flat tyres, replacing them with tyres that are not identical to those originally fitted, may cause malfunction of the TPM system and is not recommended.

Always check your TPM system indicator after replacing one or more tyres on your vehicle. See **TYRE PRESSURE MONITORING SYSTEM** (page 214).

Directional tyres

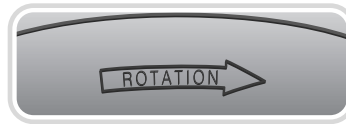

E95182

On some models, directional tyres are fitted. Directional tyres are designed to operate correctly when rotating forwards (when the vehicle is travelling forwards).

The directional indicator on the tyre (see examples illustrated) should, when at the top of a tyre, point towards the front of the vehicle.

Wheels and tyres

USING WINTER TYRES

Winter tyres are more suitable during extremes of low temperatures, snow and ice and will considerably improve the vehicle's handling during these conditions.

Do not exceed 240 km/h (150 mph) when using Jaguar approved winter tyres.

Winter tyres must be fitted on all four wheels.



CAUTION



Tyres with an all season icon or **M+S** have a level of winter performance and need not be replaced.

Approved winter tyre sizes

Front:

- Dunlop Wintersport M3 - 245/45R18 96V.
- Pirelli Sotto Zero - 245/45R18 100V.
- Dunlop Wintersport M3 - 245/40R19 98V.
- Pirelli Sotto Zero - 245/40R19 98V.
- Pirelli Sotto Zero - 255/35R20 97V.

Rear:

- Dunlop Wintersport M3 - 265/40R18 97V.
- Pirelli Sotto Zero - 275/40R18 103V.
- Dunlop Wintersport M3 - 275/35R19 96V.
- Pirelli Sotto Zero - 275/35R19 100V.
- Pirelli Sotto Zero - 285/30R20 99V.

Winter tyre pressures

Up to 240km/h (150 mph)	
Front	2.3 bar (33 lbf/in ² , 230 kPa)
Rear	2.5 bar (36 lbf/in ² , 250 kPa)

CHANGING A ROAD WHEEL

WARNINGS



Always ensure replacement tyres have the correct rating and specifications (e.g. load index, size, speed rating) for your vehicle.



When using tyres other than those recommended by Jaguar, do not exceed the speed capacity recommended by the manufacturer.



Wheels are extremely heavy. Take care when lifting and particularly when removing and replacing a wheel in its storage position in the luggage compartment.

If a wheel change is required, pull off the road completely. Park on ground which is as level and solid as possible. Ensure that the vehicle is clear of any objects that will obstruct the safe removal of the wheel. Switch on hazard warning lamps and display a warning triangle.

Regular maintenance of tyres contributes not only to safety, but to the designed function of the vehicle. Road-holding, steering and braking are especially vulnerable to incorrectly pressurised, badly fitted or worn tyres.

Tyres of the correct size and type, but of different make, can have widely varying characteristics. It is therefore recommended that Jaguar approved tyres are fitted to all wheels.

Wheels and tyres

CAUTION



Ultra high performance tyres.

This vehicle is equipped with an Ultra High Performance (UHP) tyre and wheel combination designed to give maximum dry road performance with consideration for aquaplaning resistance. UHP tyres have performance enhancing soft rubber tread compound. If driven aggressively they may suffer rapid tread wear and a shorter life than can be expected from other tyre types. This wheel and tyre combination is more susceptible to damage from road hazards.

Do not use this combination for driving on snow or ice. High performance tyres must be replaced with winter tyres when weather conditions dictate.

Temporary use spare wheel

WARNINGS



Note the temporary use spare wheel warning label. Adhere to instructions on the label. Failure to comply can be dangerous.



When a temporary use spare wheel is fitted, drive with caution and replace with the specified wheel and tyre as soon as possible.



Do not fit more than one temporary use spare wheel and tyre assembly at one time.



The temporary use spare wheel must be inflated to 4.2 bar (60 lbf/in², 420 kPa) and cannot be repaired.



Temporary use spare wheel maximum speed is 80 km/h (50 mph).

WARNINGS



If the vehicle is fitted with a Tyre Pressure Monitoring system (TPM System). See **TYRE PRESSURE MONITORING SYSTEM** (page 214).



DSC must be **on** when the temporary use spare wheel is in use.

Locking wheel nuts

Vehicles may be equipped with a locking wheel nut on each wheel. These are similar to standard wheel nuts, and can only be removed using the special adaptor provided with the jacking equipment.

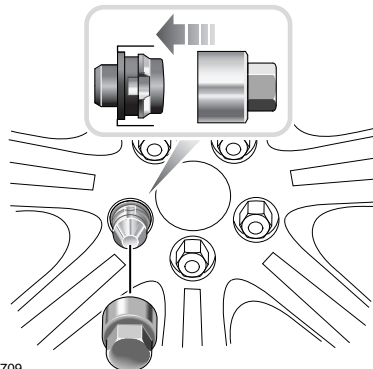

E91709

1. Insert the adaptor firmly onto the locking wheel nut.
2. Using the wheel brace, unscrew the wheel nut and adaptor.
3. Return the locking wheel nut adaptor to the correct storage position.

Note: A code number is stamped on the side of the locking nut. Ensure the number is recorded on the Security Card supplied with the literature pack. Quote this number if a replacement is required. Do not keep the Security Card in the vehicle.

Wheels and tyres

Spare wheel location

The spare wheel and jacking equipment are stored under the luggage compartment floor panel.

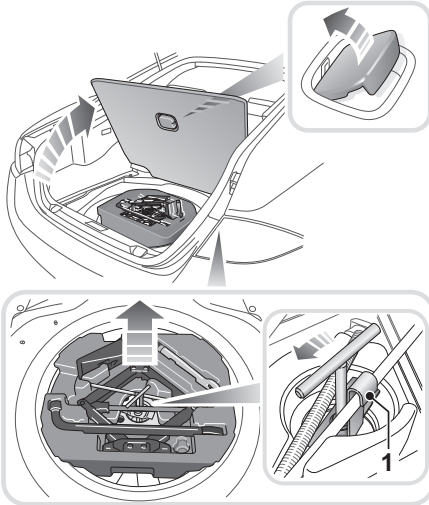

JAG1425

To remove the spare wheel, remove the luggage compartment floor panel and unscrew the Tee bolt, releasing the retaining clamp and hook (1).

Remove the tool tray from the spare wheel and remove the spare wheel from the luggage compartment.



Remove the jack and wheel nut wrench from the stowage tray.

Note: When refitting the Tee bolt and clamp, ensure that the retaining hook (1) fits over the jack handle, as illustrated.

Note: Examine the jack occasionally and clean and grease the threads to ensure it is always ready for an emergency.

Wheel changing safety

WARNINGS

-  Always find a safe place to stop, off the highway and away from traffic.
-  Ensure that the vehicle is on firm, level ground.
-  Switch on the hazard warning lamps.
-  Ensure that all passengers and animals are out of the vehicle and in a safe place, away from the highway.
-  Place a warning triangle at a suitable distance behind the vehicle, facing towards oncoming traffic.
-  Ensure that the front wheels are in the straight ahead position and engage the steering lock.
-  Apply the parking brake and engage Park (P).
-  Ensure that the jack is on firm level ground.
-  Never place anything between the jack and the ground, or the jack and the vehicle.
-  When one rear wheel is lifted off the ground, the selection of Park (P), will not prevent the vehicle from moving and possibly slipping off the jack, as the parking brake only operates on the rear wheels.
-  Do not start or run the engine, while the vehicle is supported only by a jack.
-  The jack is designed for use when changing a wheel only. Never work beneath the vehicle with the jack as the only means of support - use vehicle support stands.

Wheels and tyres

WARNINGS



Always chock the wheel diagonally opposite the wheel to be changed, using the chock supplied in the tool kit. Chock the front of a front wheel or the rear of a rear wheel.



If jacking the vehicle on a slight slope is unavoidable, place chocks on the downhill side of the two opposite wheels. An additional chock will be needed.



Take care when lifting the spare wheel and removing the punctured wheel. The wheels are heavy and can cause injuries, if not handled correctly.



Remove the spare wheel prior to jacking the vehicle, to avoid destabilising the vehicle when raised.



Take care when loosening the wheel nuts. The wheel brace may slip off if not properly attached, and the wheel nuts may give way suddenly. Either unexpected movement may cause injury.

Wheel changing procedure

WARNINGS



Do not attempt to lift the vehicle unless the jack head is fully engaged in the jacking point.



Ensure that the parking brake is applied.

CAUTION



Ensure before raising the vehicle that the jack is correctly positioned to avoid any damage to the vehicle sills or sill panels.

1. Ensure that all passengers are in a safe place, clear of the vehicle.
2. Apply the parking brake and select gear position **P** (Park).

3. Ensure that the jack is placed on firm and level ground.

Observe the instructions printed on the jack.

Use the jack only for lifting the vehicle during wheel changing and only use the jack which is stored in the vehicle.

Before raising the vehicle slacken, but do not remove the wheel nuts.

Do not start or run the engine while the vehicle is supported only by a jack.

There are four jacking points on the underside of the floor. Two indented, triangular indicators are provided on each sill cover. These indicate the location for the jack.

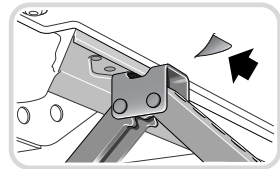
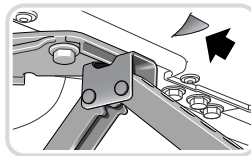
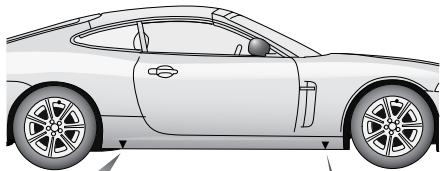

E91711

The simplest way to correctly locate the jacking point is to feel along the sill panel to the triangular indentation and then fit the jack to the body, not to the sill panel.

Carefully raise the vehicle by turning the jack handle. Stop jacking the vehicle when the tyre just clears the ground. Minimum tyre lift gives maximum vehicle stability.

Wheels and tyres

Remove the wheel nuts and the wheel.

To remove the centre badge use the plastic tipped end of the wheel nut wrench handle, push the centre badge from its housing from the inside of the wheel.

Push the centre badge into the replacement wheel. If the temporary use spare wheel is to be fitted, keep the centre badge safely and fit it to the repaired full size wheel when it has been refitted.

Fit the spare wheel and loosely secure with the wheel nuts.

Tightening the wheel nuts

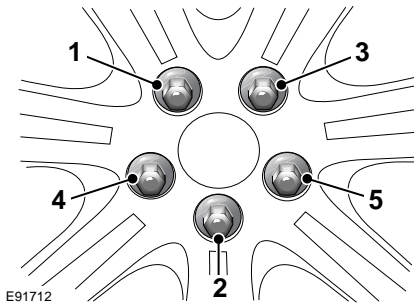

Using the wheel nut wrench, lightly tighten the wheel nuts alternately using the sequence shown in the illustration.

Lower the jack and tighten the wheel nuts alternately. Do not overtighten by using foot pressure or extension bars on the wheel nut wrench.

At the earliest opportunity have the wheel nuts tightened with a torque wrench to 125 Nm (92 lb.ft).

This torque must not be exceeded.

Stowing the equipment

Place the storage tray with the jack and wrench in the wheel well.

Secure in position with the Tee bolt and clamp, ensuring the hook on the clamp locates over the jack handle.

Reposition the luggage compartment floor panel.

Place the removed road wheel in the luggage compartment. The full size road wheel will not be able to be completely stowed in the wheel well.

CAUTION

 Convertible only. The luggage separator will need to be removed, before stowing the wheel in the luggage compartment. See **OPENING THE CONVERTIBLE TOP** (page 113).

Wheels and tyres

TYRE REPAIR KIT

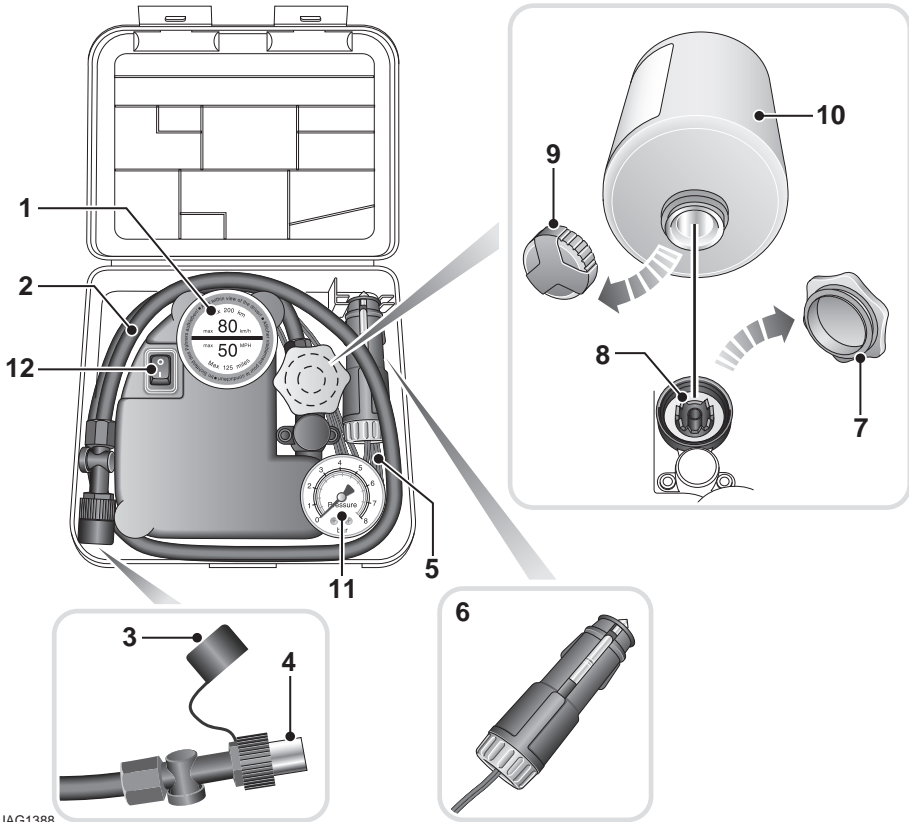

JAG1388

1. Maximum speed label. 80 km/h (50 mph).
2. Tyre inflation hose.
3. Inflation hose protective cap.
4. Inflation hose connector.
5. Compressor power cable.
6. Power cable connector.
7. Sealant bottle receiver cap (orange).
8. Sealant bottle receiver.
9. Sealant bottle cap.
10. Sealant bottle.
11. Tyre pressure gauge.
12. Compressor on/off switch. (1 = on, 0 = off).

Note: The sealant used in the tyre repair kit has a shelf life, and the expiry date is shown on the side of the sealant bottle. Ensure that the bottle is replaced before the expiry date.

Wheels and tyres

WARNINGS



To ensure vehicle safety, it is essential that you read and understand the following information. Failure to follow the instructions given here, may lead to serious tyre damage and may result in death or serious injury.



If you are in any doubt regarding your ability to carry out the instructions, contact your Jaguar Dealer/Approved Repairer before attempting the repair.

Your vehicle may not be equipped with a spare tyre. If this is the case, in its place you will find a Jaguar tyre repair kit (except where run-flat tyres are fitted). The Jaguar tyre repair kit can be used to repair one tyre, and it is essential that you read the following guide before attempting a repair.

The Jaguar tyre repair kit seals most punctures caused by nails, or similar items, with a maximum diameter of 6 mm (1/4 inch).

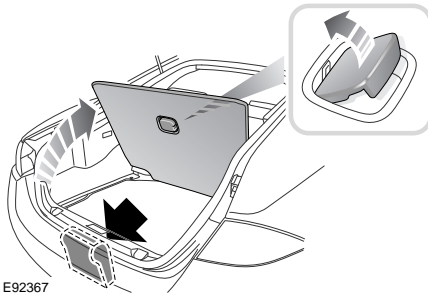

E92367

The tyre repair kit is located in the rear underfloor storage compartment under the liner.

Tyre repair kit safety information

WARNINGS



Some tyre damage may only be partially sealed, or may not seal at all, depending on the amount and type of damage. Any loss of tyre pressure can seriously affect vehicle safety.



Do not use the tyre repair kit if the tyre has been damaged by driving while under-inflated.



Only use the tyre repair kit to seal damage located within the tyre tread area.



Do not use the tyre repair kit to seal damage to the tyre sidewall.



Do not exceed 80 km/h (50 mph) when a repaired tyre is fitted to the vehicle.



The maximum distance that should be driven when a repaired tyre is fitted, is 200 km (125 miles).



When a repaired tyre is fitted, drive with caution and avoid sudden braking or steering manoeuvres where possible.



Only use the tyre repair kit for the vehicle with which it was supplied.



Do not use the tyre repair kit for any other purpose than tyre repair.



Never leave the tyre repair kit unattended when in use.



Only use the tyre repair kit within the -30°C to +70°C temperature range.



Always keep children and animals at a safe distance from the tyre repair kit when in use.



Do not stand directly beside the compressor when it is operating.

Wheels and tyres

WARNINGS



Check the tyre sidewall prior to inflation. If any cracks, damage, or deformities are apparent do not inflate the tyre.



Watch the tyre sidewall during inflation. If any cracks, bumps, deformities or similar damage appears, switch off the compressor, and deflate the tyre.

Using the Jaguar tyre repair kit

WARNINGS



Avoid skin contact with the sealant which contains natural rubber latex.



If the tyre inflation pressure does not reach 1.8 bar (26 lbf/in²) within seven minutes, the tyre may have suffered excessive damage. A temporary repair will not be possible, and the vehicle should not be driven until the tyre has been replaced.

CAUTIONS



Before attempting a tyre repair, ensure that the vehicle is parked safely, as far away from passing traffic as possible.



Ensure that the parking brake is applied, and **P** (Park) is selected.



Do not attempt to remove foreign objects such as nails, screws, etc. from the tyre.



To prevent battery drain, always run the engine when using the compressor, unless the vehicle is in an enclosed or poorly ventilated space, as this may cause asphyxiation.



To prevent overheating, do not operate the compressor continuously for longer than ten minutes.

Note: All vehicle drivers and occupants should be made aware that a temporary repair has been made to a tyre fitted to the vehicle. They should also be made aware of the special driving conditions imposed when using a repaired tyre.

1. Open the tyre repair kit and peel off the maximum speed label. Attach the label to the fascia in the driver's field of view. Take care not to obstruct any of the instruments or warning indicators.
2. Uncoil the compressor power cable and the inflation hose.
3. Unscrew the orange cap from the sealant bottle receiver and the red sealant bottle cap.
4. Screw the sealant bottle into the receiver (clockwise) until tight.
 - Screwing the bottle onto the receiver will pierce the bottle's seal. Do not unscrew a full or partly used bottle from the receiver. Doing so will result in the sealant leaking from the bottle.
5. Remove the valve cap from the damaged tyre.
6. Remove the protective cap from the inflation hose and connect the inflation hose to the tyre valve. Ensure that the hose is screwed on firmly.
7. Ensure that the compressor on/off switch is in the off (**O**) position.
8. Insert the power cable connector into the auxiliary power socket in the glove box. See **AUXILIARY POWER SOCKET** (page 125).
9. Unless the vehicle is in an enclosed or poorly ventilated area, start the engine.
10. Set the compressor on/off switch to the on (**I**) position.

Wheels and tyres

11. Inflate the tyre to a minimum of 1.8 bar (26 lbf/in², 180 kPa) and a maximum of 3.5 bar (51 lbf/in², 350 kPa).
 - When pumping the sealant through the tyre valve, the pressure may rise up to 6 bar (87 lbf/in², 600 kPa). The pressure will drop again after approximately 30 seconds.
12. During inflation, switch the compressor off briefly, to check the tyre pressure using the gauge mounted on the compressor.
 - It should not take longer than seven minutes to inflate the tyre. If the tyre has not reached the minimum pressure after seven minutes, the tyre should not be used.
13. Once the tyre has been inflated to at least 1.8 bar (26 lbf/in²), switch off the compressor. If desired, the engine may be turned off after the compressor has been turned off.
14. Remove the power connector from the auxiliary power socket.
15. Remove the inflation hose from the tyre valve by unscrewing it as quickly as possible (counterclockwise).
16. Replace the inflation hose protective cap, and the tyre valve cap.
17. Do not remove the sealant bottle from the receiver.
18. Ensure that the tyre repair kit is placed securely in the vehicle. You will need to use the kit to check the tyre pressure after 3 km (2 miles), so ensure that it is easily accessible.
19. Immediately drive the vehicle for 3 km (2 miles), to allow the sealant to coat the inner surface of the tyre and form a seal at the puncture. Observe the sticker indicating the maximum permissible speed.

Checking the tyre pressure after a repair

WARNINGS



When driving the vehicle, if you experience vibrations, abnormal steering or noises, reduce speed immediately. Drive with extreme caution and reduced speed, to the first safe place to stop the vehicle. Visually examine the tyre and check its pressure. If there are any signs of damage or deformity to the tyre, or the tyre pressure is below 1.3 bar (19 lbf/in², 130 kPa), do not continue driving.



Consult a tyre repair centre, or your Jaguar Dealer/Authorised Repairer for advice concerning the replacement of a tyre after using a tyre repair kit.

1. Drive the vehicle for 3 km (2 miles) then stop in a safe place. Carry out a visual examination of the tyre's condition.
2. Remove the protective cap from the inflation hose.
3. Screw the inflation hose connector firmly onto the tyre valve.
4. Read the tyre pressure from the gauge.
5. If the pressure of the sealant filled tyre is above 1.3 bar (19 lbf/in², 130 kPa), adjust the pressure to the correct value. See **TYRE CARE** (page 199).
6. Ensure that the compressor on/off switch is in the off position (**O**) and insert the power cable connector into the auxiliary power socket.

Wheels and tyres

If the vehicle is in a well ventilated area, start the engine.

7. Switch on the compressor (I), and inflate the tyre to the correct pressure.
8. To check the tyre pressure, turn off the compressor then read the pressure from the gauge.
9. When the compressor is off, if the tyre pressure is too high, release the required amount of pressure using the pressure relief valve.
10. Once the tyre is inflated to the correct pressure, switch off the compressor and remove the power plug from the auxiliary socket.
 - The use of the tyre repair kit sealant may lead to error prompts and incorrect readings of the Tyre Pressure Monitoring system. Therefore, use the tyre repair kit pressure gauge to check and adjust the damaged tyre's inflation pressure.
11. Unscrew the inflation hose connector from the tyre valve, replace the tyre valve cap and the inflation hose connector protective cap.
12. Do not remove the sealant bottle from the receiver.
13. Ensure that the tyre repair kit (including the bottle and receiver caps) is placed securely in the vehicle.
14. Drive to the nearest tyre repair centre, or Jaguar Dealer/Authorised Repairer, for a replacement tyre to be fitted. Ensure that you make the repair centre aware that the tyre repair kit has been used, before the tyre is removed.
15. Both the tyre inflation hose and the sealant bottle should be replaced, once a new tyre has been fitted.



Used sealant bottles and the tyre inflation hose, should be disposed of by a tyre specialist or your Jaguar Dealer/Authorised Repairer in compliance with local waste disposal regulations.

TYRE PRESSURE MONITORING SYSTEM

WARNINGS



The Tyre Pressure Monitoring (TPM) system is not a substitute for manually checking tyre pressures. Tyre pressures should be checked regularly, using an accurate pressure gauge when cold. Failure to properly maintain your pressures, could increase the risk of tyre failure, with consequential loss of vehicle control and personal injury.



The TPM system cannot register damage to a tyre. Regularly check the condition of your tyres, especially if the vehicle is driven off-road.

CAUTION



When inflating tyres, care should be taken to avoid bending or damaging the TPM system valves. Always ensure correct alignment of the inflation head to the valve stem.

Note: *Non-approved accessories may interfere with the system. If this occurs, **TYRE PRESSURE SYSTEM FAULT** is displayed in the message centre.*

Note: *Different types of tyre may affect the performance of the TPM system. Always replace tyres in accordance with recommendations. See **TYRE SPECIFICATIONS - ARDUOUS TERRAIN** (page 219).*

Wheels and tyres

Your vehicle may be equipped with a TPM System which monitors pressure in each tyre (temporary use spare wheels are not fitted with sensors and are consequently not monitored).

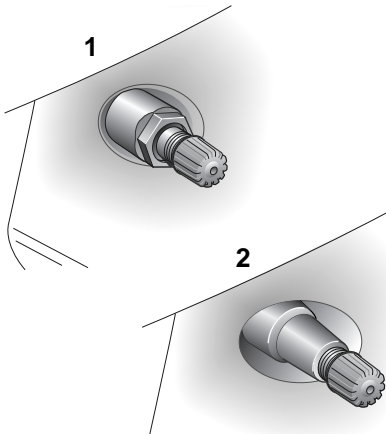

E91713

Wheels fitted with a TPM system can be easily visually identified by the external metal lock nut and valve (1). All Jaguar non-TPM system wheels have a rubber valve fitted (2).

TPM system operation

The TPM system monitors pressure of the tyres via sensors located in each wheel and a receiver within the vehicle.



The tyre pressure warning comprises a yellow warning telltale within the instrument panel, and the associated messages within the message centre.

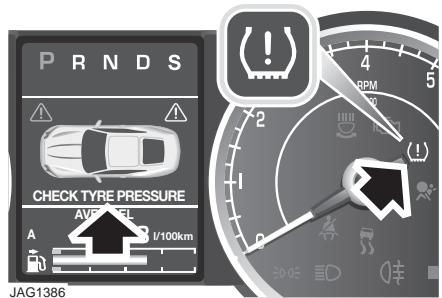

If the telltale light illuminates, you should stop and check your tyres as soon as possible and inflate them to the recommended pressure as stated on the tyre pressure placard fixed to the end of the left-hand side door. If low pressure warnings occur frequently, the cause must be determined and rectified.

When driving through variable climatic conditions the TPM system warnings may be intermittent.

Your vehicle will also indicate a TPM System malfunction by initially flashing and subsequent continuous illumination of the warning telltale. A text message will accompany the system malfunction and will display **TYRE PRESSURE SYSTEM FAULT**. The TPM system fault sequence will be activated at every ignition cycle until the fault is rectified. When a malfunction occurs, the system may not be able to detect or signal low tyre pressure as intended.

TPM system malfunctions may occur for a variety of reasons which may include other radio frequency systems that could cause interference or the installation of incompatible replacement tyres on the vehicle.

Wheels and tyres

Temporary use spare wheel and tyre change

If the temporary use spare wheel is fitted the system will automatically recognise the change in wheel positions. Then after approximately ten minutes of driving above 25 km/h (18 mph), a message **TYRE NOT MONITORED** will be displayed accompanied by illumination of the warning telltale and the corresponding block in the vehicle graphic.

The warning telltale will initially flash and will subsequently revert to continuous illumination. Extended use of the temporary use spare wheel will produce an additional text message **TYRE PRESSURE SYSTEM FAULT**.

This TPM system display sequence will be activated at every ignition cycle until the temporary use spare wheel is replaced by a fully operational full size wheel and tyre assembly.

Always replace the temporary use wheel before having TPM system faults investigated. The fault may well be rectified with the fitment of a fully operational full size running tyre in lieu of the temporary use spare wheel assembly.

Tyre changing

CAUTION



Valve stem seal, washer, nut, valve core and cap should be replaced at every tyre change. Valve stem seal, washer and nut must be replaced if valve retention nut is loosened. Sensor units and nuts must be refitted using correct torque figures and associated profile. Damage to the vehicle may result if these precautions are not taken.

Always have your tyres serviced or changed by a qualified engineer.

Care must be taken to avoid contact between the bead of the tyre and the sensor during removal and refitting of the tyre, otherwise the sensor may become damaged and or inoperable.

Sensors can be removed from the wheel by the unscrewing of the valve retention nut.

Replacement sensor

Should the sensor require replacing, it should be carried out by a Jaguar Dealer/Authorised Repairer.

A replacement sensor must be fitted to a running wheel in order to be recognised by the TPM system. Recognition only occurs when the vehicle is driven above 25 km/h (18 mph) for approximately ten minutes.

If the TPM system warning for any wheel does not clear, even after ensuring correct inflation and driving for more than ten minutes above 25 km/h (18 mph), you should seek qualified assistance as soon as possible.

Wheels and tyres

TPM System information messages

Message	Warning light	Priority indicator	Meaning
CHECK TYRE PRESSURE (Graphic indication displays which tyre is under-inflated.)	TPM System	Amber	You should stop as soon as possible, check your tyres and inflate them to the recommended pressure.
CHECK ALL TYRE PRESSURES	TPM System	Amber	May be displayed when the vehicle is learning that a new sensor is fitted to the vehicle and one or more tyres has low pressure. You should stop as soon as possible, check your tyres and inflate them to the recommended pressure.
TYRE PRESSURE SYSTEM FAULT	TPM System	Amber	1. The wheels do not have TPM System sensors fitted. 2. The TPM System sensors have become defective, an unapproved accessory is interfering with the system or a general fault has been detected. Seek qualified assistance as soon as possible.
TYRE NOT MONITORED (Graphic indication displays which tyre is not monitored.)	TPM System	Amber	1. A temporary use spare wheel is fitted. Vehicle speed should be limited to 80 km/h (50 mph). 2. A TPM System sensor has become defective, an unapproved accessory is interfering with the system or a wheel has been fitted that does not have a sensor. Seek qualified assistance as soon as possible.

Wheels and tyres

USING SNOW CHAINS

WARNING



Select JaguarDrive control Winter mode, with DSC switched on, when using snow chains.

CAUTION



Do not fit snow chains to 20 inch tyres.

Snow chains of the recommended type, can only be fitted to rear wheels. They should not be used on temporary use spare wheels.

You should contact your Jaguar Dealer/ Authorised Repairer for details and availability of approved snow chains.

The maximum speed when using snow chains is 48 km/h (30 mph).

Remove the snow chains immediately the roads are clear of snow.

Ensure the fitting instructions supplied with the snow chains are kept in a safe place (e.g. with this literature pack).

TYRE GLOSSARY

lbf/in² or psi

Pounds per square inch, an imperial unit of measure for pressure.

kPa

Kilo Pascal, a metric unit of measure for pressure.

Cold tyre pressure

The air pressure in a tyre which has been standing in excess of three hours, or driven for less than 1.6 km (1 mile).

Maximum inflation pressure

The maximum pressure to which the tyre should be inflated. This pressure is given on the tyre sidewall in lbf/in² (psi) and kPa.

Note: *This pressure is the maximum allowed by the tyre manufacturer. It is not the pressure recommended for use.*

Kerb weight

The weight of a standard vehicle, including a full tank of fuel, any optional equipment fitted, and with the correct coolant and oil levels.

Gross vehicle weight

The maximum permissible weight of a vehicle with driver, passengers, load, luggage, equipment, and towbar load.

Accessory weight

The combined weight (in excess of those items replaced) of items available as factory installed equipment.

Production options weight

The combined weight of options installed which weigh in excess of 1.4 kg (3 lb.) more than the standard items that they replaced, and are not already considered in kerb or accessory weights. Items such as heavy duty brakes, high capacity battery, special trim etc.

Vehicle capacity weight

The number of seats multiplied by 68 kg (150 lb.) plus the rated amount of load/luggage.

Maximum loaded vehicle weight

The sum of kerb weight, accessory weight, vehicle capacity weight, plus any production option weights.

Rim

The metal support for a tyre, or tyre and tube, upon which the tyre beads are seated.

Wheels and tyres

Bead

The inner edge of a tyre that is shaped to fit to the rim and form an airtight seal. The bead is constructed of steel wires which are wrapped, or reinforced, by the ply cords.

TYRE SPECIFICATIONS - ARDUOUS TERRAIN

In certain markets, due to the possibility of very uneven or unmetalled roads, it is necessary to fit tyres suitable for the conditions. These markets and the relevant tyre specification are detailed below.

The following chart details the tyres recommended for use in the countries listed below:

- A.** Australia, Bahrain, Egypt, Israel, Jordan, Kuwait, Lebanon, Malaysia, Mexico, Morocco, Oman, Qatar, Saudi Arabia, South Africa, Syria, Thailand, United Arab Emirates.
- B.** Argentina, Belarus, Brazil, Bulgaria, Chile, Dominican Republic, Estonia, Guatemala, Indonesia, Kazakhstan, Panama, Philippines, Russia, Sri Lanka, Ukraine, Uzbekistan.

Wheel position	Tyre size	Pattern	A	B
Front	245/45ZR18 100Z	Continental Sport Contact 2 Asymmetric	yes	yes
Rear	275/40ZR18 103Z	Continental Sport Contact 2 Asymmetric	yes	yes
Front	245/40ZR19 94Y	Dunlop Sport 01 Asymmetric	yes	yes
	245/40ZR19 98Y	Pirelli P-Zero Rosso	yes	yes
Rear	275/35ZR19 96Y	Dunlop Sport 01 Asymmetric	yes	yes
	275/35ZR19 100Y	Pirelli P-Zero Rosso	yes	yes
Front	255/35ZR20 97Y	Dunlop Sportmaxx Directional	yes	yes
Rear	285/30ZR20 99Y	Dunlop Sportmaxx Directional	yes	yes
Temporary use spare wheel (front and rear):				
Alloy 4 x 18	T135/80 R18	Pirelli	yes	yes
Alloy 4 x 19	T135/70 R19	Pirelli	yes	yes

For all other countries, you should refer to your local Jaguar Dealer/Authorised Repairer for specific tyre fitment.

Fuses

CHANGING A FUSE

CAUTIONS

- ! Always turn off the ignition system and the affected electrical circuit, before replacing a fuse.
- ! Fit Jaguar approved replacement fuses of the same rating and type, or fuses of matching specification. Using an incorrect fuse may result in damage to the vehicle's electrical system, and can result in a fire.
- ! If the replacement fuse blows after installation, the system should be checked by your Jaguar Dealer/Authorised Repairer.
- ! No attempt should be made to repair a fuse that has blown.

Note: Jaguar recommend that owners do not remove or replace relays. It is recommended that you seek qualified assistance in the event of a relay failure.

Always switch off the ignition and the affected electrical circuit, before replacing a fuse.

Fuse failure is identified by an inoperative circuit.

A special tool for removing and replacing Mini and ATO-fuses is provided in the passenger and rear seat compartment fuse boxes, together with spare fuses.

Four types of fuses are fitted in the fuse boxes: If a spare fuse is used, renew it with a fuse of the same amperage rating.

Push the tool onto the suspect fuse and withdraw it.

If the wire in the fuse is broken, the fuse has blown.

Fit a new fuse using the tool.

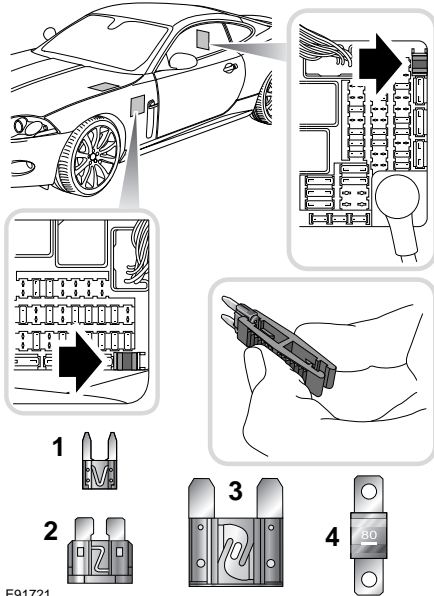

1. Mini-type
2. ATO-type
3. Maxi-type
4. Midi-type.

Checking or renewing a blown fuse

Fuse types **3** and **4** and relays should be replaced only by qualified personnel.

Fuses are colour coded according to the amperage and the rating is also marked on each fuse.

Fuses

FUSE BOX LOCATIONS

CAUTION

⚠ When a fuse box lid is removed, take care to protect the box from moisture, and refit the lid at the earliest opportunity.

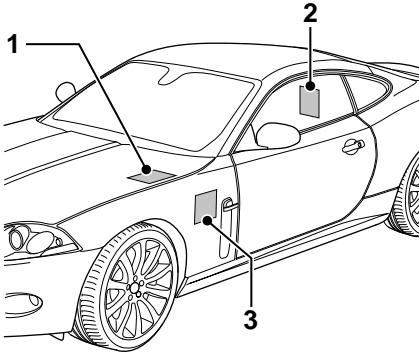

E91723

There are three separate fuse boxes fitted to the vehicle, each one containing fuses protecting a different group of circuits.

They are located in:

1. The engine compartment
2. The rear seat compartment
3. The passenger compartment.

Engine compartment fuse box

The fuse box is located in the engine compartment on the left-hand side underneath the engine compartment left-hand cover.

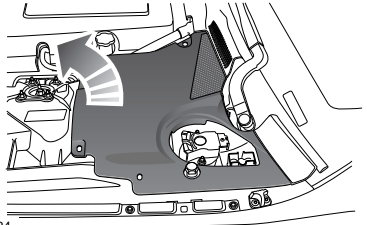
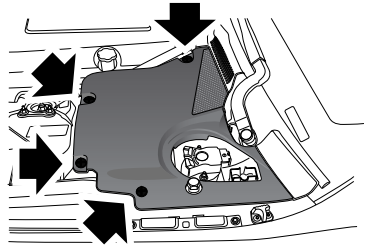
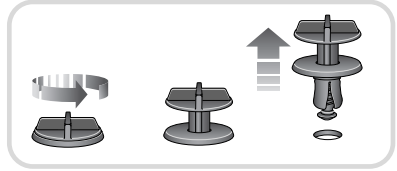

E91724

Remove the engine compartment left-hand cover.

Fuses

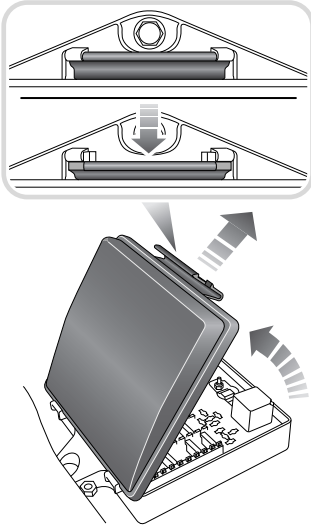

E91725

Remove the fuse box lid by pressing the retaining lugs and lifting.

When refitting, press the fuse box lid in the area of the retaining lugs until the lid engages.

Rear seat compartment fuse box

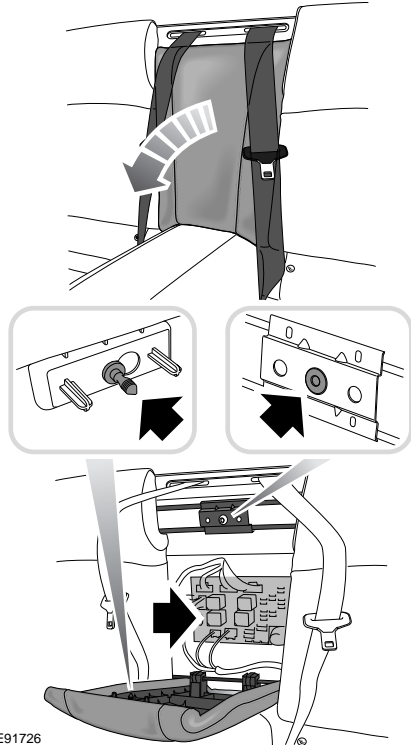

E91726

A fuse box is located behind the rear seat centre section.

To remove the rear seat centre section, grasp the sides of the section and pull sharply.

When refitting the rear seat centre section ensure that the securing and locating pegs are aligned with their respective holes before pushing the centre section fully home.

Fuses

Passenger compartment fuse box

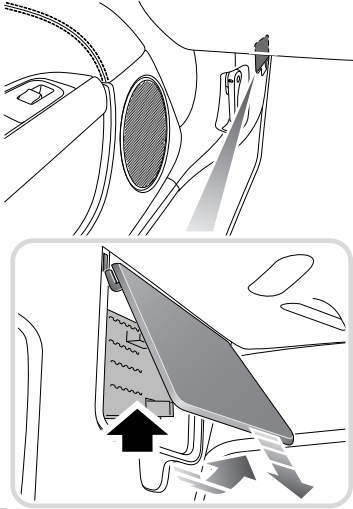

E91727

The passenger compartment fuse box is located under the left-hand side trim panel in the footwell.

To access the fuse box remove the left-hand side trim panel fuse box cover.

Fuses

Fuse and relay positions

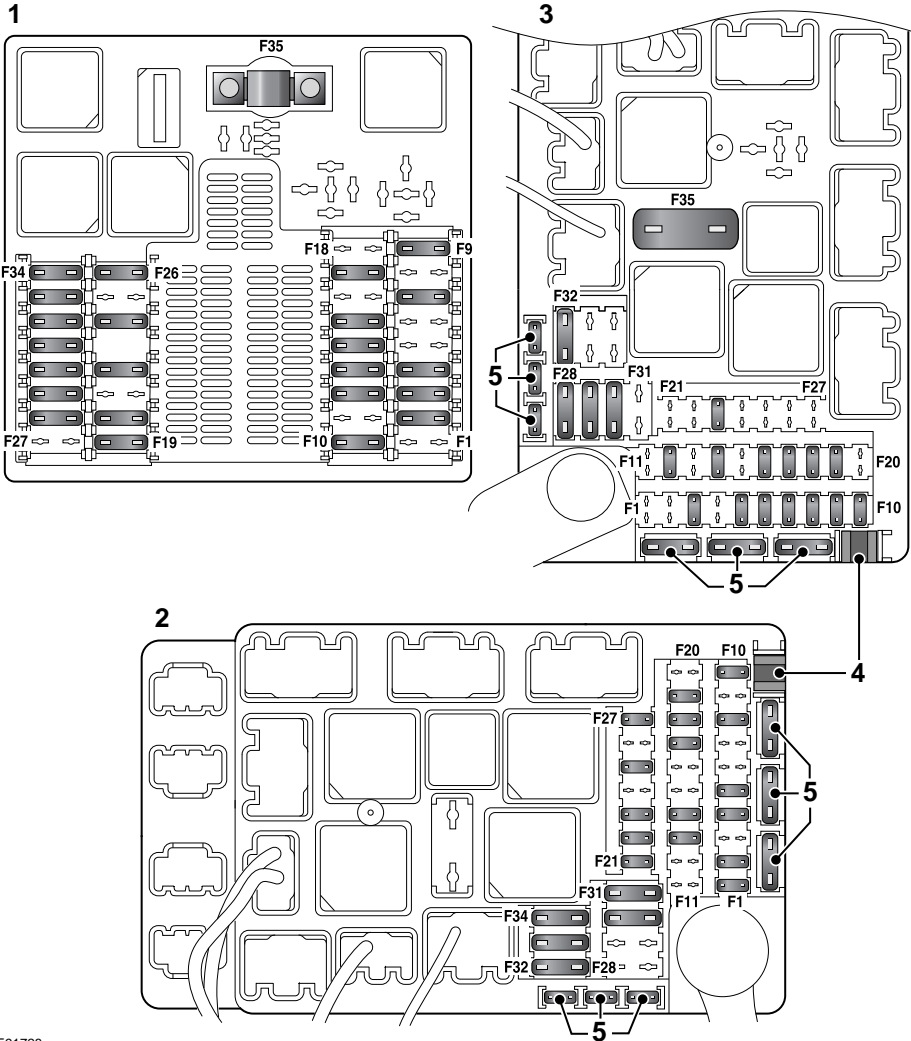

E91728

1. Engine compartment fuse box.
2. Rear seat compartment fuse box.
3. Passenger compartment fuse box.
4. Fuse removal tool.
5. Spare fuses.

Fuses

FUSE SPECIFICATION CHARTS

Engine compartment fuse box

Fuse No	Rating (amps)	Fuse Colour	Circuit
F1	-	-	Not used.
F2	15A	Blue	Adaptive front lighting system - LH.
F3	5A	Tan	DSC ECU.
F4	30A	Green	Powerwash pump.
F5	-	-	Not used.
F6	-	-	Not used.
F7	40A	Orange	Front left screen heater.
F8	-	-	Not used.
F9	15A	Blue	Cigar lighter heater element.
F10	15A	Blue	Horn.
F11	-	-	Not used.
F12	10A	Red	Headlamp levelling, Cluster VAPS.
F13	15A	Blue	Adaptive front lighting system - RH.
F14	15A	Blue	Ignition coils.
F15	10A	Red	ACC.
F16	-	-	Not used.
F17	15A	Blue	TCM, ECM memory.
F18	20A	Yellow	EMS main, EMS secondary control.
F19	30A	Green	Starter.
F20	40A	Orange	DSC pump.
F21	-	-	Not used.
F22	20A	Yellow	DSC valves.
F23	-	-	Not used.
F24	15A	Blue	Intercooler water pump.
F25	-	-	Not used.
F26	40A	Orange	Wiper motor.
F27	-	-	Not used.
F28	15A	Blue	ECM, VVT diode.
F29	5A	Tan	Oil quality, MAFS, DHTL.
F30	10A	Red	Throttle motor.

Fuses

Fuse No	Rating (amps)	Fuse Colour	Circuit
F31	10A	Red	Radiator fan, ECM cooling fan.
F32	40A	Orange	Front right screen heater.
F33	30A	Green	UHEGO - A bank heaters.
F34	30A	Green	UHEGO - B bank heaters.
F35	80A 100A	Black Black	Radiator fan - Normally aspirated engines. Radiator fan - Supercharged engines.

Rear seat compartment fuse box

Fuse No	Rating (amps)	Fuse Colour	Circuit
F1	25A	Clear	Passenger door zone ECM.
F2	5A	Tan	Tyre Pressure Monitoring System.
F3	-	-	Not used.
F4	-	-	Not used.
F5	-	-	Not used.
F6	-	-	Not used.
F7	-	-	Not used.
F8	5A	Tan	Power roof logic.
F9	-	-	Not used.
F10	10A	Red	Accessory connector B+.
F11	-	-	Not used.
F12	-	-	Not used.
F13	25A	Clear	Driver's door zone ECM, OBD2.
F14	10A	Red	Navigation, VICS, power.
F15	-	-	Not used.
F16	-	-	Not used.
F17	10A	Red	Restraints control module, Instrument pack, Occupancy classification sensor.
F18	30A	Green	Electric Parking Brake (EPB).
F19	10A	Red	Supercharged active exhaust.
F20	-	-	Not used.
F21	15A	Blue	IHU, supply (IAV, ICM, ICP).

Fuses

Fuse No	Rating (amps)	Fuse Colour	Circuit
F22	5A	Tan	Phone, VEMS, power.
F23	30A	Green	Heated rear screen.
F24	10A	Red	AUU.
F25	10A	Red	DVD, power.
F26	-	-	Not used.
F27	10A	Red	Pedestrian impact sensor.
F28	40A	Orange	E-Diff.
F29	-	-	Not used.
F30	40A	Orange	Power roof rear quarters.
F31	30A	Green	Power Amp supply.
F32	40A	Orange	Power roof supply.
F33	30A	Green	Fuel pump module.
F34	40A	Orange	Blower motor.

Passenger compartment fuse box

Fuse No	Rating (amps)	Fuse Colour	Circuit
F1	20A	Yellow	Climate seats.
F2	10A	Red	ETS, Electric Parking Brake logic.
F3	20A	Yellow	Keyless vehicle module.
F4	20A	Yellow	Climate seats.
F5	5A	Tan	Instrument panel logic.
F6	15A	Blue	Air conditioning.
F7	5A	Tan	Passive Anti-Theft System (PATS) transmitter/receiver.
F8	5A	Tan	Foot brake switch.
F9	5A	Tan	Passenger seat memory switch, Passenger seat module, Sunload sensor.
F10	15A	Blue	Instrument panel (column adjust).
F11	-	-	Not used.
F12	10A	Red	Interior lamp switched power comprises - map, courtesy, footwell, sun visor, glove box. In-car aspirator.
F13	-	-	Not used.

Fuses

Fuse No	Rating (amps)	Fuse Colour	Circuit
F14	15A	Blue	Adaptive dynamic ride control power.
F15	-	-	Not used.
F16	15A	Blue	Front power point, premium audio amplifier, cooling fan.
F17	5A	Tan	OBD II.
F18	5A	Tan	Driver's seat module, Singapore Road Pricing, Driver's seat memory, Driver's window and mirror switchpack.
F19	5A	Tan	RF receiver.
F20	-	-	Not used.
F21	-	-	Not used.
F22	-	-	Not used.
F23	10A	Red	Cabin accessory power.
F24	-	-	Not used.
F25	-	-	Not used.
F26	-	-	Not used.
F27	-	-	Not used.
F28	30A	Green	Passenger seat motor (2).
F29	30A	Green	Passenger seat motor (1).
F30	30A	Green	Driver's seat module (1).
F31	-	-	Not used.
F32	30A	Green	Driver's seat module (2).
F33	-	-	Not used.
F34	-	-	Not used.
F35	-	-	Not used.

Emergency equipment

HAZARD WARNING FLASHERS

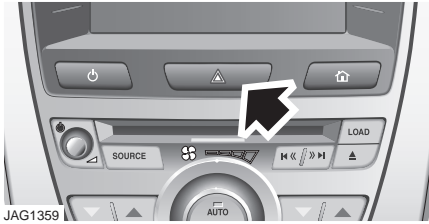

If the vehicle is stationary in an unsafe location, or may cause a hazard to other road users, switch on the hazard warning flashers. Press the switch to turn the hazard warning lamps on.

Note: Hazard warning lamps can be used when the ignition is on or off.

WARNING TRIANGLE

A warning triangle, designed to international standards, is standard equipment in some countries.

The warning triangle is mounted under the luggage compartment load floor.

In an emergency, remove the triangle and unfold its stand legs. Place the triangle in the road in accordance with local traffic regulations to give oncoming traffic warning of an immobilised vehicle.

Hazard warning flashers must be used with the warning triangle.

FIRE EXTINGUISHER

WARNING



Do not use a fire extinguisher closer than 2.4 m (8 feet) to the base of a liquid fire as the force may splatter the burning liquid to the surrounding area.

Dealer fitted fire extinguisher

Your Jaguar Dealer can supply and fit one.

Factory fitted fire extinguisher

The factory fitted fire extinguisher contains BC powder pressurised with nitrogen to a working pressure of 12 bar (180 lbf/in²/120 kPa) at 20°C (68°F).

This extinguisher can be used on liquid fires, electrical equipment fires and, if no explosion risk, gasoline fires.

To operate the fire extinguisher, follow the instructions as stated on the extinguisher.

Do not test the fire extinguisher prior to use. Partial discharge will render the extinguisher inoperative.

Maintenance

Every six months:

- Remove the extinguisher from its bracket and check that the nozzle is clear.
- Check that any fitted safety devices are secure.
- If fitted, check pressure gauge is reading within limits. If the gauge is indicating incorrect limits the extinguisher may not work in an emergency. Seek qualified assistance immediately.

FIRST AID KIT

Your Jaguar Dealer/Authorised Repairer can supply a first aid kit.

Status after a collision

DRIVING AFTER A COLLISION

Before starting or driving

WARNING



If the vehicle is involved in a collision it should be checked by a Jaguar Dealer/Authorised Repairer, or suitably qualified persons, before starting or driving.

If the vehicle is involved in a collision, the functionality could be reduced.

Depending upon the severity of the collision the following vehicle functions may come into effect:

- Engine shut down.
- Inertia switch tripped, which cuts off the fuel pump.
- Doors unlock.
- Hazard and interior lamps come on (the hazard lamps will remain on until the inertia switch is reset).
- The message centre will display **INERTIA SWITCH TRIPPED**.
- Exterior lamps will maintain their state.

ATTEMPTING TO START THE VEHICLE

WARNING



To reduce the risk of fire or personal injury, do not under any circumstances, attempt to start the vehicle if you see or smell fuel.

The inertia switch may have been tripped by the collision. This will cut off the fuel pumps. The switch must be reset before the engine will start.

Resetting the switch

If no fuel leak is apparent:

1. Press the engine START/STOP button, without pressing the brake pedal, to turn the ignition to convenience mode (ignition off). Wait for approximately 10 seconds.
2. Press the engine START/STOP button again, without pressing the brake pedal, to turn the ignition on. Wait 30 seconds.
3. Make a further check for fuel leaks.
4. Press the START/STOP button with the brake pedal depressed to start the engine.

MOVING THE VEHICLE

If the engine starts, the vehicle may be moved carefully to a position of safety. Do not move the vehicle further than necessary.

Recovery

Even if the vehicle appears driveable after the collision, it should not be driven or towed. Concealed damage could make the vehicle impossible to manoeuvre. See

TRANSPORTING THE VEHICLE (page 232).

Status after a collision

INSPECTING SAFETY SYSTEM COMPONENTS

WARNING



It is not recommended that the vehicle be driven or used, until all of the occupant protection systems have been checked.

Following a collision, the seat belt and Advanced Restraints Technology System (ARTS) components should be inspected for damage and or deformity. The inspection and any subsequent repair work should only be carried out by a Jaguar Dealer/Authorised Repairer, or other suitably qualified persons.

Components which require inspection include:

- Seat belt webbing and mechanisms.
- Seat belt pre-tensioners.
- Airbag covers and modules.
- Seat frames and mounting points.
- Child seats.
- Child seat anchor points.

Note: *This list is not exhaustive.*

In addition to the physical items checked, the electronic control system and its associated wiring should also be checked thoroughly. This process will include a diagnostic check which can only be carried out by a Jaguar Dealer/ Authorised Repairer or suitably qualified and equipped persons.

Vehicle recovery

TRANSPORTING THE VEHICLE

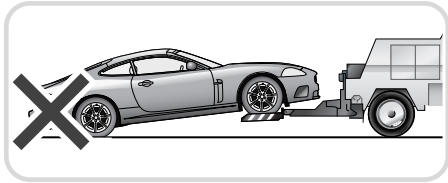
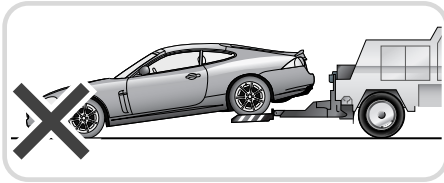
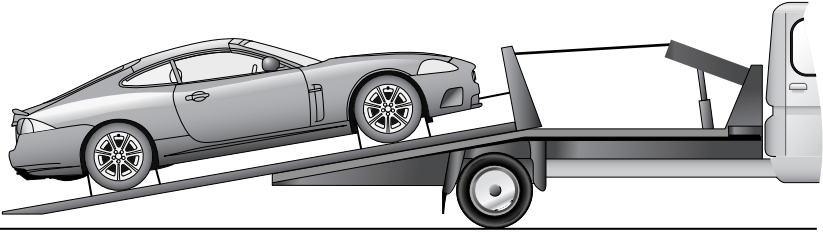

E91737

The recommended method for recovery/transportation of the vehicle, is on a transporter or trailer designed for that purpose.

Ensure that transportation is carried out by suitably qualified persons and that the vehicle is secured correctly.

CAUTIONS

- ⚠ Ensure that the recovery team do not tow with sling-type, spectacle-type or towing dolly equipment as damage to the front or rear underside bodywork may result.
- ⚠ Only use over-wheel/tyre tie-downs over the front wheels, to secure the vehicle to the transporter or trailer. Use of any other position (e.g. lower control arms, towing eyes) may result in damage to the vehicle.
- ⚠ The vehicle must be towed with the rear wheels clear of the ground, to prevent damage to the transmission.

When the vehicle is transported, the parking brake must be applied, the wheels chocked and the Emergency Park Release (EPR) operated. EPR ensures that the transmission remains in **N** and does not automatically select **P**.

While the vehicle is being loaded, the Jaguar Smart Key should be placed in the starter control unit. This will prevent the steering lock activating.

Use straps on the front wheels and tyres to secure the vehicle to the transporter or trailer.

The towing eye is not designed for securing the vehicle during transportation.

Vehicle recovery

EMERGENCY PARK RELEASE (EPR)

When recovering your vehicle, it is essential that the EPR is operated. EPR prevents the transmission from automatically selecting **P**, ensuring that the transmission remains in neutral (**N**). EPR is operated by a lever located beneath a trim panel in the cubby box. Before activating EPR, select **P**, apply the parking brake and turn the ignition off.

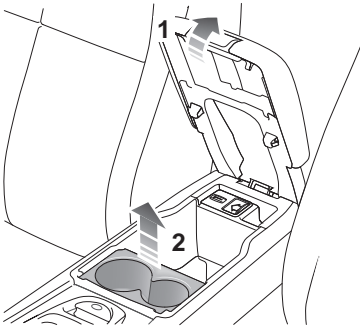

JAG1426

1. Open the cubby box lid.
2. Remove the twin cup holder.
3. Using an appropriate screwdriver, unscrew and remove the screw securing the trim panel, where shown. Store the screw in a safe place.

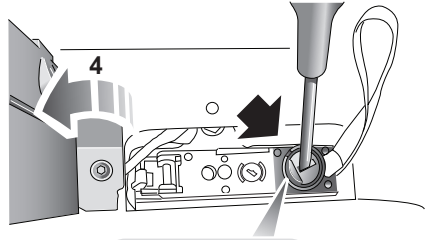
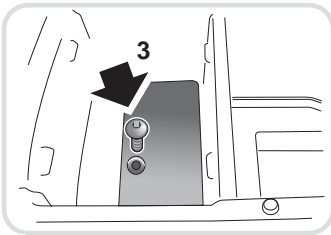

JAG1427

4. Lift the right-hand edge of the trim panel to open.
5. Using a flat-bladed screwdriver, turn the locking device 90° counter-clockwise.

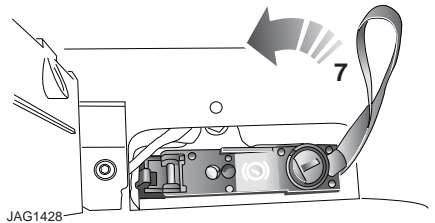
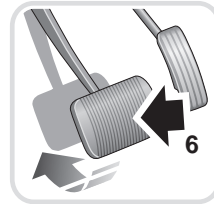
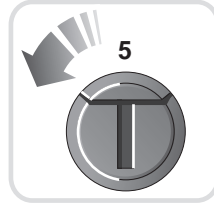

JAG1428

6. Apply the foot brake.
7. Use the strap to pull the EPR lever upwards, until it latches in the vertical position.

Vehicle recovery

When the EPR is activated, the JaguarDrive selector will remain in **P**, but the selector indicator and the gear display in the message centre will both flash **N** (if ignition is on), to indicate that EPR is active.

labelling Cancellling EPR

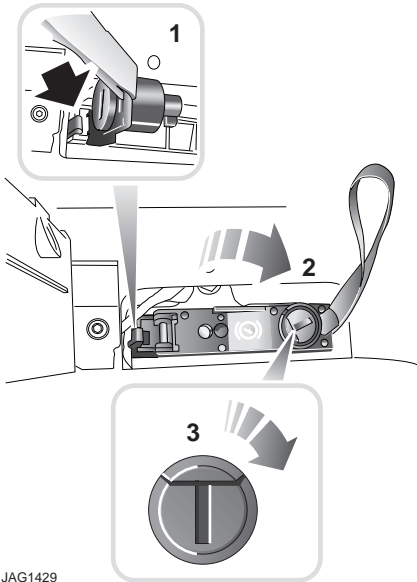

JAG1429

1. Using a flat-bladed screwdriver, release the latch (arrowed).
2. Return the EPR lever to its horizontal position.
3. Turn the locking device 90° clockwise to secure.

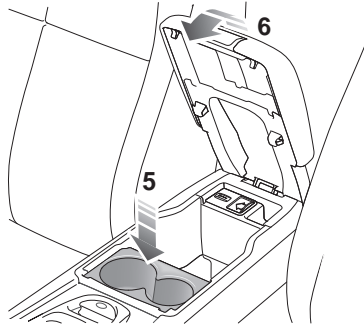
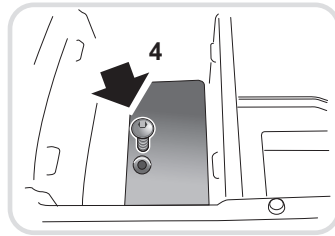

JAG1430

4. Lower the trim panel and secure with the screw.
5. Replace the twin cup holder.
6. Close the cubby box.

Vehicle recovery

TOWING POINTS

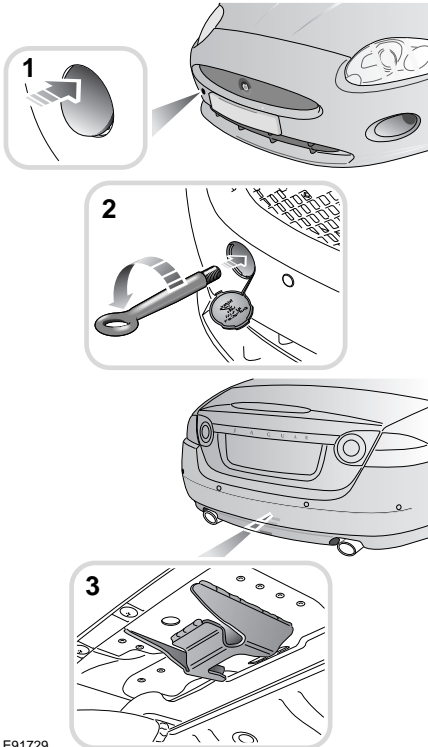

E91729

WARNING



Avoid contact with a hot exhaust when fitting equipment to the rear towing point.



The towing points at the front and rear of the vehicle, are designed for on-road recovery only. If they are to be used for any purpose other than those indicated, it may result in vehicle damage and serious injury.

WARNING



Never use the towing eyes to tow a trailer, caravan etc. Doing so may result in vehicle damage and serious injury.

CAUTIONS



Care must be taken to avoid damaging the bumpers and front apron.



The towing eye is not suitable for solid bar towing.

Attaching the front towing eye

A screw-in front towing eye is provided with the tool kit, located beneath the luggage compartment. The towing eye must be turned in a counterclockwise direction when fitting.

The front towing point is located behind a plastic cover on the left-hand side of the vehicle (as viewed from the front).

1. To access the towing point, press the plastic cover on the top to unclip. Remove the cover.
2. Screw the towing eye counterclockwise into the vehicle, right up to the shoulder.
3. The rear towing point is in the centre of the vehicle, to the rear of the exhaust silencer. Use this point only when the vehicle is to be towed rearwards on straight level ground for the least amount of distance possible, or when loading onto a recovery vehicle.

Vehicle recovery

TOWING ON FOUR WHEELS

WARNING



Ensure that the Jaguar Smart Key remains docked whilst the vehicle is being towed. Removing the Smart

Key will engage the steering lock, preventing the vehicle from being steered correctly.



If the engine cannot be run whilst the vehicle is being towed, there will be no power assistance for the steering

or brakes. This will result in greater effort being required to steer or slow the vehicle and greatly increased stopping distances.

CAUTIONS



The vehicle should only be towed in a forward direction with all four wheels on the ground.



The vehicle should only be towed for a maximum of 0.8 km (0.5 miles), at a maximum speed of 48 km/h (30 mph). Towing for a greater distance or at a higher speed, may result in serious damage to the transmission.

Note: *The recommended recovery method is to raise all four wheels and transport on a transporter or trailer designed for that purpose.*

The removable towing eye is primarily for emergency use when towing for short distances, e.g. removing the vehicle if causing an obstruction or when winching onto a recovery transporter.

When being towed, the ignition system should be switched to convenience mode, to release the steering lock and render the indicators, horn and brake lamps operational.

Towing procedure

1. The vehicle should be parked on firm, level ground, with the parking brake on and the gear selector in **P** (Park).

2. Secure the towing attachment from the recovery vehicle to the front towing eye. See **TOWING POINTS** (page 235).
3. Dock the Jaguar Smart Key and switch on the ignition. See **GENERAL INFORMATION** (page 131).

CAUTIONS



Leaving the ignition switched on for extended periods will cause the battery to drain.

4. Apply the foot brake and release the parking brake.
5. With the foot brake still applied, activate the Emergency Park Release (EPR). See **EMERGENCY PARK RELEASE (EPR)** (page 233).
6. The vehicle can now be towed a maximum of 0.8 km (0.5 miles), at a maximum speed of 48 km/h (30 mph).
7. Upon arrival at the destination, ensure wherever possible that the vehicle is parked on firm level ground.
8. Lower the EPR lever to re-engage **P** (Park). See **EMERGENCY PARK RELEASE (EPR)** (page 233).
9. Apply the parking brake.
10. Switch off the ignition and undock the Jaguar Smart Key.

WARNING



Use extreme caution when detaching towing equipment. Vehicle movement is possible which can result in serious injury.

11. Remove the towing attachment from the towing eye.

Vehicle identification

VEHICLE CERTIFICATION LABEL

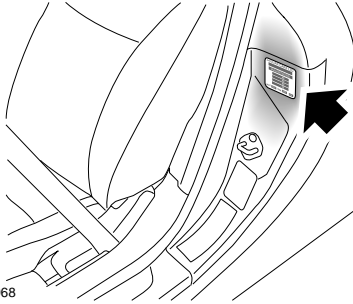

E91968

Vehicles have the Certification Label adhered to the left-hand rear door post (right-hand rear door post China only). Vehicle weights, paint code, manufacture date and the Vehicle Identification Number (VIN) are shown on this plate.

VEHICLE IDENTIFICATION NUMBER (VIN)

It is essential that the Vehicle Identification Number (VIN) is quoted in all correspondence and when ordering replacement parts.

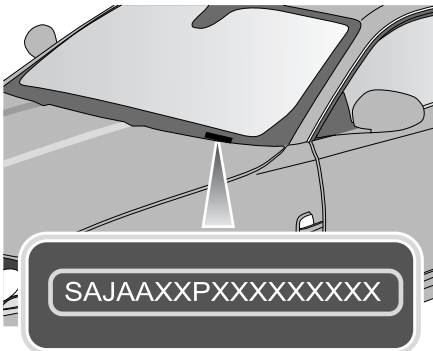

E91967

The number is visible from outside the vehicle, on a plate in the lower left-hand edge of the windscreen.

ENGINE NUMBER

The number is located on the front of the right-hand cam cover. To access the number, it is necessary to remove the engine covers. For further information or assistance, contact your Dealer/Authorised Repairer.

TRANSMISSION NUMBER

The number is etched on a plinth, on the side of the transmission casing.

VEHICLE BUILT DATE

(Australia only)

This is the calendar month and year in which the body and powertrain assemblies were conjoined and the vehicle was driven from the production line. The build date is shown on a plate located at the top of the battery tray in the luggage compartment.

The vehicle built date is stamped onto a plate in the engine compartment.

Technical specifications

ENGINE SPECIFICATIONS

	5.0 V8 normally aspirated	5.0 V8 supercharged
Capacity	5000 cm ³ (305 inch ³)	5000 cm ³ (305 inch ³)
Bore	92.5 mm (3.64 inch)	92.5 mm (3.64 inch)
Stroke	93 mm (3.66 inch)	93 mm (3.66 inch)
Compression ratio	11.5:1	9.5:1

WEIGHTS

	V8 5.0 normally aspirated		V8 5.0 supercharged	
	Coupe	Convertible	Coupe	Convertible
Kerb weight (no options fitted)	1595 kg (3516 lb.)	1635 kg (3605 lb.)	1665 kg (3671 lb.)	1715 kg (3781 lb.)
Front axle kerb weight	850 kg (1874 lb.)	852 kg (1879 lb.)	900 kg (1984 lb.)	909 kg (2004 lb.)
Rear axle kerb weight	745 kg (1642 lb.)	783 kg (1726 lb.)	765 kg (1687 lb.)	806 kg (1777 lb.)
Gross Vehicle Weight (GVW) ¹	2035 kg (4486 lb.)	2075 kg (4575 lb.)	2080 kg (4586 lb.)	2120 kg (4647 lb.)
Gross front axle weight	1015 kg (2238 lb.)	1020 kg (2249 lb.)	1050 kg (2315 lb.)	1050 kg (2315 lb.)
Gross rear axle weight	1090 kg (2403 lb.)	1125 kg (2480 lb.)	1095 kg (2414 lb.)	1130 kg (2491 lb.)
Maximum luggage compartment load with passenger and driver	28 kg (62 lb.)	28 kg (62 lb.)	28 kg (62 lb.)	28 kg (62 lb.)

Note: The maximum permitted luggage compartment load can be exceeded, provided the requirements regarding the maximum permissible axle weights and tyre pressures are followed.

¹ GVW = the maximum permissible weight of the vehicle, including all passengers and load.

Technical specifications

DIMENSIONS

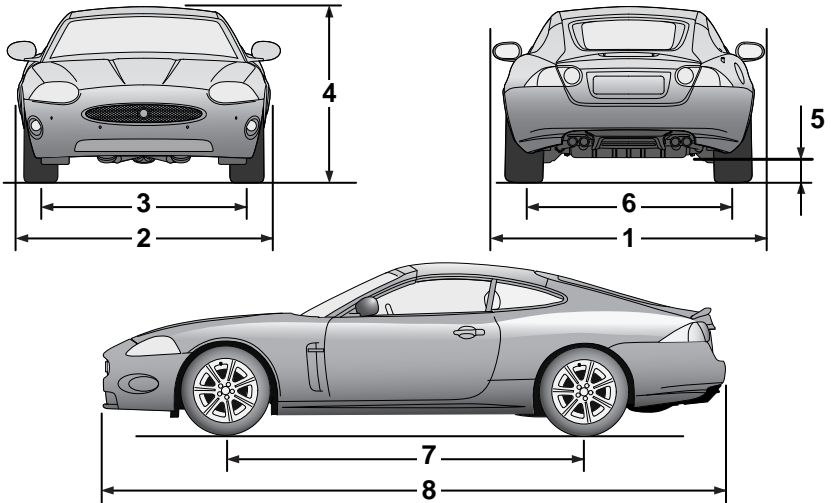

E91982

Item	Description		
1	Overall width, mirrors extended	2070 mm	81.5 in.
2	Overall width, mirrors folded	1892 mm	74.5 in.
2	Overall width, mirrors folded, rear arch extensions fitted	1912 mm	75.3 in.
3	Track - Front (maximum)	1560 mm	61.0 in.
4	Overall height at GVW (nominal) - Coupe	1287 mm	50.6 in.
4	Overall height at GVW (nominal) - Convertible	1294 mm	51.0 in.
5	Minimum ground clearance (at GVW)	100 mm	4.0 in.
6	Track - rear (maximum)	1608 mm	63.3 in.
7	Wheelbase	2752 mm	108 in.
8	Overall length	4782 mm	188 in.
-	Turning circle (kerb to kerb)	10.97 m	37.4 ft

Technical specifications

WHEEL ALIGNMENT DATA (CHINA ONLY)

Front

	Left-hand side		Right-hand side	
	Min	Max	Min	Max
Camber	-1° 09'	+0° 21'	-1° 21'	+0° 09'
Castor	+6° 02'	+7° 32'	+6° 02'	+7° 32'
	Min		Max	
Toe (total)	-0° 02'		+0° 22'	

Rear

	Left-hand side		Right-hand side	
	Min	Max	Min	Max
Camber	-1° 20'	+0° 10'	-1° 20'	+0° 10'
Castor	Non-adjustable		Non-adjustable	
	Min		Max	
Toe (total)	+0° 03'		+0° 27'	

Note: All above figures are with the vehicle at kerb weight (full fuel, full fluids, no occupants or luggage).

Note: Tyre pressures must be inflated to normal pressure settings.

Audio introduction

RADIO RECEPTION

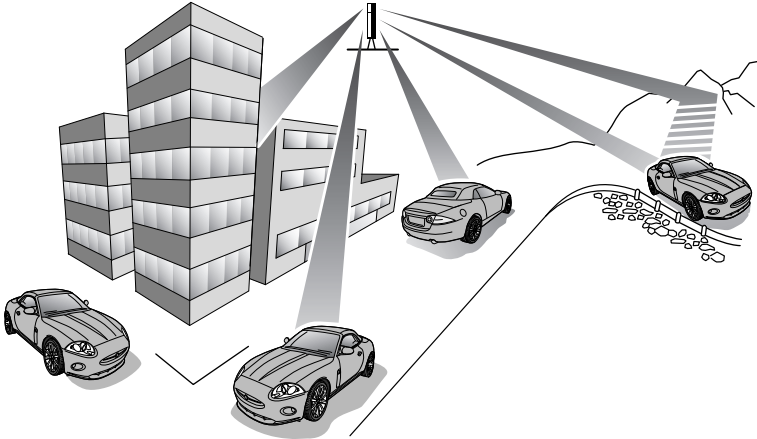

E92305

Your radio receives signals whilst on the move, and may experience widely differing reception characteristics. Because of this, some interference is to be expected from time to time during a journey.

FM transmitters can only broadcast over a limited range, and good clear signals will only be received in the immediate area of the transmitter. When travelling, occasionally it may be necessary to re-tune the radio to offset the effects of moving from one transmitter area to another.

While RDS automatic re-tuning helps to reduce the effects of signal changes, some manual re-tuning may still be required (especially for local stations) in areas of weak reception.

The broadcast range for good stereo reception is within approximately 48 - 64 km (30 - 40 miles) of the transmitter.

FM Signals travel in a straight line, so large obstacles, such as tall buildings, can shield the car from the signal causing distortion or loss of reception (known as dead spots).

Distortion can also occur if FM signals received directly from the transmitter, mix with signals deflected by obstructions such as mountains, hills, and tall buildings. This is known as multi-path distortion.

Note: Although distortion, interference and lack of signal clarity are sometimes attributed to a fault in the radio, this is rarely the case.

Audio unit overview

AUDIO UNIT OVERVIEW

The Jaguar infotainment system includes AM/FM radio, compact disc player and portable audio interface. Digital (DAB) radio and the six-disc CD player are optional.

WARNING



Sustained exposure to high sound levels can damage your hearing.



JAG1570

The Audio unit is controlled by the touch-screen (1) and console buttons (2 - 8).

- 1. Touch-screen:** See **PERSONALISED SETTINGS** (page 103).
- 2. LOAD:** Press to load CD. See **LOADING COMPACT DISCS** (page 270).
- 3. Eject:** Press to eject CD. See **EJECTING COMPACT DISCS** (page 272).
- 4. Seek up:** Press to seek next station frequency up or next CD track.
- 5. Seek down:** Press to seek next radio frequency down or previous CD track.
- 6. SOURCE:** Press repeatedly to scroll through all audio sources: FM1, FM2, AM, DAB1, DAB2, DAB3, CD and Portable audio.

- 7. Audio system on/off and volume:** Press to switch the system on/off.

Volume control: Rotate to increase or decrease volume level. Any volume setting made in any mode, will be memorised for that mode.

- 8. CD load and eject slot.**

CAUTION



Care must be taken to avoid spilling or splashing drinks onto the audio unit controls, speakers or touch-screen. In the event of such an occurrence, contact your Dealer/Authorised Repairer.



The audio unit may be damaged if unsuitable items, such as coins or credit cards, are inserted into the CD load slot.

Audio unit overview

Steering wheel controls

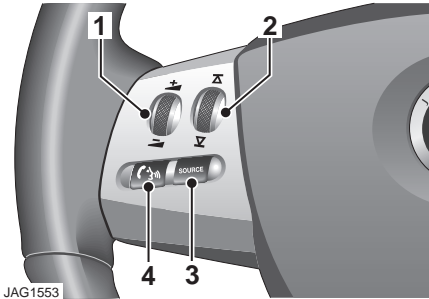

1. Rotate up or down to Increase or decrease volume.
2. Rotate up or down and release repeatedly, to scroll through preset radio stations or CD tracks. Rotate up and hold for two seconds to select the next strong radio station or next loaded CD (if a six-disc system is fitted).
3. **SOURCE:** Press repeatedly to scroll through all audio sources.
4. Press to mute audio unit. This button is also used to start, answer or end calls in phone mode.

Sound system overview

- The standard Jaguar Sound System comprises a radio, in-dash CD player (six-disc optional), door mounted speakers and additional speakers in the rear quarters.
- The Jaguar Premium Sound System also includes upgraded speakers mounted in the doors and rear quarters, plus an additional speaker mounted in the fascia and a sub-woofer mounted in the passenger foot well under the carpet. This speaker configuration allows the reproduction of audio in stereo, 3-channel or Dolby Pro Logic II Surround Sound™.

Radio system display panel (in AM-FM mode)

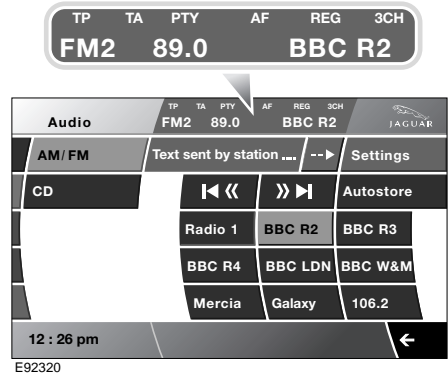

TP	Traffic Programme.
TA	Traffic Announcement selected.
PTY	Priority Programme Type selected.
AF	Alternative Frequency.
REG	Regionalisation.
DPL II, 3CH	Surround mode - Dolby Pro Logic II or 3CH.
FM2	Frequency channel selected.
89.0	Frequency of selected station.
BBC R2	Radio station selected.

Audio unit overview

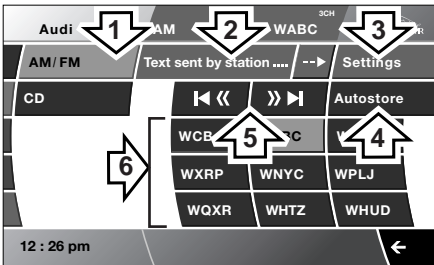

E93911

1. **AM/FM band switching.**
2. **Radio text sent by radio station.**
3. **Settings.**
4. **Autostore.**
5. **Seek up and Seek down.**
6. **Preset memorised radio stations.**

Audio unit overview

Touch-screen audio flow chart

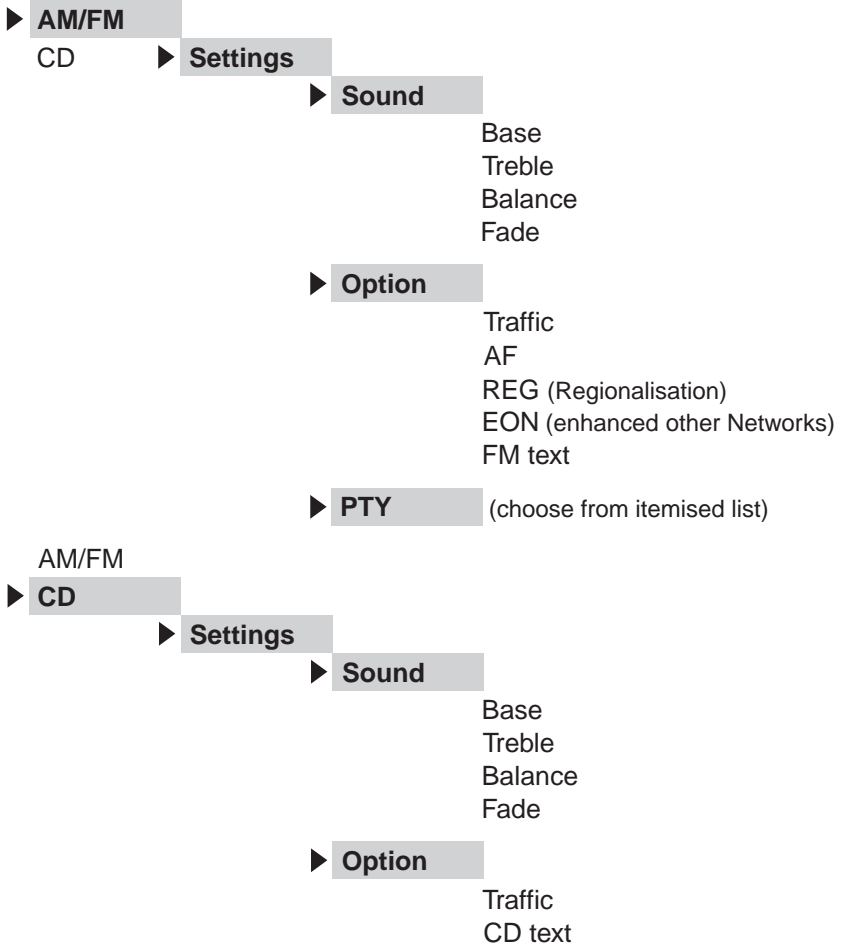

E91336

Audio unit operation

ON/OFF CONTROL

To operate the audio system the ignition must be on (press the START/STOP button).

For the audio system to remain active when the engine is stopped, press the START/STOP button again without pressing the brake pedal.

The audio system can be turned on in two ways:



JAG1572

Press the on/off control on the console, or;

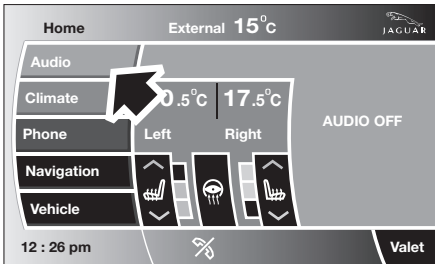

JAG1453

Select **Audio** on the touch-screen Home menu.

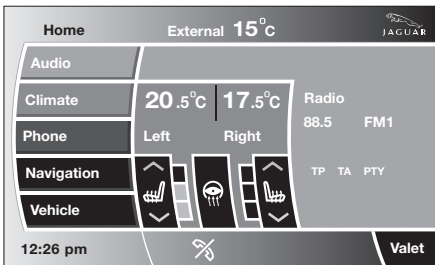

JAG1454

The touch-screen displays the current audio settings. The information displayed will depend on the mode selected (e.g. AM/FM radio).

AUDIO CONTROL

Depending on the specification of the audio system fitted to your vehicle, there are a number of audio control settings available from the **Audio** or **Settings** displays.

Audio - seek tuning

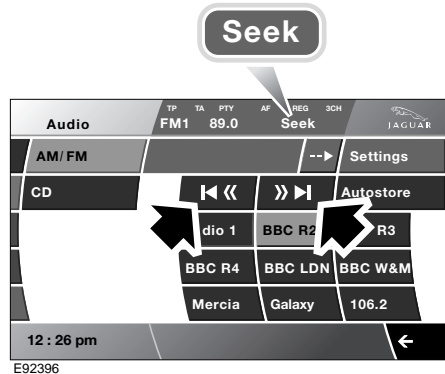

E92396

The **seek down** or **seek up** buttons on the audio console and the touch-screen, carry out the same function.

Short press: In AM or FM mode, touching and releasing the **seek down** (left-hand) or **seek up** (right-hand) buttons will activate the radio tuning through the frequency range, up or down, to the next available station.

The touch-screen will display **Seek** on the upper display until a station has been found, and will then display the station name, where available.

Audio unit operation

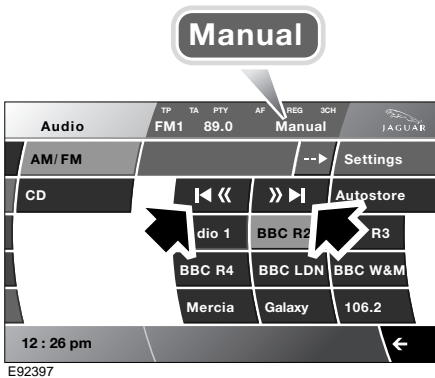

Long press: In AM or FM mode, for as long as the button is being touched, the frequencies will be scanned either up or down.

The touch-screen will display **Manual** on the upper display for a short time. While this is displayed, a short touch of the buttons will also allow the frequencies to be scanned.

Settings - sound

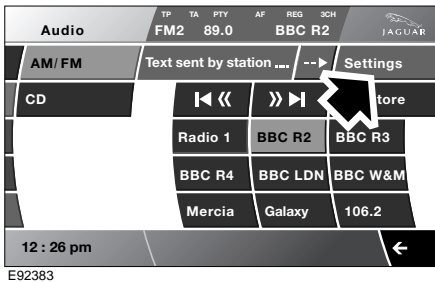

Select **Settings** from the audio main menu to view **Sound** settings.

Bass and treble

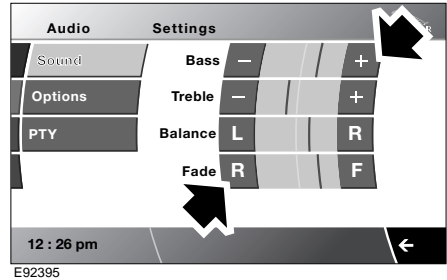

Bass and treble levels are increased or decreased by touching the (+) or (-) buttons.

Balance and fade

Balance - left to right.

Fade - rear to front.

These levels are optimised for a selected seating position by touching the **L** or **R**, **R** or **F** buttons.

Settings - options

Select **Options** from the **Settings** menu, to display the various audio system settings:

- **Traffic:** See **TRAFFIC INFORMATION CONTROL** (page 252).
- **AF** (Alternative Frequencies): See **ALTERNATIVE FREQUENCIES** (page 257).
- **REG:** See **REGIONAL MODE (REG)** (page 256).
- **EON:** See **ENHANCED OTHER NETWORK (RDS-EON)** (page 256).

Audio unit operation

FM text

FM text displays any text message sent out by the current station.

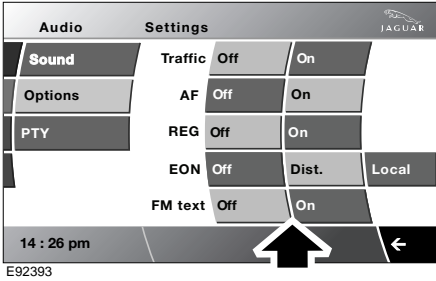

To set the display to show or hide FM text; from the Home menu, select **Settings - Options - FM text (On or Off)**, as applicable.

Text sent by station

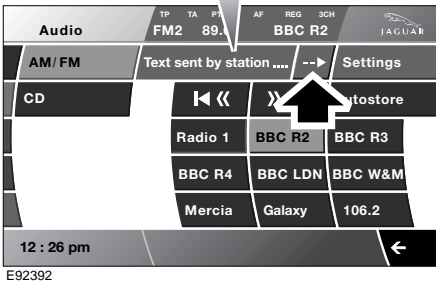

Select the arrow icon to display a pop-up screen showing the complete text message.

The pop-up will time out after approximately 12 seconds, or can be cancelled by touching anywhere within the pop-up.

Automatic Volume Control (AVC)

This maintains radio volume at a level sufficient to overcome road noise as vehicle speed increases or decreases.

To activate the AVC:

- From the **Home** menu, select **Vehicle**.
- Select **Syst. settings**.
- Select **Vol. presets**.

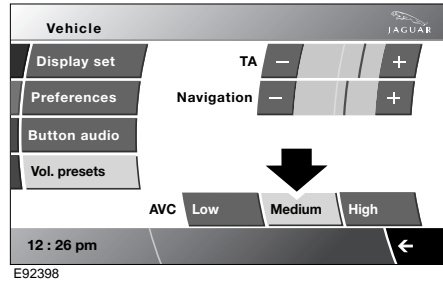

- Select either **Low**, **Medium** or **High** for the **AVC**.

Audio unit operation

JAGUAR PREMIUM SURROUND SOUND

This audio system has the facility of Digital Signal Processing (DSP) which optimises the sound for specific seating positions.

It also allows the user to select stereo, 3-channel stereo or Dolby Pro Logic II Surround Sound™. It is recommended that Dolby Pro Logic II Surround Sound is used in CD mode and strong FM transmissions.

Note: Convertible only: The sound will automatically change for when the convertible top is up or down.

Settings

Note: When some settings are altered, the sound will briefly fade while the settings are changing and will return to normal when the change has been completed.

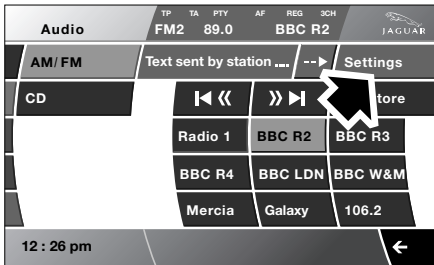

E92383

Select **Settings** to view the available premium audio settings.

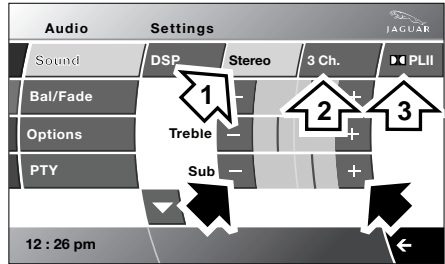

E92400

1. Stereo.
2. 3 Ch.
3. Dolby Pro Logic II Surround Sound.

These levels are altered by touching the (+) or (-) buttons.

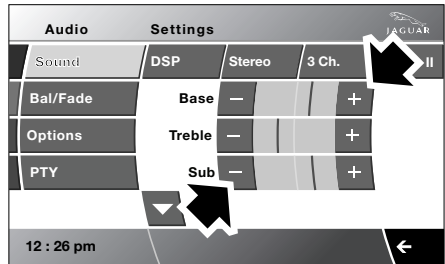

E92399

Bass, Treble and Subwoofer levels are increased or decreased, by touching the (+) or (-) buttons.

Audio unit operation

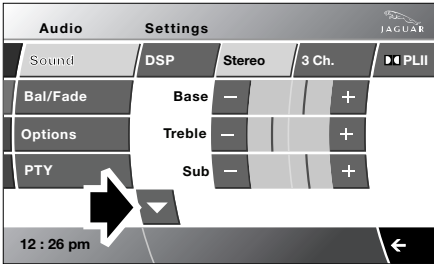

E92401

To select further settings, use the scroll down button to access the next screen display.

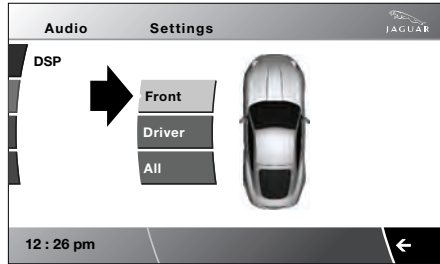

E92404

Select the required configuration (**Front**, **Driver** or **All**).

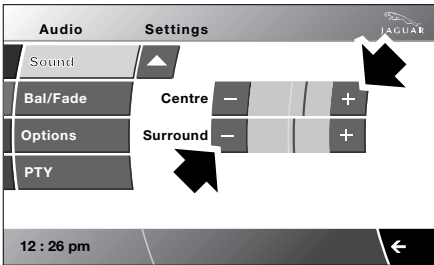

E92402

Adjust the levels by touching the (+) or (-) buttons.

Note: The number of available settings will depend on whether **Stereo**, **3Ch** or **Dolby Pro Logic II Surround Sound** is selected.

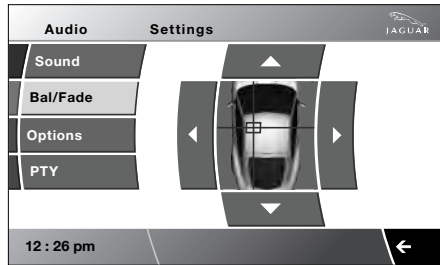

E92405

Bal/Fade: From the audio menu, select **Bal/Fade**. Touch the arrow buttons to optimise the Balance (left to right) and Fade (front to rear) settings.

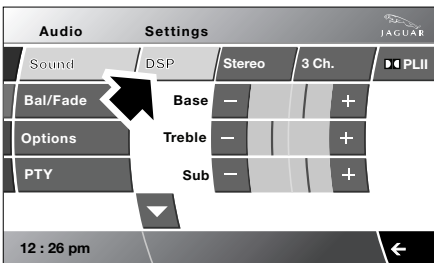

E92403

DSP (Digital Signal Processing): To optimise the sound for specific seating positions select **DSP**.

Audio unit operation

WAVEBAND BUTTON

AM/FM band switching

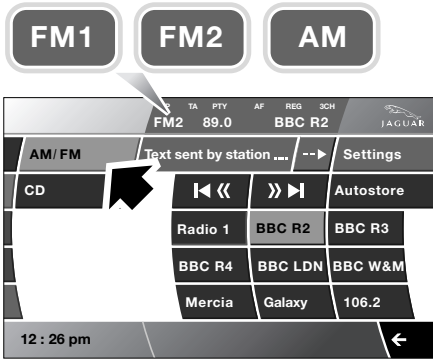

E92329

Touching and releasing the **AM/FM** button, will cycle the radio through FM1, FM2 and AM (a combination of Medium and Long wavebands). Band selection will be shown in the display panel. When a CD is being played, pressing the band switch will select radio operation.

AUTOSTORE CONTROL

Autostore

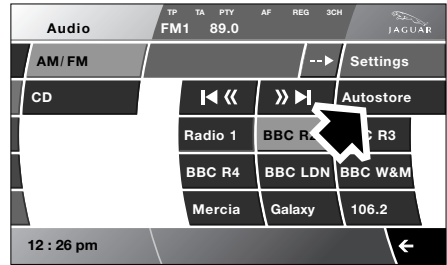

E92337

The autostore memory function, programmes up to nine strong stations on the selected waveband. These stations are stored on presets 1 to 9.

To activate this function, touch and hold the **Autostore** button for at least two seconds.

The radio will be briefly muted while it searches the selected waveband (AM, FM) for the nine strongest stations.

When programming is completed the radio will default to preset number 1, and audio volume will be restored.

If stations cannot be located for all the preset positions, those that are found will be allocated positions commencing with number 1, leaving the remainder not programmed. The display will show ---- and be greyed out, if an attempt is made to select unprogrammed presets.

When programmes have been set: Touch and release **Autostore** to allow the user to switch between the automatically stored and manually stored preset stations.

Audio unit operation

STATION PRESET BUTTONS

Preset stations (1 - 9)

On each waveband (AM, FM1, FM2), nine stations can be memorised using the touch-screen keypad.

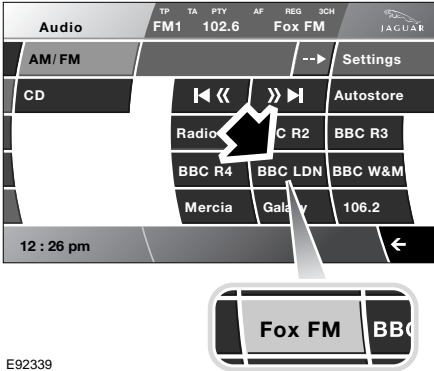

E92339

After tuning to a station, touch and hold (2 seconds) the selected button until the station has been stored. A station can be recalled from the preset memory by touching and releasing the button.

A long press of the steering wheel preset selector button will cycle through the preset stations. See **AUDIO UNIT OVERVIEW** (page 242).

TRAFFIC INFORMATION CONTROL

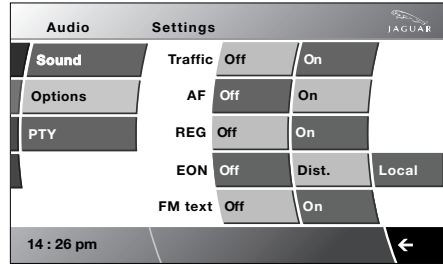

E92340

Traffic Announcements (TA) can be switched **On** or **Off**.

When switched on, **TA** appears in the top of the display screen. The radio then checks that Traffic Programme (TP) is available (indicated by **TP** in the top of the main audio display screen). If **TP** is not available on the current station, the display will not show **TP**.

With **TA** activated, traffic announcements will interrupt radio or CD play. If set at a minimum, the volume will increase for the announcement, returning to normal setting afterwards. When receiving, the display will show a traffic announcement pop-up.

Audio unit operation

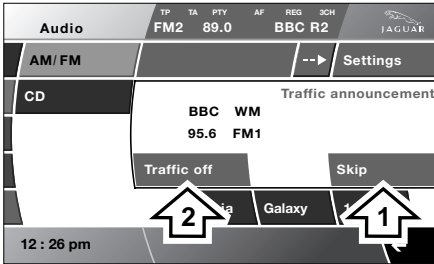

E92341

TA and priority (PTY) skip: Interruptions for Traffic Announcements, **NEWS** or other selected priority **PTY**, can be skipped, by selecting the **Skip** button (1). This will cancel the pop-up and the announcement. The radio will return to the previously selected audio source.

Touching anywhere within the pop-up will cancel it, but the announcement will continue. Select **Traffic off** (2), to turn off the traffic announcement facility entirely. The **TA** indicator will clear from the display.

Note: *Skip will not cancel activation of TA or priority PTY which remain ready for the next announcement.*

Note: *TA, PTY and priority PTY features, are reliant upon the broadcast information from radio stations and may be much better in some areas than in others.*

Preset TA volume

When the radio is set to minimum volume and a traffic announcement occurs, the volume is raised to a preset level.

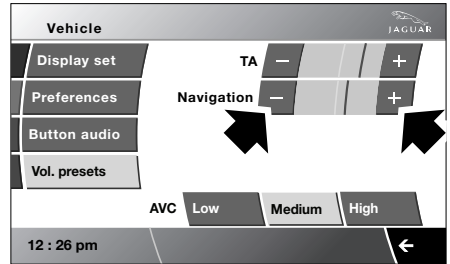

E92342

This level can be adjusted by setting the volume level on the **Vehicles - Syst. settings - Vol. presets** screen or, by turning the volume rotary control knob during the traffic announcement.

Audio unit menus

RADIO DATA SYSTEM (RDS)

Your radio is equipped with RDS, which enables the audio unit to receive additional information with normal radio signals.

When tuned to certain stations on the FM waveband the radio decodes signals transmitted to provide the following functions (dependent upon the service available from the broadcasters).

Note: *Not all FM radio stations broadcast RDS. If a non-RDS station is received, RDS features will not be available.*

- RDS station name display: When RDS is selected the station name is displayed.
- Automatic re-tuning to follow network stations: RDS provides fully automatic Alternative Frequency (**AF**) radio tuning for network stations. It tunes to a signal not a frequency. RDS will locate the strongest signal available for a given station.
- RDS will automatically switch frequencies (AF Switching) as necessary. This function can be toggled off. See **STATION PRESET BUTTONS** (page 252).
- RDS Priority programme type auto re-tuning (where broadcast): Similar to Traffic Announcement this can be selected to interrupt and switch to the selected programme type (e.g. **News**), for its duration or can be used to search for specific **PTY** stations.
- RDS provides an **EON** (Enhanced Other Networks) facility, which offers the ability for local stations to break into a national station's broadcast for the duration of a traffic announcement. When listening to a national station, **EON** will tell the radio about any traffic bulletins being broadcasted by stations in the local area. The radio will switch to the local radio station for the travel bulletin, then back to national station when the bulletin has finished. This feature is not usually implemented on commercial radio stations.
- Local radio station traffic information (where broadcast): RDS provides travel information relevant to the vehicle location. On learning of a traffic problem, the authorities inform the nearest local radio station. The traffic announcement (**TA**) is then broadcast by transmitters in the relevant area. Provided **TA** has been selected, traffic announcements will interrupt radio, or CD play, on all equipment with the RDS feature. If the volume control is set at minimum it will automatically increase to an audible level for the duration of the traffic news flash. When the traffic announcement has been completed, the system reverts to the driver's original listening choice and volume setting.

If the RDS function does not respond correctly, see the trouble-shooting guide on the next page.

Audio unit menus

RDS trouble-shooting guide

Incorrect response from RDS	Reason and rectification
Radio does not display programme name.	RDS name is not available from the broadcast.
Station name is lost and displays frequency only.	Radio has lost reception of the RDS data due to vehicle moving out of transmitter range, loss of signal in a tunnel, under a garage forecourt canopy, or similar screening. If the latter is the case, when the vehicle is clear of the screening, the station name will return after a short delay.
Radio sound goes off and the display shows PI SEEK .	The RDS radio station selected is unable to confirm that the frequency tuned to has the correct RDS data - Programme Identification (PI). It will then seek for a frequency that has the correct data.
Radio sound goes off and the display shows TP SEARCH (If Traffic Announcements (TA) has been selected).	The RDS radio station selected is unable to confirm that the frequency tuned to has the correct RDS data - Traffic Programme (TP). It will then seek for a frequency that has the correct data to support the selected TA feature.
REG: If a preset button is pressed and a different local station is tuned to.	When REG is off, if the station has links to other stations with similar PI codes (identity codes) it will tune to it; turn REG On to keep the station tuned to the same PI code and not a similar one.

Audio unit menus

REGIONAL MODE (REG)

As you drive into different radio reception areas, RDS automatically retunes the radio to the strongest signal. Regional mode is an RDS feature which stops the system from tuning to another local radio station with a stronger signal. With this feature enabled, your selected local radio station will remain tuned.

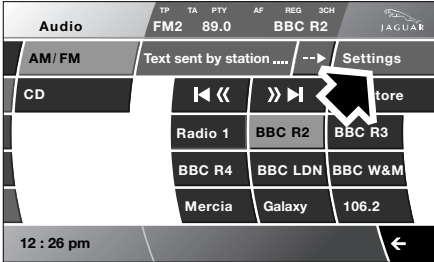

E92383

Select **Settings** from the audio main menu, then select **Options**.

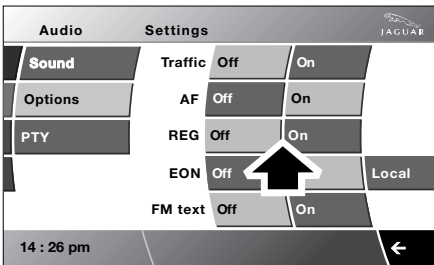

E92385

Select **REG On** or **Off**.

Off - Seeks for frequencies of local regional stations within the local area.

On - The frequency will remain on the set station frequency and will not seek for further local station frequencies.

ENHANCED OTHER NETWORK (RDS-EON)

The Enhanced Other Network (EON) feature will tune to any radio station of the same station network as the one that you are listening to, once the signal gets weak.

Either local or distant networks can be selected by the EON feature.

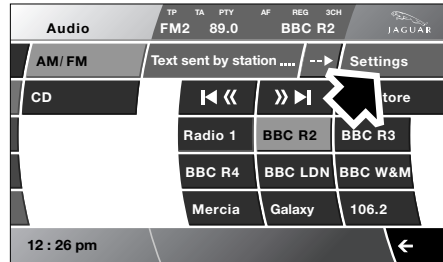

E92383

Select **Settings** from the audio main menu, then select **Options**.

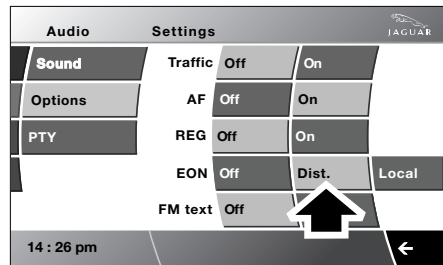

E92389

Select **EON Off**, **Dist.** or **Local**, as required.

Audio unit menus

ALTERNATIVE FREQUENCIES

Some radio stations broadcast on different frequencies in different parts of the country. If the selected station signal weakens, the radio will automatically re-tune to a stronger alternative frequency, if one is available. This feature is particularly useful on long journeys where the vehicle travels through different transmitter areas serving the same radio station.

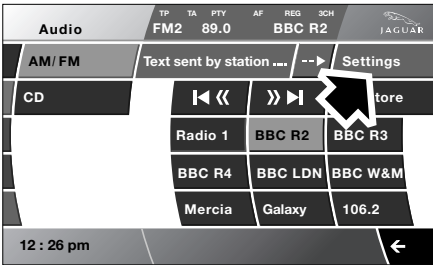

E92383

Select **Settings** from the audio main menu, then select **Options**.

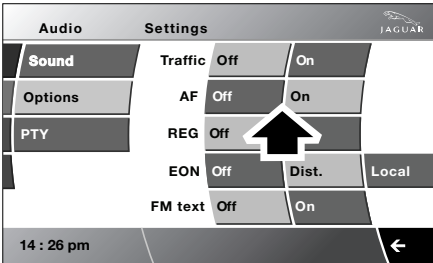

E92384

Select **AF On** or **Off**.

With AF on, if a better alternative frequency cannot be found, the radio returns to the original frequency.

Digital audio broadcasting

GENERAL INFORMATION

Digital radio reception

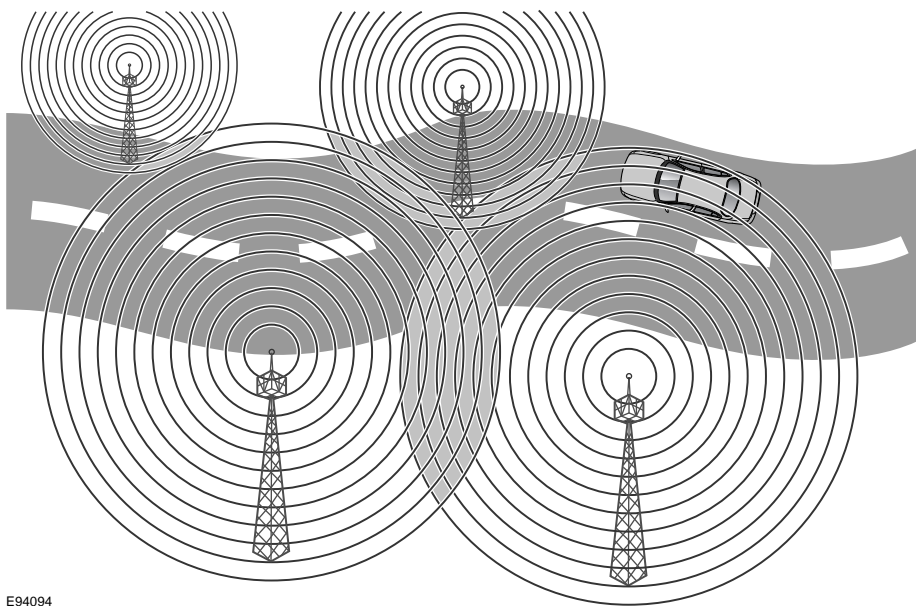

E94094

DAB radio is very different from normal AM/FM radio in both operation and sound quality. The DAB network is designed to provide near CD quality from radio broadcasts. In most locations DAB signals are available without hiss, crackle, pop or interference, and no fading or overlap.

DAB radio can significantly increase the number of radio channels/stations available. The DAB signals are transmitted to most major cities, towns and motorway networks.

Radio signals travel in a straight line so large obstacles, such as tall buildings, can shield the vehicle from the signal, causing temporary loss of reception (known as dead spots).

Digital radio is transmitted from regional transmitters. Some local channels are not available outside the range of their transmitters. If you want to listen to local channels as you move around the country, use the auto-tune function (AUTO) to build new channel lists. For more information on the auto-tune function. See **CHANNEL AUTOMATIC TUNING** (page 262).

Note: *If any auxiliary electrical equipment is connected to the vehicle, then this may reduce the DAB radio sound quality.*

Digital audio broadcasting

Ensembles

Unlike AM/FM radio, DAB transmits several channels/stations on a single frequency. A group of channels is known as an ensemble. Ensembles may consist of six or more channels (national or local). Some may have sub-channels offering several listening options.

When scrolling through the channels the sub-channels will appear in order, and can be selected in the same way as the channels. If reception is lost when the vehicle is in motion select **AUTO** to build a new list of ensembles.

The table below provides an example of the ensembles, channels and sub-channels available in one location.

Ensemble	Channel/station	Sub-channel 1	Sub-channel 2
First ensemble	Channel/station 1		
	Channel/station 2	Sub-channel	
	Channel/station 3		
	Channel/station 4		
	Channel/station 5		
	Channel/station 6	Sub-channel	Sub-channel
	Channel/station 7		
	Channel/station 8		
	Channel/station 9		
Second ensemble	Channel/station 1		
	Channel/station 2		
	Channel/station 3		
	Channel/station 4		
	Channel/station 5		
	Channel/station 6		
Third ensemble	Channel/station 1		
	Channel/station 2		
	Channel/station 3		
	Channel/station 4		

Digital audio broadcasting

AUDIO CONTROLS



JAG1391

1. Touch-screen. See **TOUCH-SCREEN** (page 101).

2. On/off and volume control.

3. **SOURCE** button.

Press repeatedly to select the next available audio source: FM1, FM2, AM, DAB1, DAB2, DAB3, CD, iPod, USB, Auxiliary.

4. Seek up.

- Short press to find the next channel.
- Long press (two seconds) to find next available ensemble.

5. Seek down.

- Short press to find previous channel.
- Long press (two seconds) to find previous available ensemble.

Steering wheel controls

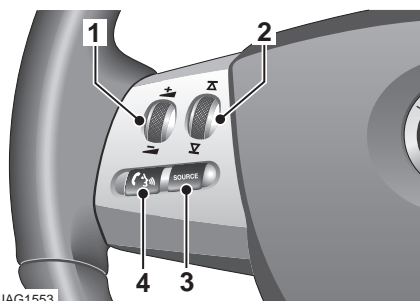

JAG1553

1. Rotate up or down to increase or decrease the audio volume.

2. Rotate and release to scroll through channels. Rotate and hold for two seconds to select next available digital ensemble.

3. Press the **SOURCE** button repeatedly to scroll through the available audio sources FM1, FM2, AM, DAB1, DAB2, DAB3, CD, iPod, USB and Auxiliary input.

4. Press to mute the audio unit. This button is also used to start, answer or end calls in phone mode and to start a Voice session.

Digital audio broadcasting

DISPLAY OPTIONS

Touch-screen information panel

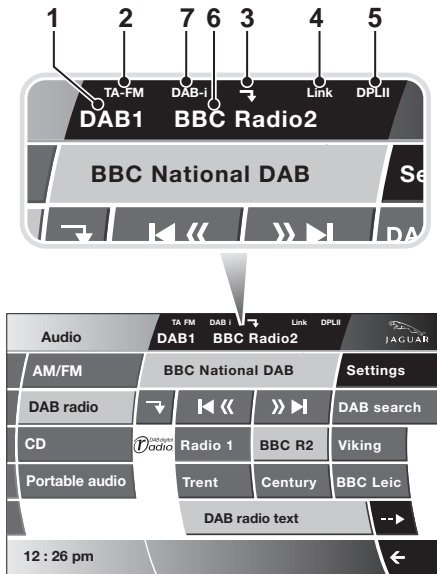

JAG1392

1. DAB band indicator.
2. **TA-FM** is displayed if the FM traffic option is enabled. See **SETTINGS** (page 266).
3. The arrow icon indicates that subchannels are available under the current channel. **SubCh** is displayed if a subchannel is tuned to.
4. **Link** is displayed if the Link DAB option is enabled. See **SETTINGS** (page 266).
5. Dolby Prologic II surround sound indicator.
6. Channel name.
7. **DAB-i** indicates that DAB Announcements are enabled.

Note: The display can also show **PTY** or **Ensemble** information if you have selected one of these options under **DAB text** on the Settings menu. See **SETTINGS** (page 266).

DAB radio text

Many digital channels transmit additional text (DLS, Dynamic Label Segment) to accompany a broadcast. For safety reasons, this text does not scroll across the screen.

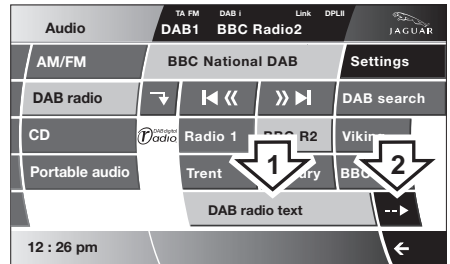

JAG1393

The first 16 characters of text are displayed (1). If you want to read the full text, you must select the additional text button (2).



JAG1394

The **DAB radio text** pop-up screen displays all 128 characters of text. This text may change periodically, if the broadcaster chooses to do so.

To remove the pop-up screen, briefly touch it.

Digital audio broadcasting

CHANNEL AUTOMATIC TUNING

Note: When you first use the DAB radio, you will be unable to listen to any digital broadcasts until you have completed the auto-tune process.

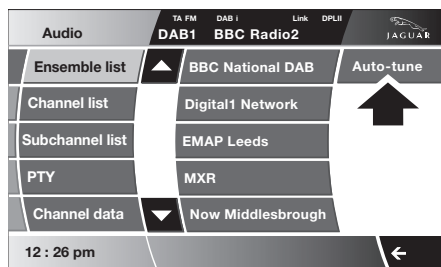
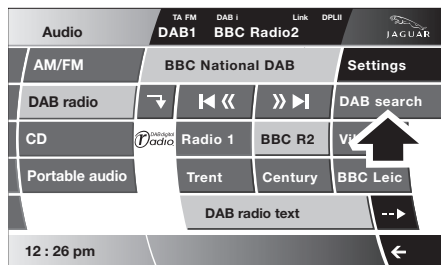

JAG1395

In DAB mode, select **DAB search**, then select **Auto-tune** to start automatic tuning and build a list of all the digital ensembles and channels that are available in your region.

While automatic tuning is running, the message **Auto-tuning** will be displayed on the touch-screen, along with a percentage complete. When tuning is complete, the first channel found will start playing.

Note: The auto-tune process can take longer than one minute to complete.

To update the list of local channels when you move to a different region, select **Auto-tune** again. You can also add local channels as presets to minimise the need for auto-tuning as you move location.

CHANNEL OPTIONS

To receive digital broadcasts, short press the **SOURCE** button repeatedly to toggle between the available sources, or briefly touch the **DAB Radio** button on the touch-screen. See **AUDIO CONTROLS** (page 260).

Choose **DAB1**, **DAB2** or **DAB3** to receive digital radio broadcasts. The three DAB sources enable you to preset up to 18 different channels. See **PRESET BUTTONS** (page 265).

The channel that was last played on your chosen digital source will be selected for playback automatically.

Note: If this is the first time you have used DAB radio, you must first build a list of available channels using the auto-tune function.

Digital radio channels are organised into groups called ensembles. Some channels may sometimes provide one or more subchannels.

Digital audio broadcasting

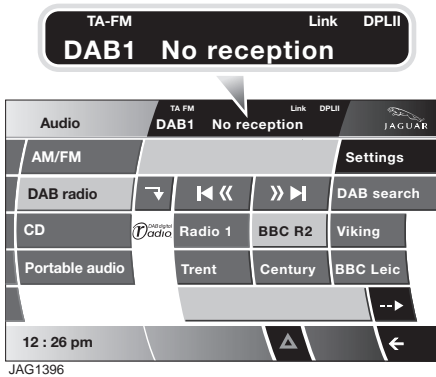

JAG1396

If the digital radio signal is lost or the system takes time to tune in to a channel, then the display screen will show the message **No reception**.

The problem may be caused by a temporary problem, such as buildings or trees blocking the signal, or it might be a problem with the broadcast service operator. Try tuning to an alternative channel and return later to see if the problem has been resolved. If you are unable to tune to any other channels, switch off the audio unit and then try again.

Finding a channel

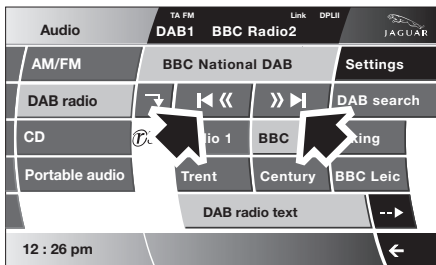

JAG1397

Briefly touch one of the channel seek buttons to select the next available digital channel. The seek up button selects the next channel, the seek down button selects the previous channel.

Note: If the next or previous channel is in a different ensemble, then there will be a pause before the channel is located. The message **Searching...** is displayed on the screen.

On the touch-screen, if channels have been preset, select one of the six preset buttons to start playing that channel. If no channel has been preset, the button will display ---.

Finding a subchannel

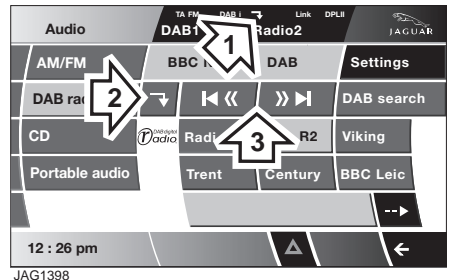

JAG1398

If subchannels are available under the current channel, the subchannel arrow icon (1) is displayed at the top of the touch-screen and the Subchannel button is enabled.

To access the subchannels, select the downward-pointing arrow (2). Select the seek buttons (3) to find the next/previous subchannel.

To return to the channel tier, select the upward-pointing arrow.

Note: When you select and play a subchannel, the subchannel icon is replaced by **SubCh**.

Note: You cannot store a subchannel as a preset.

Note: If you select the preset button for the channel containing the subchannel you are currently playing, you will be returned to the channel.

Digital audio broadcasting

Finding an ensemble

Touch and hold (two seconds) the seek buttons to find the next or previous ensemble. See **AUDIO CONTROLS** (page 260).

After a few seconds pause, the first channel in the ensemble found will start playing.

DAB search

The DAB search menu enables you to view lists of available ensembles, channels and subchannels. You can also perform searches based on programme type (PTY).

Select **DAB search** to display the DAB search menu.

Auto-tune

Select **Auto-tune** to build a list of available ensembles and channels for your current location. See **CHANNEL AUTOMATIC TUNING** (page 262).

Ensemble list

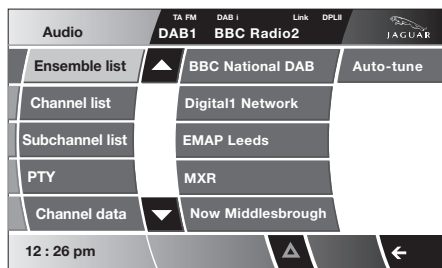

JAG1399

Select **Ensemble list** to display a list of all available ensembles. Select an ensemble name in the list to display a list of channels in that ensemble. Select a channel name to tune that channel.

Channel list

Select **Channel list** to display a complete list of all channels in all available ensembles. Select a channel name to tune that channel.

Subchannel list

Select **Subchannel list** to display a list of any subchannels available for the currently tuned channel. If no subchannels are currently available, then the Subchannel list option is disabled. If the maximum five subchannels are available, then use the arrows to scroll through the list.

PTY

Channels are categorised by the broadcaster as belonging to a programme type (PTY) category. You can display a list of channels organised according to their PTY category.

Select **PTY** to display a list of PTY categories that contain channels. Select a PTY category to display a list of channels in that category. Select a channel name to play that channel.

Briefly touch one of the seek buttons repeatedly during the first ten seconds of broadcast, to cycle through all channels contained in the PTY category that you chose. Stop touching the seek button when you have found a channel you want.

Channel data

Select **Channel data** to display technical data relating to the currently-tuned channel. The data listed is as follows: Channel name, Ensemble name, Bit rate (kbits/s) and Audio level.

Digital audio broadcasting

PRESET BUTTONS

Storing channels as presets

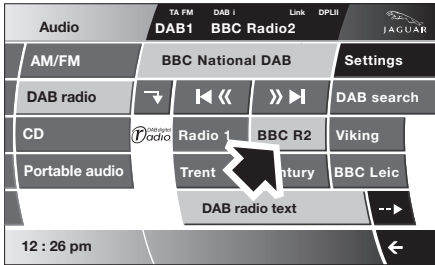

Store up to eighteen digital channels (six each on **DAB1**, **DAB2** and **DAB3**) using the numbered preset keys. Follow the procedure below to store channels as presets.

1. Search for and start playing the channel you want to preset.
2. Touch and hold (two seconds) the preset button on which you want to store the current channel. Audio output is muted for a further two seconds while the channel is stored and a confirmation message is displayed.
3. Repeat steps 1 and 2 for each channel that you want to store as a preset.

Note: You cannot store a subchannel as a preset. If you try to store a subchannel, you will store the channel to which the subchannel belongs.

Recalling a preset channel

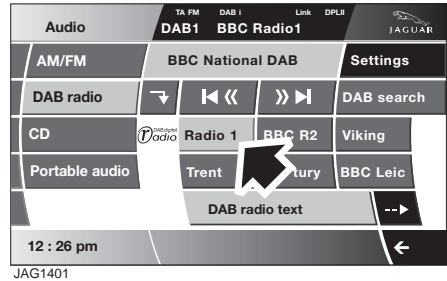

Make sure that you have selected the appropriate digital source (**DAB1**, **DAB2** or **DAB3**) and then briefly touch the preset button you require. The channel you have selected will start to play automatically.

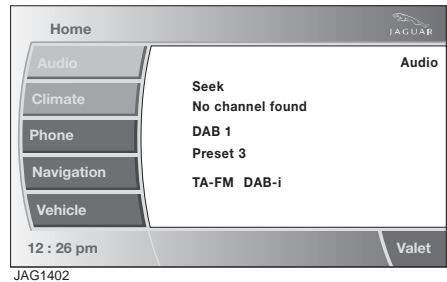

Note: If you try to recall a channel that has previously been stored as a preset, but is now unavailable or invalid, the message **No channel found** is displayed. You must choose another channel.

Digital audio broadcasting

SETTINGS

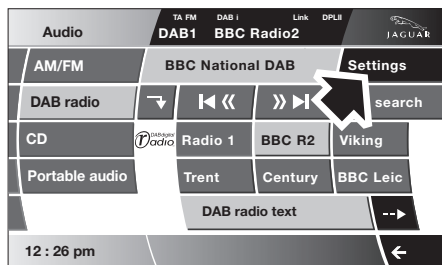

JAG1403

In DAB mode, select **Settings**.

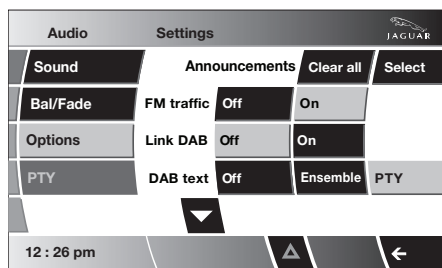

JAG1404

Select **Options**.

Note: If **Settings** is selected once, but no action is taken for a further ten seconds, the system will exit the menu automatically.

Announcements

You can select up to four types of announcement from a list of eleven, for example, **News**, **Area/Weather**, **Traffic** and **Alarm**.

When a DAB announcement is broadcast, it will interrupt normal play for the duration of the announcement.

Note: The **Alarm** announcement type, broadcasts information concerning crises of national or international importance.

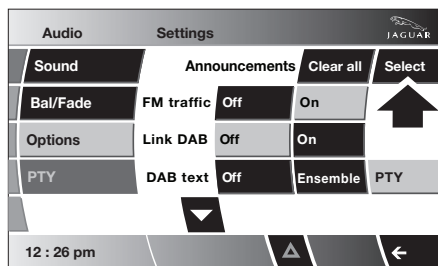

JAG1405

To display the full list of announcement types, touch **Select**.

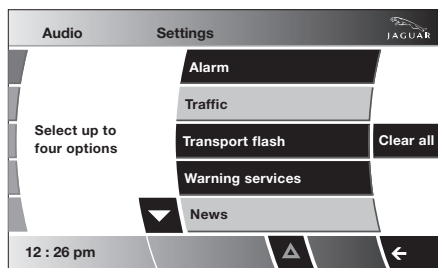

JAG1406

Select an announcement type to enable it, select it again to disable it. If you want to clear all enabled types, select **Clear all**. To scroll through the list, select the arrow buttons.

Note: If you have already selected four announcement types, you will be unable to select further types.

Digital audio broadcasting

FM traffic

The **FM traffic** option detects the presence of local traffic announcements on FM stations. As soon as an announcement is received, radio reception or CD play will be interrupted. At the end of the announcement, radio or CD play will resume.

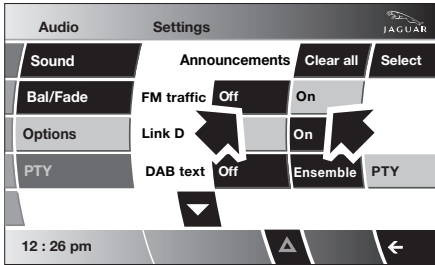

Select **On** or **Off** to enable or disable the FM traffic option.

Note: *The audio unit switches to an FM broadcast for the duration of the announcement, so there may be a temporary loss of sound quality.*

Link DAB

Regional ensembles containing a list of local digital channels are broadcast by a variety of regional providers. For example, the Leicester and Coventry regions in the UK are currently supplied by Now Digital, whereas Birmingham is supplied by CE Digital.

A channel (for example, Chill) in two different regional ensembles will share an identification if broadcast by the same provider (for example, Chill Coventry and Chill Leicester). If channels are being broadcast by different suppliers, then they will not share the same identification (for example, Chill Coventry and Chill Birmingham).

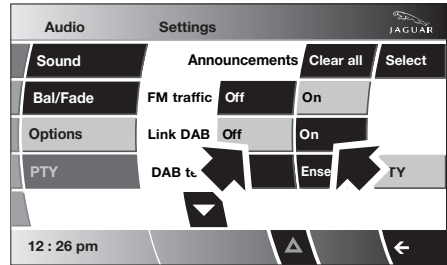

If you move from one region to another and **Link DAB** is enabled, the DAB radio will attempt to retune to a channel with the same identification in a different ensemble.

If the signal strength for a local channel falls below an acceptable level, the audio unit will automatically search other available ensembles for another channel with the same identification.

If an alternative channel is found in another ensemble that is also in your current channel list, then the new channel is tuned automatically after a few seconds. If a channel is not found after a few seconds, then **No reception** is displayed on the screen.

The word **Link** is displayed at the top of the touchscreen to indicate that Link DAB is enabled.

Digital audio broadcasting

DAB text

The DAB text option controls the type of information that is displayed on the screen when a channel or subchannel is playing.

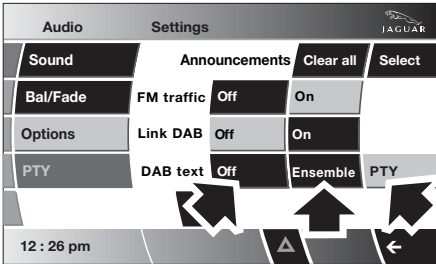

JAG1409

- Select **Ensemble** to display the name of the ensemble to which the current channel belongs.
- Select **PTY** to display the name of the programme type to which the current channel belongs.
- Select **Off** to display only the channel name.

DAB country

If you move the vehicle to a different country, you can change DAB Country options to make sure that you receive the best possible reception and sound quality.

Note: If you have already selected a DAB format, then the DAB country option is disabled.

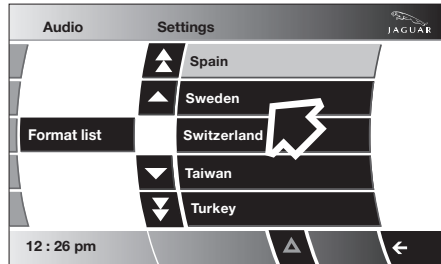
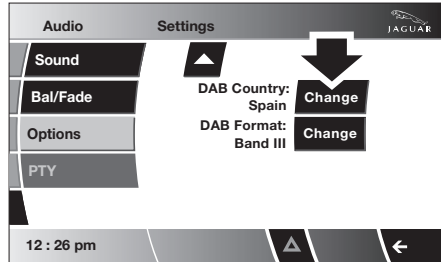
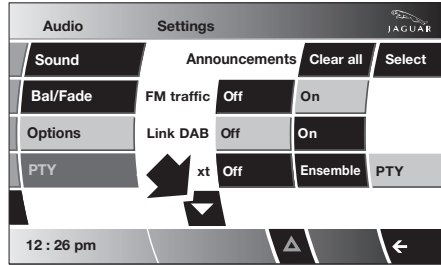

JAG1410

Select **Change** to display a list of countries where DAB services are available. Select the country name to enable it.

Note: When you change the DAB country, the audio unit will automatically start auto-tuning. If you **Cancel** the auto-tune, the country setting will remain changed but you may not have access to all available ensembles for that country. See **CHANNEL AUTOMATIC TUNING** (page 262).

Note: This option is disabled when the vehicle is moving

Digital audio broadcasting

DAB format

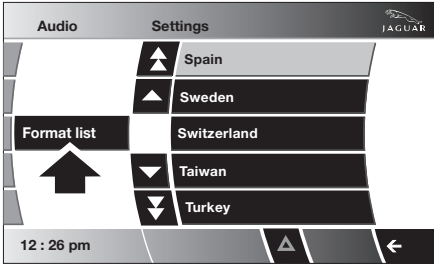

Note: When you change the DAB format, the audio unit will automatically start auto-tuning. If you **Cancel** the auto-tune, the format setting will stay changed but you may not have access to all available ensembles for that format. See **CHANNEL AUTOMATIC TUNING** (page 262).

Note: This option is disabled when the vehicle is moving

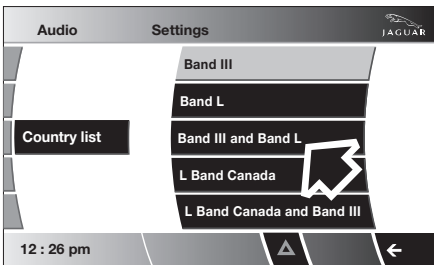

JAG1411

Different regions or countries may use different digital bands to broadcast DAB channels. If you know the band(s) required, then you can choose from the **Band selection** list.

Select **Change** to display a list of formats. The available bands are:

- L Band
- Band III
- L Band & Band III
- L Band Canada
- L Band Can & Band III

Compact disc player

COMPACT DISC COMPATABILITY

CAUTIONS

- ❗ Irregular shaped CDs and CDs with a scratch protection film should not be used.
 - ❗ CDs with labels (or stickers) attached should not be used. Labels may become warped and prevent the CD from being ejected, causing damage to the CD player. Such damage is not covered by the warranty agreement.
 - ❗ The CD unit will play compact discs that conform to the international Red Book standard audio specification. Copy protected CDs from some manufacturers do not conform to this standard and playback cannot be guaranteed.
 - ❗ Due to technical incompatibility, recordable (CD-R) discs and re-writable (CD-RW) discs may not function correctly.
 - ❗ Dual format, dual-sided discs (DVD Plus, CD-DVD format), now being adopted by the music industry, are thicker than normal CDs and consequently playback cannot be guaranteed in Jaguar audio units, and jamming could occur. Warranty claims, where this type of disc is found to be inside an audio unit returned for repair, will not be accepted.
-

The following CD formats may cause the CD player to malfunction. It is recommended that the following types of CD are not used:

- 8 cm (3.1 in.) discs with or without an adaptor.
- CDs that are not circular.
- CDs with a paper label.
- CDs that are warped, dirty, scratched or have an abnormal edge.
- Dual format, dual-sided discs (DVD Plus, CD-DVD format).
- DVDs.

It is recommended that only high quality 12 cm (4.7 in.) circular discs, that show the Compact Disc Digital Audio logo, are used.

LOADING COMPACT DISCS

CAUTIONS

- ❗ Do not force the disc into the slot.
- ❗ Copyright laws vary in different countries; please check the laws in your country if you want to record from copyright source material.

Note: *Some privately recorded CD-R discs may not have been acceptably formatted to be able to be played on this CD player.*

An in-dash compact disc (CD) player is installed in the audio unit. The CD player will accommodate either one CD (single disc player), or up to six CDs (six disc player), depending on the audio unit fitted to your vehicle.

The CD player will play Compact Disc Digital Audio (CDDA) discs (normal discs), MP3 and WMA files.

Compact disc player

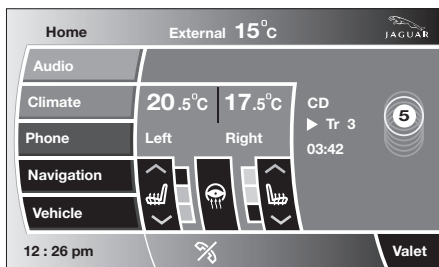

JAG1455

The Home menu will indicate whether a CD is loaded and, where applicable, which CD slot is loaded and ready for playing. If no CDs have been loaded, the touch-screen displays ghosted discs.

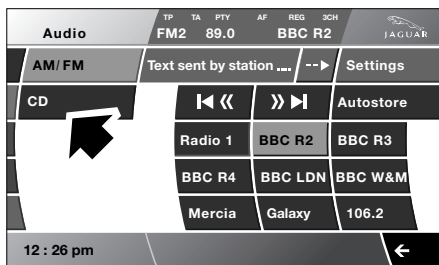

E92464

To access the CD player touch-screen:

- From the main **Home** touch-screen menu, select **Audio**.
- Select **CD**.

Alternatively, repeatedly press the SOURCE button on the audio unit or the steering wheel, to scroll through all audio sources to display the CD controls.

Loading a CD (player empty)

Load a CD into the loading slot. A CD loading message is displayed on the touch-screen.

Loading one CD (six disc player part-loaded)

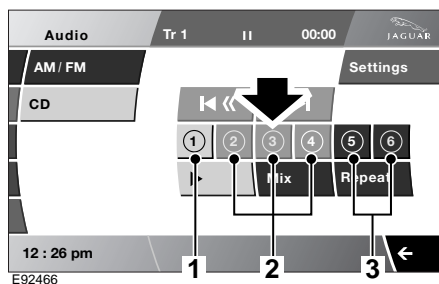

E92466

From the CD player touch-screen, select an empty slot (2). A message indicates to insert the CD into the loading slot. Load the CD.

Note: 1 indicates the CD currently playing. 3 indicates the slots which are already loaded.

Loading more than one CD (six disc player)

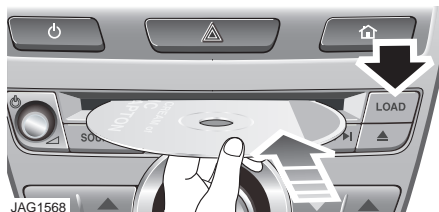

JAG1568

Press the **LOAD** button and insert each CD into the CD slot, as requested by the displayed message. A pop-up message on the screen will indicate which slot is being selected, until the unit is fully loaded.

When the CD player has been loaded, CD operation is via the touch-screen CD menu.

Compact disc player

EJECTING COMPACT DISCS

To unload the CD player



Press the eject button. A short press will eject a single CD, a long press will eject each loaded CD in turn (six disc players only).

When a disc is ejected, remove it from the loading slot. If you fail to remove an ejected disc, it will be drawn back into the player after ten seconds.

If you want to stop ejecting multiple discs, select **Cancel** on the touch-screen.

COMPACT DISC SELECTION (six disc players)

CD touch-screen display

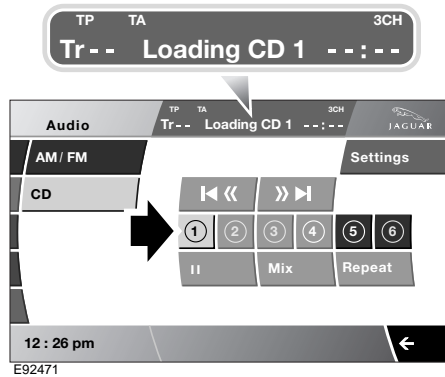

When a CD has been selected (arrowed), the upper display indicates which disc is being loaded and will commence playing when loading has been completed.

TP	The background radio station provides Traffic Programme TP signals and is able to support Traffic Announcement TA.
TA	Traffic announcements are available in the CD mode and will interrupt the playing of the CD. At the end of the announcement the CD will resume playing.
DPLII or 3CH	Surround mode: Dolby Pro Logic II or 3-channel selected.

Compact disc player

TRACK SELECTION

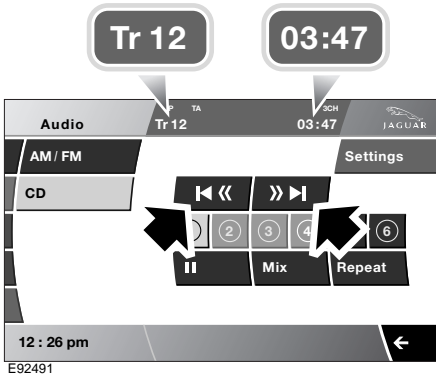

Seek down and seek up buttons (arrowed):

- **Short touch:** Seeks down to previous track or up to next track.
- **Long touch:** Touch and hold the seek down button to play rapidly back through one or more tracks (review). Touch and hold the seek up button, to play rapidly forward through one or more tracks (cue). Normal playback will resume when either button is released.

Tr 12 - Track number display of the track being played.

03:47 - Track elapsed time play.

COMPACT DISC PAUSE

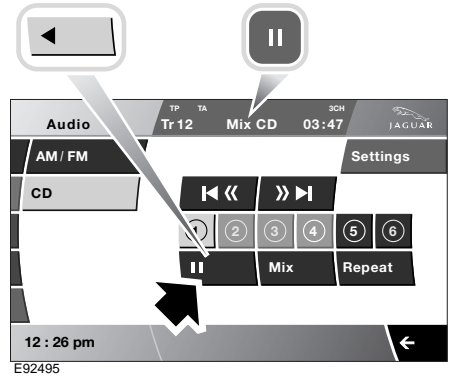

Touch to pause the current track. Touch again to resume playback.

REPEAT COMPACT DISC TRACKS

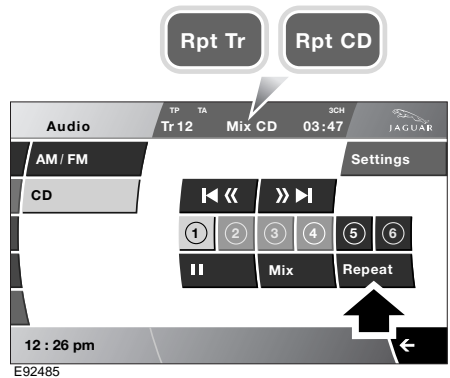

- **Track repeat:** Touch and release the **Repeat** button to repeat the current track continuously (**Rpt Tr** is displayed). Cancel by touching the **Repeat** button again.
- **CD repeat:** Touch and hold the **Repeat** button to repeat the whole CD continuously. Cancel by touching the **Repeat** button again.

Compact disc player

SHUFFLE/RANDOM

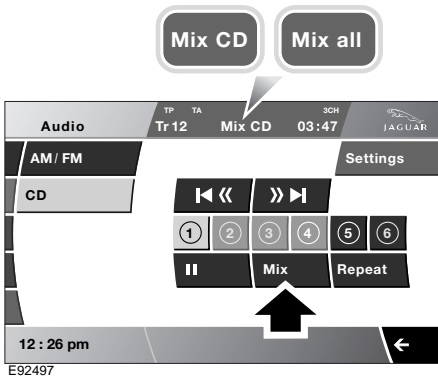

Mix CD: Touch and release the **Mix** button. The track order of play from the current CD, is randomly selected by the CD player. On MP3 CDs, a short touch will mix the tracks from the current folder.

Mix all: Touch and hold the **Mix** button. The order of play is randomly selected from all the loaded CDs (six disc players). On MP3 CDs, a long touch will mix the tracks from all the folders of the current MP3 disc.

Note: If the volume is turned down to zero, CD play is automatically paused. Play is resumed when volume is increased.

COMPACT DISC DISPLAY OPTIONS

Settings

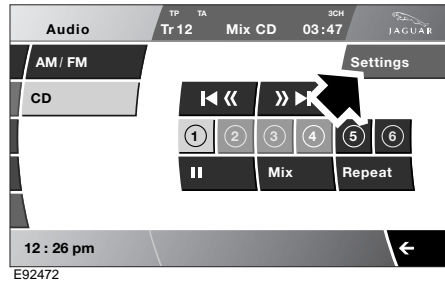

In CD mode, select Settings to display the CD settings menu.

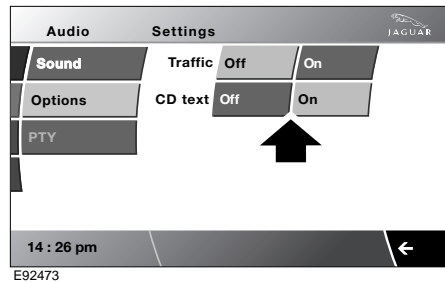

Traffic: Traffic announcements can be switched **On** or **Off**. See **TRAFFIC INFORMATION CONTROL** (page 252).

CD text: CD text can be switched **On** or **Off**. CD text displays track-related information that has been saved onto the CD (not all CDs will provide CD text).

Compact disc player

MP3 FILE PLAYBACK

MP3 discs have the potential to hold more music than a conventional CD, because each track can be compressed to a higher degree during recording.

If you record your own music, each session must be properly closed, but the whole disc does not have to be finalised.

Some pre-recorded and personally recorded discs can contain additional information on the disc, e.g. CD titles, track titles and the artist's name (ID 3 Tags).

Additional touch-screen controls enable you to select folders and tracks and display various items of information about the recordings.

CAUTIONS



Copyright laws vary in different countries; please check the laws in your country if you want to record from copyright source material.

Note: A mixture of CDs and MP3 discs can be loaded into the CD player together (six disc players only).

Note: The audio system will play MP3, WMA, WAV and AAC files.

Note: The CD player is not guaranteed to play every disc available because of variations in the quality of discs.

Playing MP3 discs

When an MP3 disc is first played, the first track in the root folder will play first. If you restart play after switching to another disc or audio source, then play will resume from the point you left it.

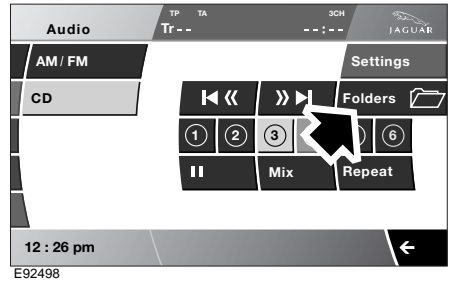

If the MP3 disc has been recorded with the music files contained within folders, additional information is available by selecting **Folders**.

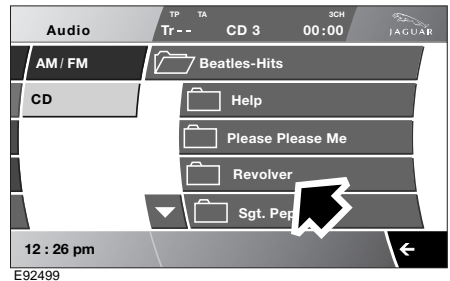

A list of folders and files is displayed on the touch-screen. The titles of any folders and tracks recorded on the CD, will be displayed in alphabetical order, even when the disc has been recorded in a different order.

Compact disc player

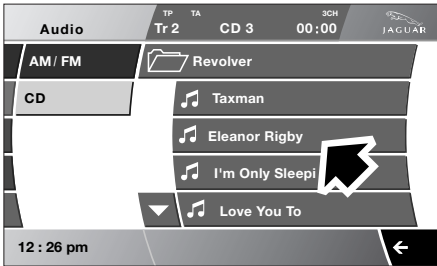

E92500

Select the folder to access the tracks contained within the folder. To help you navigate through multiple folders and files, the display changes when you select folder, sub-folders and tracks.

If more than four folders or files are listed, select the up/down arrow icons, to scroll through the list.

Select a track to start playback.

Note: If you have selected a track using the Folders function, then you will return to the same folder when you next access the folder menu.

MP3 folder structure

A CD-R or CD-RW can have MP3 folders and tracks recorded in many different ways, with many layers of folders and with tracks distributed throughout the folder structure.

Note: Any CD containing a mixture of MP3 and CDDA tracks will be treated as a CD (any MP3 tracks will be ignored).

Note: The CD player may take a long time (one minute or more) to load an MP3 disc, owing to the number of tracks on it. To minimise the loading on the system, a rigid folder structure is recommended.

Portable audio

PORTABLE AUDIO

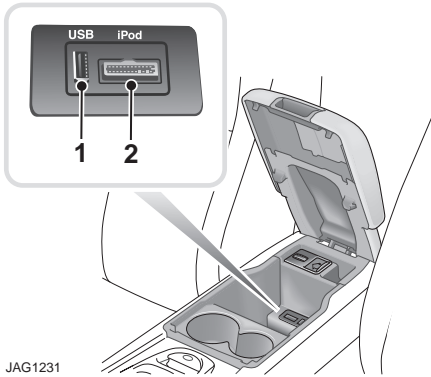

JAG1231

1. USB connector port.
2. iPod input port.

The portable audio system is located in the centre console cubby box. You can connect a variety of audio devices, including iPods, via this interface to the audio system.

CAUTION

- ⚠ We recommend that you refit the rubber cover when a portable device is not plugged in. This will prevent damage to the system. The cover is not waterproof.
- ⚠ Please disconnect your iPod when leaving the vehicle. Failure to do so may result in the iPod battery discharging.

If you are connecting an iPod or mass storage device, you can use the touch-screen to operate and search the device. Many of the controls are similar to those available for CD play.

The devices that you can connect to the portable audio interface include:

- USB mass storage devices, for example memory stick.
- iPod.

Note: The portable audio interface supports the following iPods:

- iPod (generations 3-5).
- iPod Mini.
- iPod Nano (generations 1-3).
- iPod Photo.
- iPod Classic.

Note: The audio system will play MP3, WMA, WAV and AAC files.

Note: Some MP3 players have their own file system that is not supported by this system. To use your MP3 player, you must set it to USB Removable Device or Mass Storage Device mode (see manufacturer's information for further details). Only music that has been added to the device in this mode can be played via the vehicle's portable audio system.

Note: The system will support devices with a storage capacity up to 256 GB (approximately 65 000 tracks).

Portable audio

Connecting an iPod

On the audio Home screen, select **Audio**, then **Portable audio**, then **iPod**.

Note: You can also press the **SOURCE** button repeatedly to select **Portable audio device**.

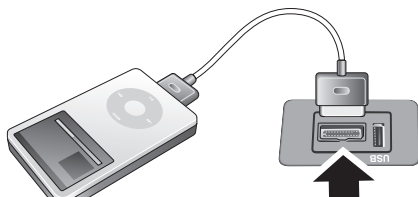

JAG1232

A dedicated iPod lead is supplied with the Portable audio interface. Plug in your iPod with the usual care necessary to protect the connector pins from damage.

Play will start automatically from the point at which the iPod was last played.

Connecting a USB device

On the audio Home screen, select **Audio**, then **Portable audio**, then **USB**.

Note: You can also press the **SOURCE** button repeatedly to select **Portable audio device**.

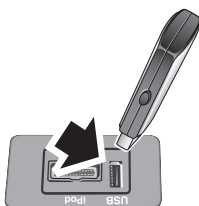

JAG1233

Insert the USB device into the socket indicated.

When connected, the first track in the first available folder is played automatically.

Note: We recommend that only music files are loaded on the USB device. This will speed up the automatic indexing of files.

Connecting more than one device

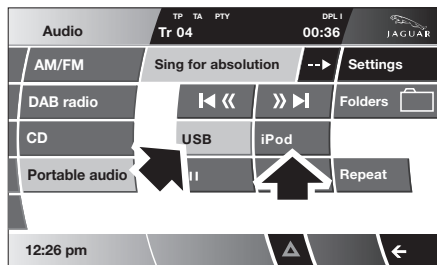

JAG1214

You can simultaneously connect an iPod and a USB device to the portable audio interface and switch between them using the touch-screen. Select **iPod** or **USB** to switch between modes.

The device docked first will remain the active device until you choose to change.

If, after changing to the newly-docked device, you change back to the first device, play will resume at the point you left it.

Note: You cannot use a USB hub to connect more than one USB device to the audio unit.

Note: Devices connected to the iPod and USB ports will be charged, but devices that are fully discharged will not play. Please disconnect your iPod when leaving the vehicle. Failure to do so may result in the iPod battery discharging.

Note: Options such as **Repeat** and **Mix** relate to the device currently playing, they will not apply to any subsequent device.

Portable audio

PORTABLE AUDIO DEVICES

Playing a portable device

Playback of auxiliary devices is controlled using the touch-screen controls.

Autoplay

Whenever a USB device is docked, play will start automatically at the first track in the first available folder.

For an iPod, play will always resume from the current track, whether previously docked or not.

Pause

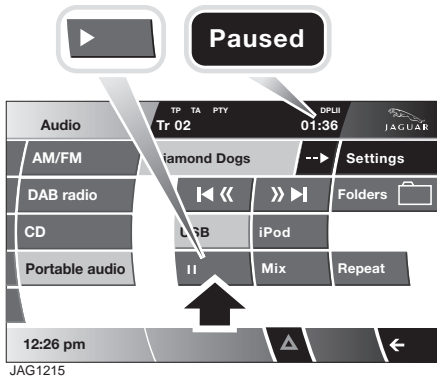

Select **II** to pause playback, select the button again to resume playback.

Mix

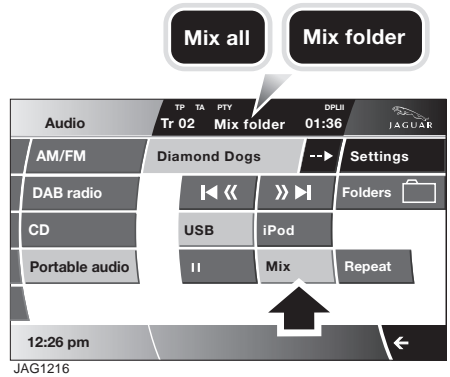

USB:

- Briefly touch **Mix** to play tracks in the current folder in a random sequence.
- Touch and hold (two seconds) **Mix** to play all tracks on the device in a random sequence.

iPod:

- Briefly touch **Mix** to play tracks in the current playlist in a random sequence.
- Touch and hold (two seconds) **Mix** to play all tracks on the iPod in a random sequence.

If the Mix option is active, select **Mix** to cancel it and return to normal playback.

Portable audio

Repeat

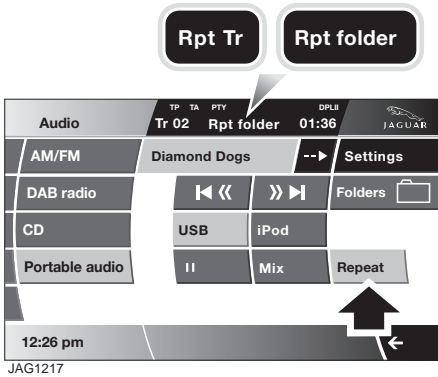

USB:

- Briefly touch **Repeat** to repeat play the current track continuously.
- Touch and hold (two seconds) **Repeat** to repeat all tracks in the current folder on a loop.

iPod:

- Briefly touch **Repeat** to repeat play the current track continuously.
- Touch and hold (two seconds) **Repeat** to repeat all tracks on the iPod on a loop.

Select **Repeat** again to cancel it and return to normal playback.

Displaying track information

Many tracks will be saved with additional information contained in an id3 tag. You can choose to display some or all of this information on the screen. The default display provides track title information only.

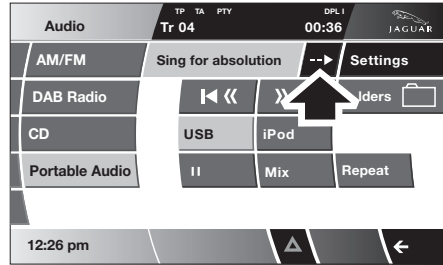

Briefly touch the --> button repeatedly to toggle through the information, including track title, artist, album and genre.

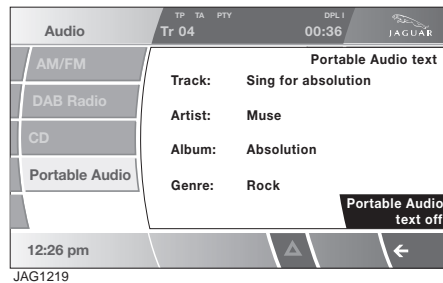

Touch and hold (two seconds) the --> button to display the **Portable audio text** pop-up screen providing all the id3 tag information available for the track.

If no information is available, the screen will display the text **No entry**.

Touch the pop-up screen to close it.

Portable audio

Searching a portable device

Next/previous track

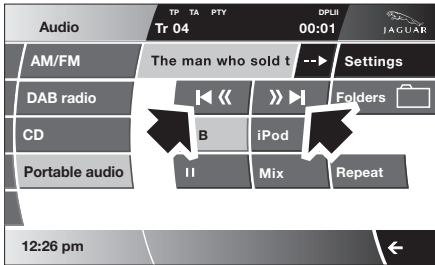

JAG1220

Briefly touch the seek buttons to move to the previous or next track.

If the **Mix** option is switched on, then the next track will be the next in the randomised playlist. In Mix mode, selecting previous will only return playback to the beginning of the currently playing track.

Fast forward/reverse

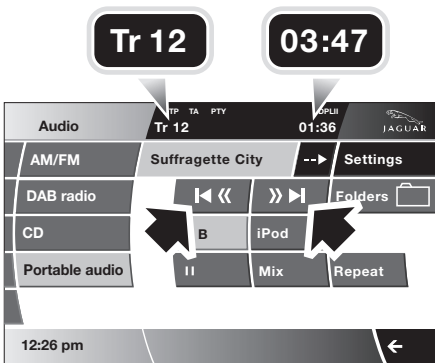

JAG1221

Touch and hold a seek button to fast forward or reverse through the current track. Release the seek button to resume normal play.

USB folders

The **Folder** option enables you to explore the folder structure on the USB device.

Note: Only compatible file types will be displayed on the touch-screen.

Note: We recommend that only compatible files are loaded onto the device. This will speed up the automatic indexing of your files.

Note: This feature is most useful when the files and folders on the USB device have been organised logically.

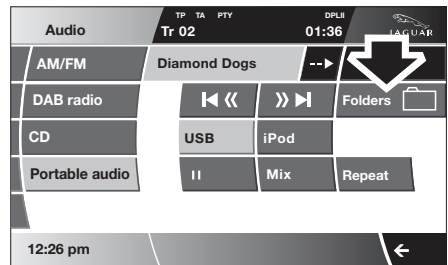

JAG1222

Select **Folders** to display all folders on the device.

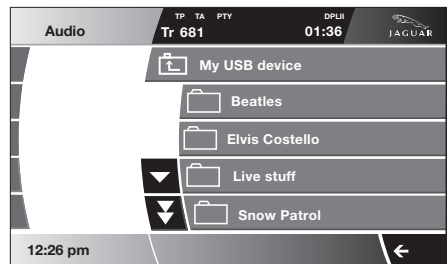

JAG1223

Select a folder name to display a list of tracks in that folder. Use the arrow icons (if displayed) to scroll through the list.

Portable audio

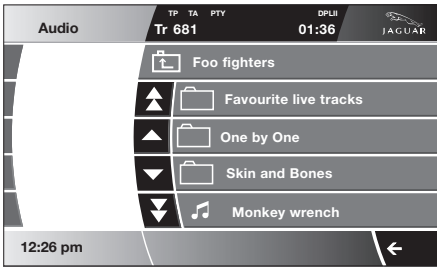

JAG1224

Select a track to start playback of that track. Play will continue as normal through the remainder of the tracks in that folder.

Select the open folder icon at the top of a menu to move back to the level of that folder.

iPod folders

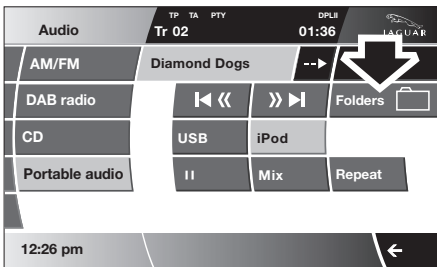

JAG1225

Select **Folders** to display all search methods available on the iPod. Search methods include, **Playlist, Artist, Album, Genre, Composer, Podcast, Audio Book** and **Song**.



JAG1226

Select a search method from the list to display a list of items found.

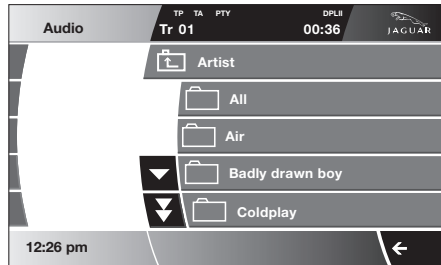

JAG1227

If you select **Artist**, a list of artists will be displayed.

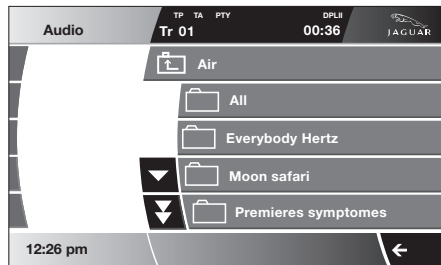

JAG1228

If you select an album title, a list of tracks is displayed. Select a track to start playback.

Select the open folder icon at the top of a menu to move back to the level of that folder.

Portable audio

Portable device settings

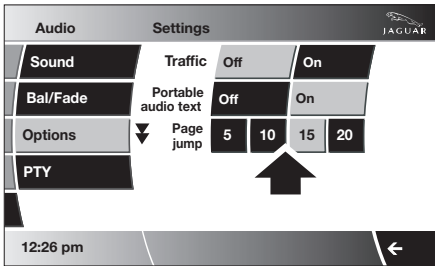

JAG1229

In Portable audio mode, select **Settings**, then select **Options**.

Traffic announcements

With **Traffic** enabled, traffic announcements (TA) will interrupt portable audio playback.

Portable audio text

With **Portable audio text** enabled, any text information saved on the device associated with a track, for example artist name, will be displayed on the touch-screen during playback of that track.

Page jump

Only five items are displayed on screen from a list of many items. If you select a single arrow scroll button, then four items will scroll past.

The **Page jump** setting helps you to navigate a very long list of items by setting the number of items scrolled through when a double-arrow page scroll button is selected.

For example, if you select **10** under **Page jump**, then 10×4 (40) items will scroll past each time you select a page scroll button.

Telephone

GENERAL INFORMATION

WARNING



Using the telephone near the car: Do not telephone inside a garage or near an open car bonnet. The air may contain fuel vapours and the telephone could produce sparks and start a fire.



Unusual ambient conditions: Switch off the telephone in areas where high explosives are being used. High frequency remote controls could be interfered with and cause an explosion. Switch off your telephone in areas with a high explosion risk. This includes filling stations, fuel storage areas or chemical factories, as well as places where the air contains fuel vapour, chemicals or metal dust. The telephone might produce sparks and cause a fire or explosion.



Medical equipment: The functioning of cardiac pacemakers or hearing aids may be impaired when the phone is in use. Check with a doctor or manufacturer whether any such devices you or your passengers are using, are sufficiently protected against high-frequency energy.



Always stow your mobile phone securely. In an accident, loose items can cause injury.



Using any hand-held appliance while driving, can be dangerous and is illegal in certain countries.

Note: The vehicle telephone system is designed to function with a wide variety of Bluetooth® telephones.

As these telephones have a wide range of audio and echo characteristics, it may take a few seconds for the vehicle telephone system to adapt and deliver optimum audio performance.

It may be necessary to reduce the in-vehicle volume slightly, to fully optimise audio performance and reduce echo.

Note: The vehicle's Bluetooth telephone system can be used with an appropriate Bluetooth-equipped mobile telephone.

Telephone networks

The telephone network standard allows you to use your telephone in many countries. However, telephone reception may be poor or unavailable in remote regions. This may be due to the inadequate power of the transmitter, which results in a weak signal or incomplete coverage.

Telephone

What is Bluetooth®?

Jaguar Bluetooth® Connectivity was developed to be used with a selected range of mobile phones, from a number of different manufacturers. Some mobile phones feature different operating software versions - the correct version is needed for successful integration with the Jaguar Bluetooth® system.

Bluetooth is an international standard that allows electronic components to communicate with each other, using a short-range radio link. Bluetooth eliminates the need for wires or cables: Typically, devices can communicate at a range of up to 10 metres (33 feet).

The Bluetooth in-car telephone system allows certain mobile phones to be used hands-free in your vehicle. There is no need to connect the mobile phone to a cradle or cable.

Bluetooth® is a registered trademark of Bluetooth SIG, Inc.

Please refer to the Ownership section of the Jaguar website at www.jaguar.com, for a list of compatible phones. Alternatively, please refer to your Dealer/Authorised Repairer.

Note: *The Bluetooth technology phones listed on Jaguar.com, have been tested for compatibility with Jaguar vehicles.*

Performance will vary, based on phone software version, coverage and your wireless carrier. Phones are warranted by their manufacturer, not Jaguar.

If your mobile phone battery charge becomes low, it may switch off its Bluetooth link to the vehicle. This is normal operation for mobile phones, to help preserve the remaining battery charge. In this event, the touch-screen will display a phone connection message.

The mobile phone must be paired and docked with the vehicle system before use. See **TELEPHONE PAIRING AND DOCKING** (page 286). Once paired and docked, the phone can be operated via the steering wheel switches or the touch-screen. The mobile phone does not need to be physically connected to the vehicle, it can be left in a jacket pocket, for instance. Calls are routed through the vehicle's audio speakers, and a dedicated microphone is fitted within the overhead console and is directionally biased towards the driver.

You can use the system to answer or reject incoming calls, make outgoing calls or alter the call volume. The system does not support SMS text messaging.

Note: *The ignition must be on and the touch-screen system must be active, in order to use the phone.*

Call volume

The volume of telephone calls can be adjusted for hands-free operation. To adjust the volume, operate the audio system's volume control during a phone call.

If the audio system is in use when the phone becomes active, the audio system source is suppressed for the duration of the call.

The Jaguar telephone system is designed to function with a variety of Bluetooth equipped mobile phones. The audio and echo characteristics vary between models of mobile phones. As a result, it may take a few seconds for the vehicle system to adapt to provide optimal audio performance.

In order to achieve the best possible audio performance, it may be necessary to select a lower speed on the heater blower and reduce the system volume slightly, when using certain mobile phones.

Telephone

Charging your phone

It is possible to use the in-car 12V auxiliary power socket or the USB connection to charge your mobile phone. Refer to the mobile phone operating instructions for charging information.

SAFETY

WARNING



Read the following information thoroughly before using your telephone.

Driving

Check local regulations covering the use of in-car telephones in the areas that you intend to use your telephone, and always obey them. Observe the following guidelines if you are using the phone when driving.

- Give full attention to driving - safe driving is your prime responsibility.
- Always use hands-free operation when driving.
- When receiving a call, if driving conditions demand, pull off the road and park.

Electronic devices

Most modern electronic equipment is shielded from Radio Frequency (RF) signals. However, certain equipment may not be shielded against RF signals from your phone.

Pacemakers

The Health Industry Manufacturers' Association recommends that a minimum separation of 15 centimetres (six inches) is maintained between a wireless phone antenna and a pacemaker, to avoid potential interference with the pacemaker. These recommendations are consistent with the independent research by, and recommendations of, Wireless Technology Research.

TELEPHONE PAIRING AND DOCKING

Before use, your mobile phone must be paired and docked with the vehicle's Bluetooth system. This is done via your mobile phone or the touch-screen.

Pairing and docking using your mobile phone

Follow the steps below, to pair and dock your phone with the vehicle using your mobile phone.

Note: *The process of pairing and docking your phone with the vehicle using the mobile phone, will vary depending on the type of mobile phone used.*

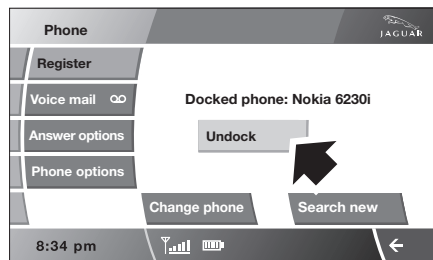

JAG1477

1. Ensure that the ignition is on and the touch-screen is active.

Telephone

2. Ensure that there is no mobile phone currently docked with the vehicle's Bluetooth system. If a mobile phone is docked with the system, you will not be able to pair and dock another phone until the current phone has been undocked. To undock a phone, select **Phone** on the home screen, then **Settings** and then **Undock**.
3. Using the mobile phone, search for Bluetooth devices. See your phone's operating instructions for further information.
4. When the vehicle's Bluetooth system is discovered, your mobile phone will list **Jaguar** as a Bluetooth device. Select this device from the list.
5. You will now be requested to enter a Bluetooth PIN. When pairing and docking from your mobile phone, this number is always 1313.

Once your phone is paired to the vehicle's Bluetooth system, it can connect automatically. If the phone does not automatically connect, you will have to connect manually with the Jaguar Bluetooth System, via the mobile phone. Please consult the mobile phone's handbook for further information.

Pairing and docking using the touch-screen

1. Switch on your mobile phone's Bluetooth connection, using the phone's menu. Make sure that your mobile phone is in Bluetooth discoverable mode, sometimes referred to as find me mode (see your phone's operating instructions for more information).
2. Switch the ignition system on, ensure that the touch-screen is active.
3. From the home menu, select **Phone**.

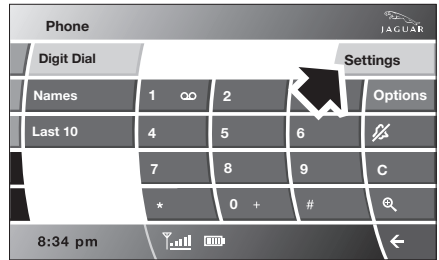

JAG1479

4. Select **Settings**.

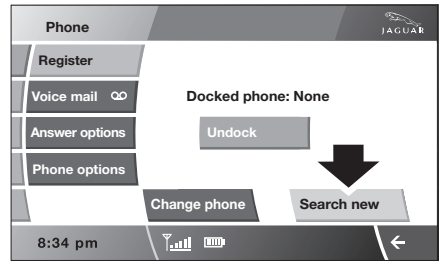

JAG1480

5. Select **Search new**. The system will search for all Bluetooth phones that are in range. If a phone is already docked, it will be automatically undocked when a Search is initiated.

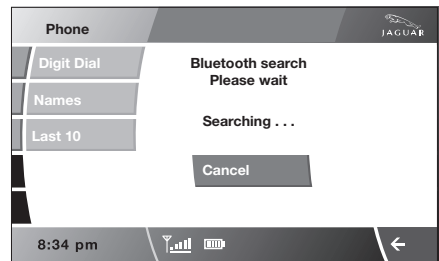

JAG1481

6. Select your phone from the displayed list.

Telephone

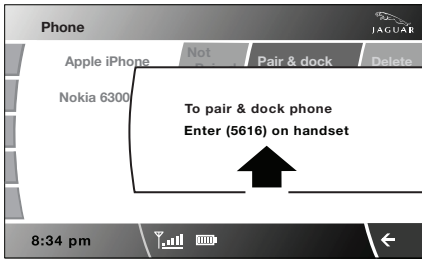

JAG1482

7. Once you have selected your phone, a pop-up window appears.
8. To pair and dock the phone, enter XXXX on the handset (XXXX being a random four digit code displayed on the touch-screen). Enter this into your phone (see your phone's operating instructions for more information).
9. Your phone is now paired and docked ready for use. See **MAKING A CALL** (page 293).
10. Once a mobile phone has been paired and docked with the vehicle, the system will search for the last connected phone, each time the ignition is switched on.

Note: Due to the duration of a Bluetooth search, it is advised that the timeout to home screen feature is switched off before attempting to search for Bluetooth devices. This setting can be changed within **Vehicle, Syst settings, Display set, Timeout to home screen**.

Note: You do not need to manually pair and dock the phone with the vehicle every time you switch the ignition on. If an incorrect code is entered, your mobile phone should prompt you to enter the correct code.

The Bluetooth system supports Bluetooth Hands Free Profile 1.5 (HFP 1.5). If the mobile phone paired to the system also supports this profile, additional features will be available such as battery meter, signal strength and network operator. If the mobile phone does not support these features, they will not be available on the touch-screen. However, you can refer to the mobile phone's display to determine these items.

Pairing other phones

Up to five mobile phones can be paired with the vehicle in the same way. However, only one can be docked for use. For further information, refer to **Changing or deleting the docked phone**.

Changing or deleting the docked phone

Only one phone can be docked to the vehicle at any one time. To dock a different paired phone to the vehicle, or to delete a phone from the system, follow the steps below:

1. From the home menu, select **Phone**.

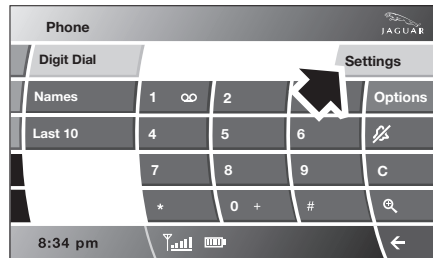

JAG1479

2. Select **Settings**.

Telephone

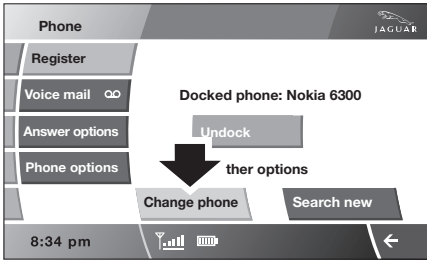

JAG1483

3. Select **Change phone**.

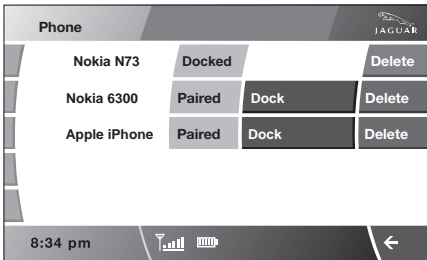

JAG1484

4. To change the phone, select **Dock** from the list of available phones.

To delete the phone, select the Delete button alongside the relevant phone on the list. To use the phone again, it will need to be paired and docked to the vehicle again.

Note: The phone does not need to be physically present, to be deleted from the list.

Register

From the Settings main menu, selecting **Register** gives the options to **Undock**, **Change phone** or **Search new**. For further information, refer to the following procedures - **Pairing other phones**, **Changing or deleting the docked phone**.

VOICE MAIL

You can set up your voice mail to be accessed via the touch-screen. The voice mail (network service) option is an answering service, where callers who are unable to reach you can leave messages.

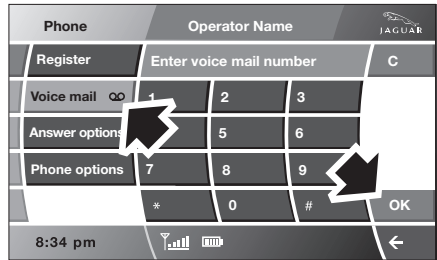

JAG1485

Select **Voice mail**, enter the number provided by your service provider and select **OK**. This number is stored in the system and used to retrieve any voice mail messages.

Retrieving voice mail



JAG1486

1 To listen to your voice mail messages, select and hold **1**.

The voice mail features can be used as if dialled from the mobile phone.

Telephone

ANSWER OPTIONS

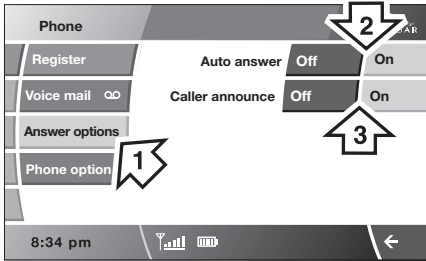

JAG1487

1. Select **Answer options**.
2. **Auto answer**: If automatic answer is on, the call will automatically answer after a few seconds. Select **Off** or **On**.
3. **Caller announce**: This feature, if available, allows the callers name to be announced. Select **Off** or **On**.

PHONE OPTIONS

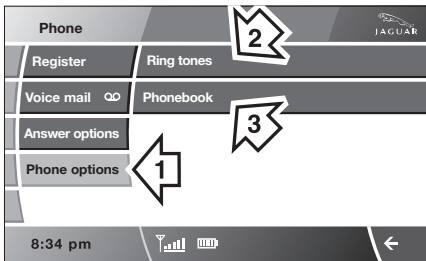

JAG1488

1. Select **Phone options** (1).
2. Ring tones (Ring tone options).
3. Phonebook (Phonebook options).

Ring tones

Four ring tones are available (for in-vehicle ringing) or you can use your mobile phone's own ring tone:

Select **Ring tones** (2). Select **Portable's inband tone** to use your mobile phones ring tone.

Note: Not all phones support inband ringing.

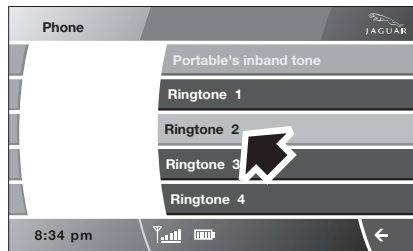
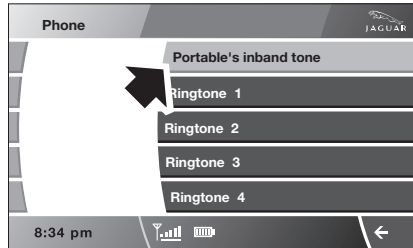

JAG1489

Or, select **Ring tone 1, 2, 3 or 4**, to use a Jaguar preset ring tone.

Note: The system will store the ring tone setting associated with each mobile phone.

Telephone

PHONEBOOK

The phonebook option (3), allows you to download your mobile phone's directory (either automatically or manually) or erase it from the vehicle's memory, assuming that the phone supports this feature.

The system can store a maximum of 750 entries, although this figure varies, depending on the type of mobile phone used. Refer to **Phonebook capacity**.

Note: It may take several minutes to copy the phonebook to the vehicle, depending on the phone and number of entries stored. The telephone system may not be operational during this period.

Automatic download

Any phone numbers stored in your mobile phonebook, can be copied to the vehicle's phonebook.

If **Auto Download** is on, the mobile phone phonebook will be transferred to the vehicle every time the phone is connected (docked).

This feature will only work on phones that support AT Phonebook Profile. Refer to your phone's operating instructions.

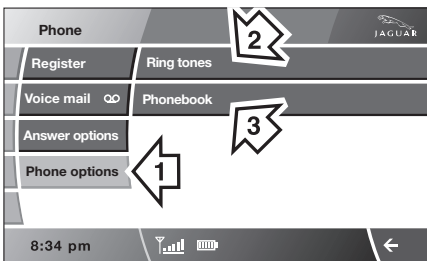

JAG1488

To change Auto Download: Select **Phone options** (1), then select **Phonebook** (3).

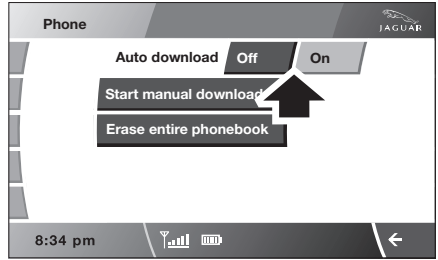

JAG1490

Select **Off** or **On**.

If **On** is selected, the vehicle will automatically download the entire directory, each time the phone is docked.

Manual download

If your phone does not support AT Phonebook (automatic phonebook download), you may be able to manually send your phonebook (individual entries or in full) to the vehicle's Bluetooth system using the phone's Object push facility. Refer to your phone's operating instructions to determine whether this feature is available.

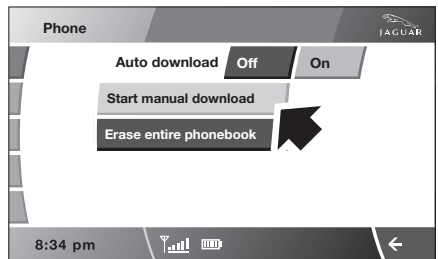

JAG1491

To initiate a manual download, select **Phone options**, then **Phonebook** and then **Start manual download**.

Telephone

The Bluetooth system will disconnect the currently docked phone and will be able to receive phonebook data sent from that phone. Please refer to your phone's operating instructions for details of how to send phonebook data using Bluetooth.

Once the phonebook data has been sent, select **Exit** to reconnect the last docked phone.

The vehicle's Bluetooth system will now display the manually downloaded phonebook data. For more information, refer to your phone's operating instructions.

Note: *This feature only allows you to send phonebook data from the last docked phone. You cannot download data from the Bluetooth system to a mobile phone.*

Once a paired phone is deleted from the paired phone list, the phonebook data associated with this phone is deleted.

Erase entire phonebook

To erase the entire phonebook:

Select **Phone options (1)**, then select **Phonebook (3)**.

Select **Erase entire phonebook**.

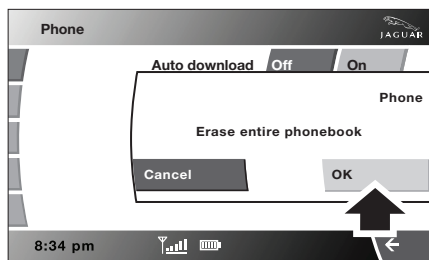

JAG1492

A pop-up window alerts you that you are about to **Erase entire phonebook**. Select **OK** to remove all names from the vehicle phonebook.

To delete one or more names, but not all, refer to **Deleting names from the Directory**.

Note: *This feature deletes phonebook entries stored in the vehicle memory and not those stored in the mobile phone memory.*

Phonebook capacity

Certain mobile phones store the phonebook in two different areas, the SIM card and the phone memory. Where possible, the vehicle will display both SIM card and phone memory entries up to a maximum of 750. With some mobile phones, the number of entries from one or both of these areas may be restricted. It is not always possible to transfer addresses stored in one or both of these areas.

The number of entries displayed is dependent upon the number of SIM and phone memory entries supported by the mobile phone.

Note: *Certain mobile phones do not allow phonebook entries stored on the SIM card to be transferred via Bluetooth. However, it may be possible to transfer the SIM phonebook to the mobile phone's memory, before copying it to the vehicle phonebook. Refer to your mobile phone operating instructions for more information. It is advisable to remove duplicate and blank entries from the mobile phone, before the phonebook is downloaded.*

Telephone

MAKING A CALL

Before you make a call, your mobile phone must be paired and docked with the vehicle's Bluetooth system.

From the Home menu, select **Phone**.

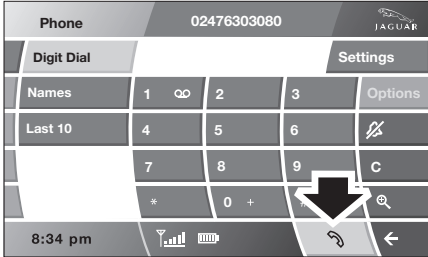

JAG1493

Key in the phone number, including the area code, if applicable - the number will be displayed. Touch the **connect** icon.

Changing a phone number

When entering a number, you can change the phone number shown on the touch-screen using the **C** button.

A momentary touch erases a single digit, a long touch erases the complete number.

Receiving a call

If the audio system is in use when the phone becomes active, the audio system source is suppressed for the duration of the call.

If automatic answer has been programmed, the call will automatically answer after a few seconds. See **ANSWER OPTIONS** (page 290).

To answer a call: The preferred method to accept an incoming call, if Automatic answer is not active, is to use the hands-free controls on the steering wheel. See **HANDS-FREE CONTROLS** (page 296). Alternatively, you can accept or reject the incoming call, from the pop-up displayed on the touch-screen.

Ending a call

The preferred method to end a call is to use the hands-free controls on the steering wheel. See **HANDS-FREE CONTROLS** (page 296).



JAG1494

Alternatively, select the End call icon (arrowed).

Continuity of calls

Whilst in a call, the call remains connected if the vehicle is in convenience mode. When the call ends, another call cannot be made or received through the vehicle system, unless the ignition is on and the touch-screen system active.

Telephone

NAMES

Directory name search

From the Home menu, select **Phone**.

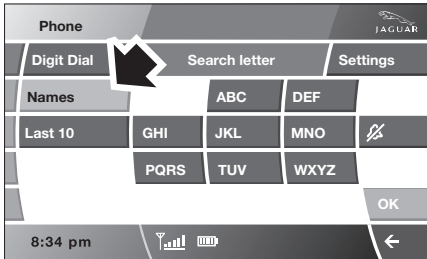

JAG1495

Select **Names**.

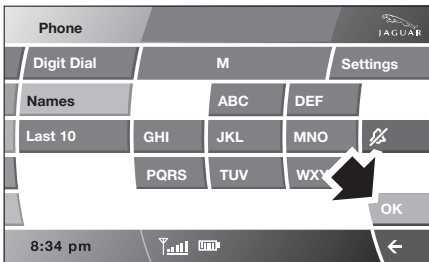
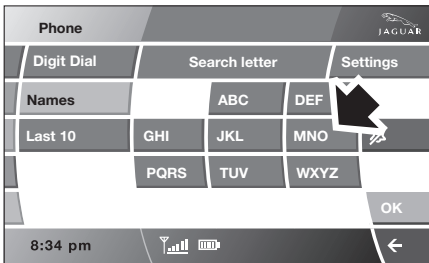

JAG1496

1. Select the first letter of the contact name. If the name begins with the second or third letter on the button, touch the button two or three times respectively (i.e. if the name begins with an F, touch the **DEF** button three times).

2. Select **OK**.

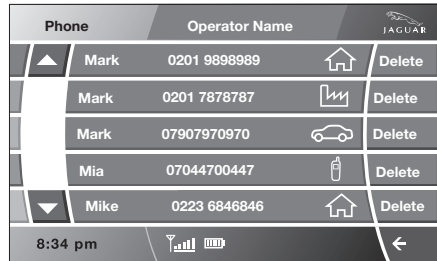

JAG1497

Select the desired name to make a call.

Note: Using the hands-free controls, you can search the phonebook via the message centre.

Directory contact types

If your phone supports contact type data, you will be able to see a contact type icon in the vehicle's phonebook directory. These can be seen on the right-hand side of each contact in the directory and will indicate one of the following types:



Work.



Home.



Mobile.



Car.

Telephone

Deleting names from the directory

From the Home menu, select **Phone**.

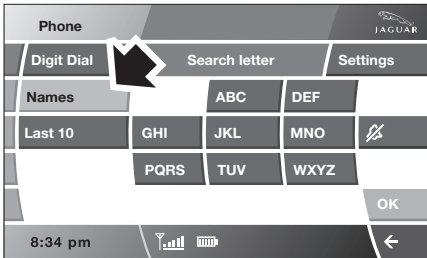

Select **Names**.

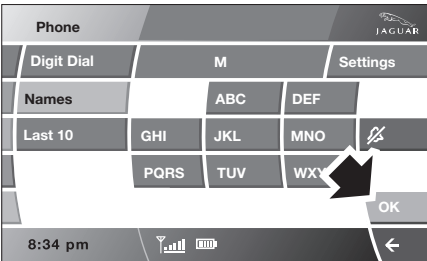
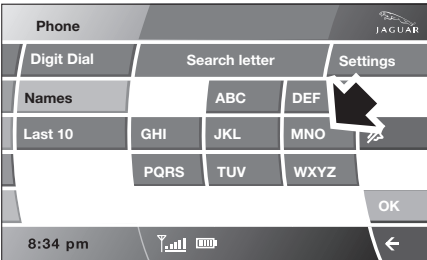

1. Using the keyboard, select the first letter or letters of the contact name to narrow your search. The selected letter(s) appears in the upper display.
2. Select **OK**.

The search fields are opened and matching contacts are listed.



Select **Delete** to remove a name(s) from the phonebook.

Telephone

LAST 10 OPTION

The Last 10 option allows you to view the last 10 calls made, received or missed.

From the home menu, select **Phone**.

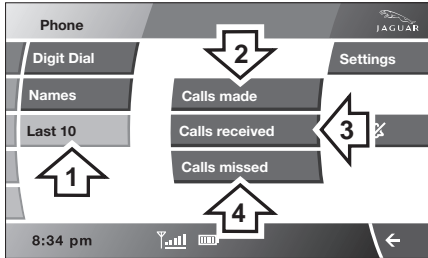

JAG1499

1. Select **Last 10**.
2. Select **Calls made** or.
3. Select **Calls received** or
4. Select **Calls missed**.

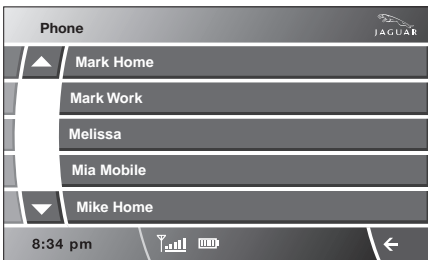

JAG1500

The search fields are opened and a list of the calls made, received or missed are listed, with the most recent at the top.

To make or return a call, select the name from the list. Your call will be routed automatically.

Note: The vehicle will display the list in the order that they are sent from the mobile phone. Some phones may arrange the list in reverse or other order.

HANDS-FREE CONTROLS

Four system adjustment controls are situated on the left-hand side of the steering wheel, duplicating functions of buttons on the touch-screen. Using these buttons is the preferred method of adjustment, as driver distraction is minimised.

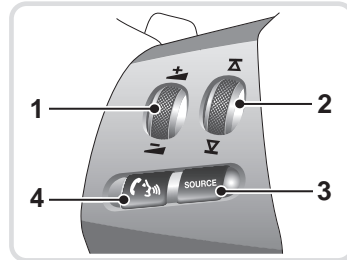

JAG1509

1. Scroll up/down to increase or decrease volume.
2. Scroll up/down to next/previous memory location.
3. Source. Press and hold to access phone mode on the touch-screen and message centre.
4. Call button. Briefly press to initiate or end a call.

Telephone

Phonebook scrolling using message centre

Press and hold the Source button on the steering wheel, to scroll through and select a phonebook contact via the message centre.

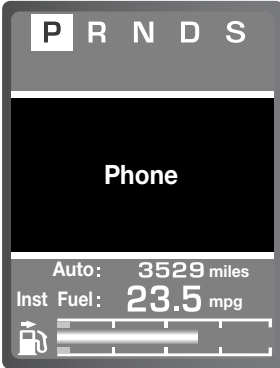

E96934

Phone will be displayed and the Phonebook can be accessed on the touch-screen.

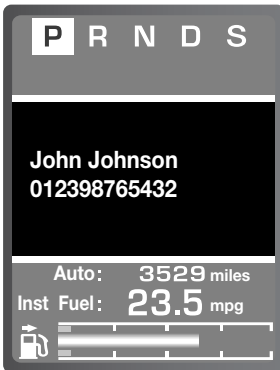

E96958

Use the scroll up and down buttons to search through the Phonebook. Each entry will be shown in the message centre.

With the required contact displayed, press the Voice button on the steering wheel to make the phone call.

Making/ending a call

To dial:

Key in the phone number, including the area code. The number will be displayed.

To connect:



Press this button on the steering wheel, or



Touch this icon on the touch-screen.

To end a call:



Press this button on the steering wheel, or



Touch this icon on the touch-screen.

OTHER FEATURES

Keyboard magnification

This option allows the user to increase the keyboard size.

When making a call using the numerical keypad displayed on the touch-screen, the Magnify icon becomes selectable.



JAG1501

Select the Magnify icon to enlarge the keypad.

Telephone

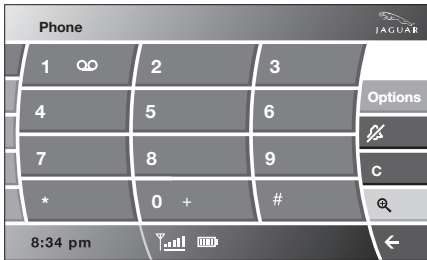

JAG1502

Select the Magnify icon again to reduce the size.

Do not disturb mode

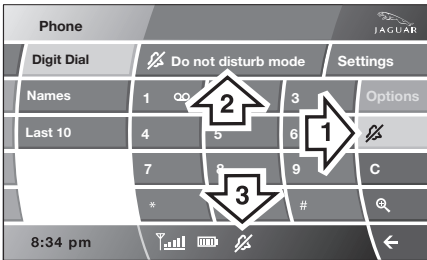

JAG1503

If you do not wish to be disturbed by incoming phone calls, select the bell icon (1) on the touch-screen. A visual representation will be displayed on the touch-screen, to advise the driver that the Do not disturb mode is selected (3) and **Do not disturb mode** will be visible when in telephone mode (2). Any incoming calls will be rejected or diverted to voice mail.

Navigation system

THE NAVIGATION SYSTEM

WARNING



In the interests of road safety, only operate, adjust or view the system when it is safe to do so.

Loading the navigation DVD

Note: Before use, ensure that the navigation DVD player is loaded with the correct mapping DVD for your country.

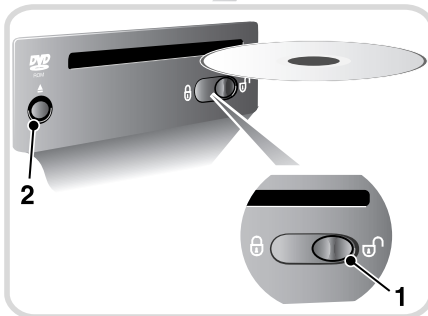
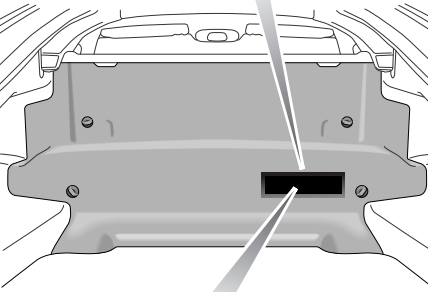
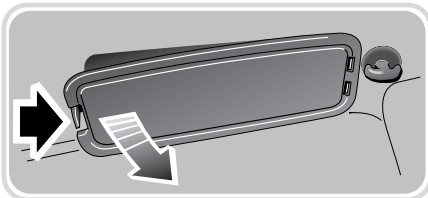

JOL4505G

CAUTION



Do not allow moisture, dirt or foreign objects to enter the slot.

The navigation DVD player is located behind an access panel in the luggage compartment. Remove the trim panel (as shown) to access the DVD player.

- Turn on the vehicle ignition.
- Move the lock/unlock button to the unlock position (1).
- Press the unload button (2) to eject a DVD, if one is installed in the DVD player.
- Load the correct Navigation System DVD with the printed side upwards.
- Move the lock/unlock button to the locked position. Replace the access cover.

SATELLITE SIGNALS

The system uses signals from the Global Positioning System (GPS) satellites, which allow the approximate position of the vehicle to be calculated. This is combined with information from vehicle sensors and data from the Navigation DVD, to establish the true vehicle position.

The navigation computer then integrates this data with the information stored on the DVD, enabling you to plan and follow a route to your desired destination.

Navigation system

Digitised area

Ensure that you are using the latest version of the correct DVD for your country.

Note: *Your Dealer/Authorised Repairer will have details of how to order DVD updates.*

The navigation DVD provided, contains a digitised street map. Larger cities and boroughs are completely covered. The regional and unclassified roads or access roads and the town centre for smaller towns and boroughs are included.

One way streets, pedestrian zones, turn bans and other traffic regulations are taken into account as far as possible. There may be discrepancies between the data on the navigation DVD and the actual local situation, due to temporary or permanent changes to road systems and their traffic regulations.

If the vehicle battery has been disconnected, or if the vehicle has been transported to a new location on another vehicle (e.g. by trailer or train), the navigation system may require several minutes to identify the new position.

Errors in vehicle position

Under certain driving conditions, it is possible that the vehicle position shown may be incorrect. Some examples are shown below:

- Negotiating circular ramps in car parks.
- Elevated roads in proximity to other roads.
- Where two roads run parallel to each other.
- Driving on steep roads.
- When the vehicle is transported by ferry or train.
- After the tyres have been replaced.
- When using snow chains.
- After the vehicle has been rotated on a turntable.
- After vehicle battery removal or supply fuse failure.

Reception of GPS signals

GPS signals are highly directional and reception may occasionally be interrupted. Some examples of situations likely to cause problems are shown below:

- Inside buildings.
- Forest roads between mountains.
- Between tall buildings.
- Roads under cliffs.

The vehicle's direction and speed sensors will minimise any adverse effect on the operation of the navigation system, if this should occur.

Normal operation will resume once the obstruction has been passed.

Navigation system

GETTING STARTED

If the screen is already displaying another function (radio, phone, etc.), touch either the back arrow or the **Home** button below the touch-screen to access the Home Menu.

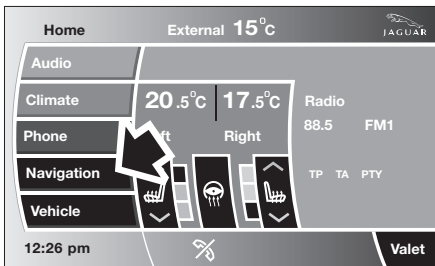
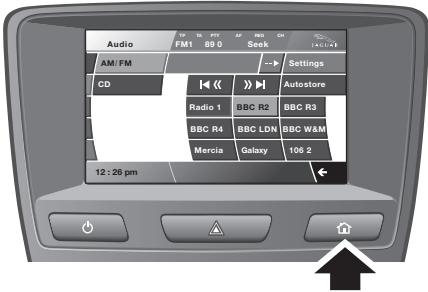

JAG1460

Select **Navigation**.

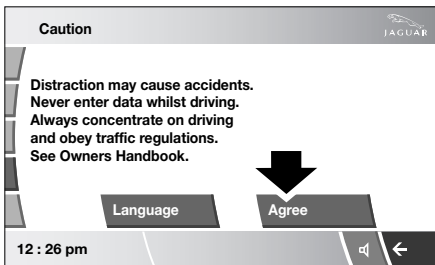

JOL4500ENG

Read the caution and touch **Agree** or select **Language** if you need to select a different navigation language.

Non-European countries only

The introduction screen text for non-European countries is as shown below and not as seen on the previous illustration:

“Most functions are inhibited whilst the vehicle is in motion. Please read the handbook for operating instructions. Always obey traffic regulations.”

Note: *In some countries, the front seat passenger may enter data whilst the vehicle is in motion.*

Navigation system

MENU STRUCTURE

The following menu outlines the touch-screen **Navigation** system menu structure.

Navigation Setup	User Settings	
	Quick POI Selection	
	Calibration	
	Restore Defaults	
	RDS-TMC	
	Language Selection	
Stored Locations	Memory	Add
	Destination/waypoint	Edit
	Previous	Delete
	Avoid Points	
	Home	
Destination Entry	Address	House
		Street
		Town
		Intersection
		Display Map
		Search
		Save
	POI	POI Name
		POI
		Phone
	Postcode	
	Map	
	Coordinates	
Route Options	Route Preferences	
	Destination/Waypoint	
	Detour	
	Search Condition	
	Route Preview	
	Display Route	
	Calculate	
	Cancel Guidance	
	Route Trace	
Auto voice guidance off		

Navigation system

MAIN MENU

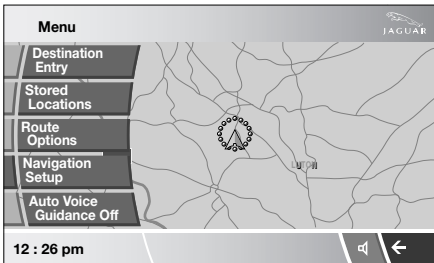

JOL4506ENG

After selecting navigation, the main menu is displayed showing available functions. For detailed information on these items:

See **DESTINATION ENTRY** (page 317).

See **STORED LOCATIONS** (page 315).

See **ROUTE PREFERENCES** (page 310).

See **USER SETTINGS** (page 303).

See **VOICE GUIDANCE** (page 312).

There are additional sections in this handbook specifically showing Points of Interest (POIs) and End User Licence Agreements.

Select the menu item required.

Note: To view the map without the buttons showing, touch anywhere on the map display. To display the buttons, touch **Menu**.

USER SETTINGS

From the main navigation menu, select **Navigation Setup**, then select **User Settings**.

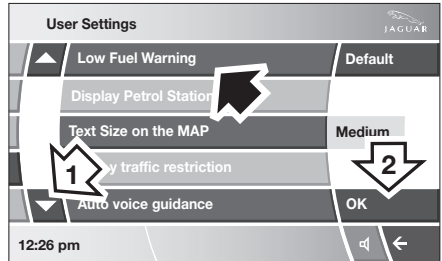

JAG1582

Use the scroll arrows (1) to view all options.

Most of these selections are either on or off (light blue band is not selected, dark blue band is selected).

Touch to select those which you require, then select **OK** (2).

Note: Touch a light blue band to select that feature or a dark band to deselect it.

Navigation system

LANGUAGE SELECTION

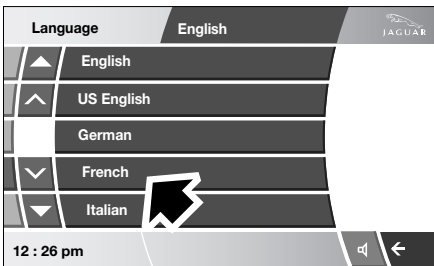
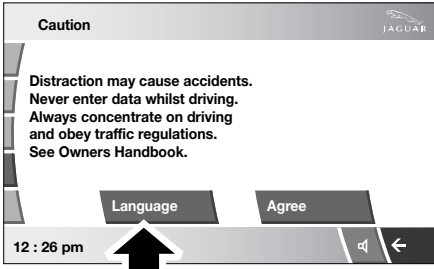

JOL4501ENG

From the initial navigation screen, select **Language**, then make your selection from the displayed list.

If necessary, use the scroll arrows to the left of the list to search up or down.

MEASUREMENT UNITS

Distances shown on the screen and given in voice guidance, are either in metric units (kilometres and metres) or in Imperial units (miles and yards) and can only be changed from the vehicle touch-screen menu, not from the navigation system menu.

To change the measurement units, select **Vehicle** on the vehicle touch screen, then select **Unit Change**.

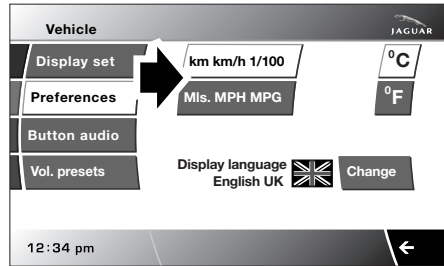

JOL4657ENG

Select your preference, by touching either **km km/h 1/00** or **Mis. MPH MPG**.

KEYBOARD LAYOUT

The keyboard layout can be changed from a QWERTY type to ABCDEF type.

- Select **Navigation Setup** from the main navigation menu.
- Select **User Settings**.

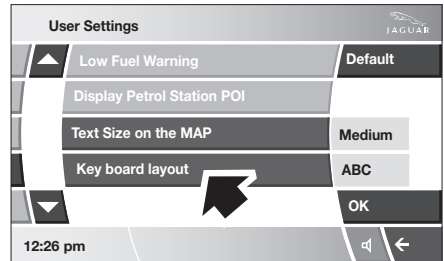

JAG1576

Touch the button (arrowed) to change the keyboard layout, then select **OK**.

Navigation system

MAP SPLIT SCREEN

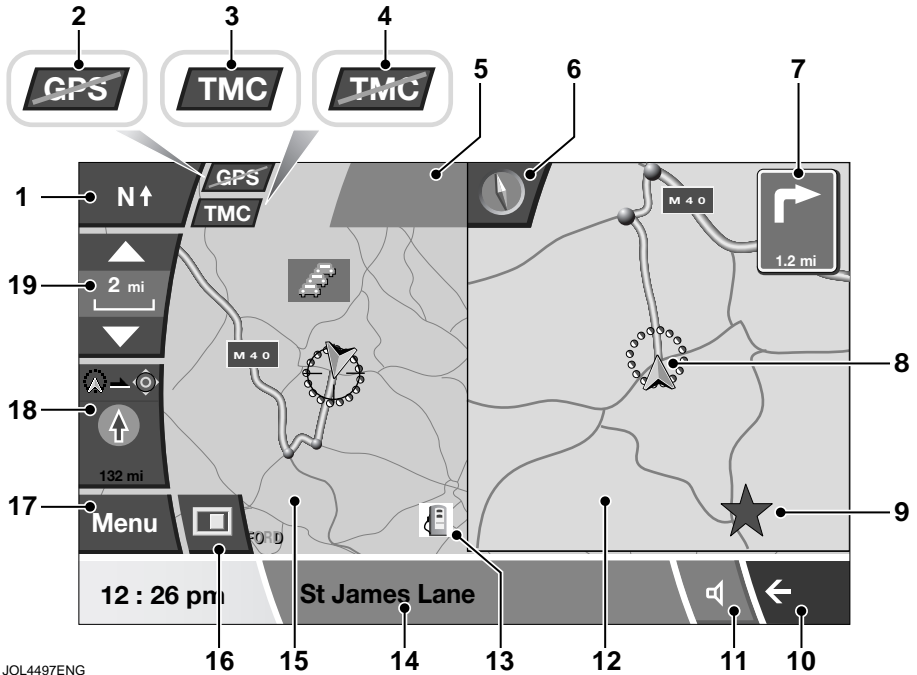

JOL4497ENG

1. North is up.
2. GPS (Global Positioning System) a signal is not being received.
3. TMC (Traffic Master Channel), a signal is being received.
4. TMC, a signal is not being received.
5. Message box.
6. Small compass display which always indicates North.
7. Next direction display.
8. Current vehicle position.
9. TMC Incident (Red Star).
10. Back one screen arrow.
11. Repeat last voice instruction.
12. Split screen.
13. Second screen scale display.
14. POI - fuel station shown.
 - The POI button will not be active if the zoom level is above 1 km (½ mile).
15. Current street location.
16. Normal screen.
17. Screen mode selection.
18. Menu.
19. Distance display.
20. Zoom and scale display.

Navigation system

MAP DISPLAY ICONS

The icons on the split screens are:



This is only displayed when a satellite signal is not being received.



This icon is displayed when TMC is selected and a signal is received.



When the bar is across the TMC, then a signal is not being received and TMC will not function.



Touching this icon toggles it with the N (North) icon (1). The compass always points North or else the vehicle direction arrow always points to the top of the map.



Distance and direction for the next turn.



If the compass icon (6) is showing, the vehicle direction icon (8) is always to the top of the map irrespective of where North is.



Example RDS-TMC Icon (this one showing incident).



Go back one screen.



Touch to repeat last voice instruction.



Example POI (this one showing a fuel station).



This icon shows information concerning journey distance and the estimated time remaining before arriving at your destination.

It also indicates your journey from your current position to the next waypoint or to your destination. In this example the journey is to your destination, shown in the top of the icon as the vehicle position arrow and a pointer towards a red circle.



This icon shows distance from your current position, distance and direction to way point 2.



This is your zoom button, enabling you to alter the map scale. The current level of zoom is shown between the two arrows (e.g. 2 miles). You may also see a zoom bar on the map.



This icon is toggled with the compass (6). When this is showing, North is always to the top of the map.



This icon is visible when the navigation screen has been scrolled away from the current vehicle position, so that the vehicle (compass) icon is no longer visible. Touch the icon to re-centre the screen on the current vehicle position.

Navigation system

Other icons

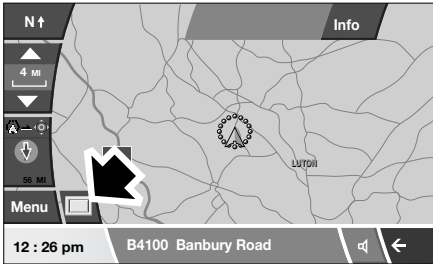

This displays a larger next junction guidance arrow on the right screen.



This facility is only available when travelling on a motorway and appears automatically to display the remaining motorway exits (up to the required exit for your route) and the exit numbers.



Automatically shows the next junction on the right of the screen.

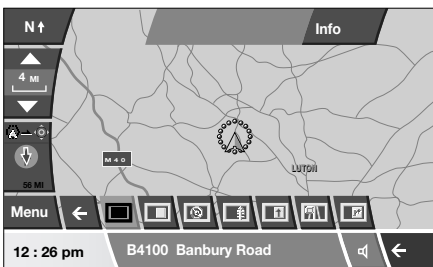

JOL4528ENG

Other icons can be shown to select different views of the screen(s). Touch the button, arrowed above, to show the icons for selection.



Show full screen.



Show the split screen.



Show the compass.



List of forthcoming junctions and turn directions shown on the split screen.

Navigation system

SEARCH AREA

Some map databases are divided into countries, or in the case of some larger countries, into areas of countries, called Search areas. When setting a route, the destination (or waypoint) being entered must be in the currently selected search area.

The first time the navigation system is used, the driver should confirm that the correct country/area has been selected. Once set, it will remain correct for all future use, unless either battery is disconnected, or a destination in an alternative search area is entered.

Setting the search area

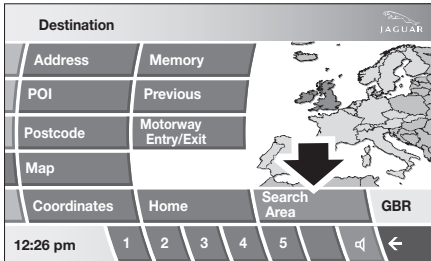

JAG1575

From the main Navigation menu, select **Destination entry**. The map on the screen will show the currently selected search area.

To change the search area:

- Select **Search Area**.
- Use the arrow icons to scroll through the list and select the three letter code that corresponds with the desired country/area.

The country/area name will be displayed in full, below the map.

- Select **OK**. The screen returns to the Destination menu.

SETTING A DESTINATION

Select **Menu** from the navigation map screen.

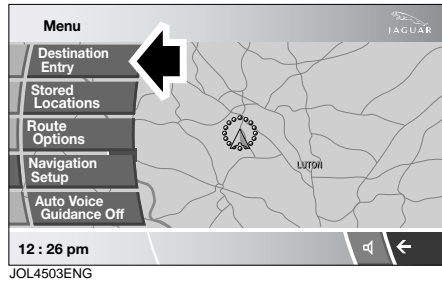

Select **Destination Entry**.

Note: If you wish to view the map without the buttons showing, touch anywhere on the map display. To display the buttons, touch **Menu**.

If at any time you make a mistake, use the back arrow key in the bottom right hand corner to either go back one letter or number at a time or repeatedly touch it until the previous screen is shown.

The Destination Entry menu provides a choice of methods for entering a destination:

- Address.
- POI (Points Of Interest).
- Postcode.
- Map.
- Coordinates.
- Memory.
- Previous.
- Motorway.

Navigation system

Setting an address as a destination

For this example, the destination address, 81 Austin Place, Abingdon, Oxfordshire will be used.

- From the Destination screen, select **Address**.
- Select **Town**.
- Select **Town Name**.

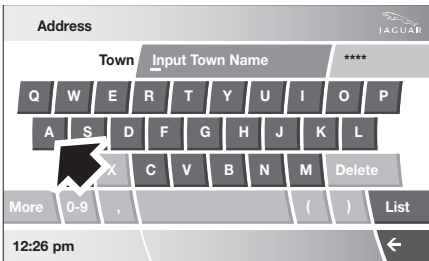

JAG1577

Input the destination town name using the keypad. Only letters which are highlighted can be used. Delete incorrect letters by touching the back arrow.

Once sufficient letters have been inputted the system will display all the possible towns.

If necessary, use the scroll arrows to the left of the list to search up or down.

Select (touch) the town you require.

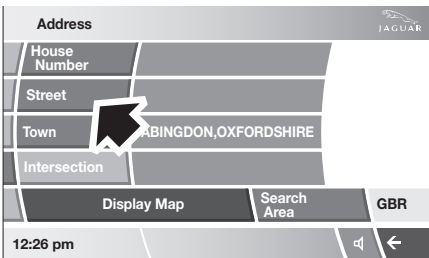

JAG1578

Select **Street**. Enter the street name in the same way as the town name was entered.

When the system recognises enough letters, the street or a list of streets will be displayed.

Select the street you require.

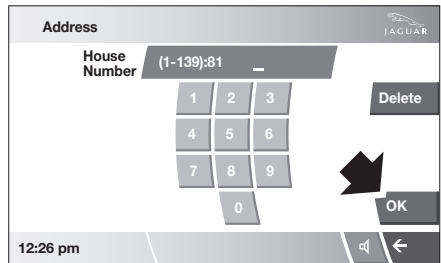
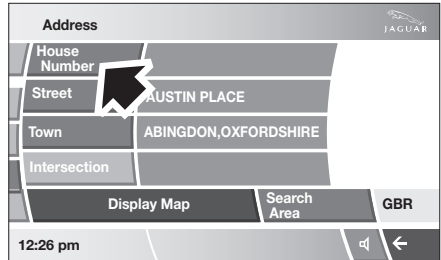

JAG1579

Select **House Number**, then use the numeric keypad to enter the house number of the address, then select **OK** to confirm.

If the house number is not known, select **OK** - the mid-point of the street is then used as the destination.

Note: If a list of house number ranges is displayed, select the applicable range and then enter the number.

Navigation system

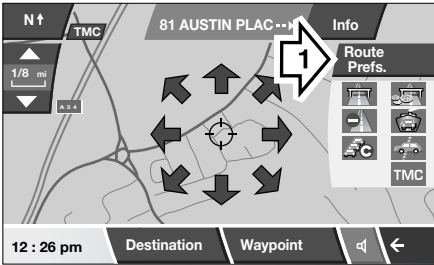

JOL4540ENG

Once the address has been entered, the map screen showing the route settings and destination details is displayed.

Touch **Route Prefs.** (1) to change the route settings or **Destination** to start the route calculation. If a destination is already set, touch **Waypoint** to add the entered address as a waypoint in the journey.

ROUTE PREFERENCES

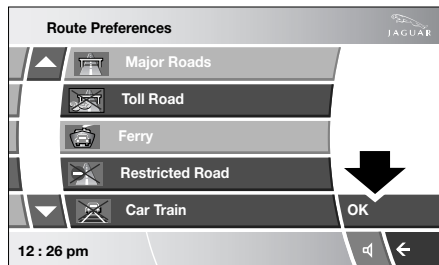
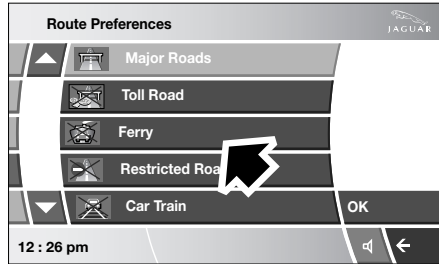

JOL4541ENG

If **Route Prefs.** is selected, the route preferences screen will be displayed. select the desired option(s) and select **OK** to confirm.

Note: Touch a dark blue band to select that feature or a light blue band to deselect it.

Navigation system

START GUIDANCE

After touching **Destination**, the system will calculate the route (**Searching route...** is displayed).

There is now a choice to select **3 Route**, **Change Route** or to **Start** (navigation guidance).

Select **3 Route** to view a choice of three different routes to your chosen destination.

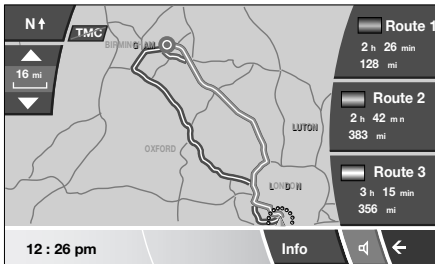

The three routes are shown in three different colours. Three corresponding boxes showing the route details, are also displayed.

Select route **1**, **2** or **3** by touching the appropriate box.

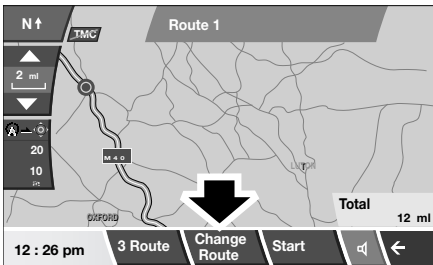

Touch **Change Route** to select an alternative route or route options.

When you have chosen your route and route options, select **Start**.

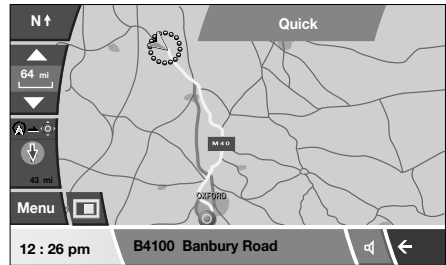

The route will be highlighted on the map, with an arrow icon showing your current position and a circle within a red circle showing your destination. The road name/number is also listed in the text area below the map.

When it is safe to do so, drive away, following the voice guidance given by the system.

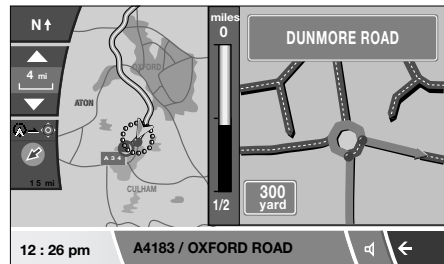

As you approach a junction, in addition to the voice guidance, an inset on the map will display an enlarged view of the junction.

Turn-by-turn information is also given in the message centre in the instrument pack.

When your destination is reached, voice and visual confirmation is given.

Navigation system

VOICE GUIDANCE

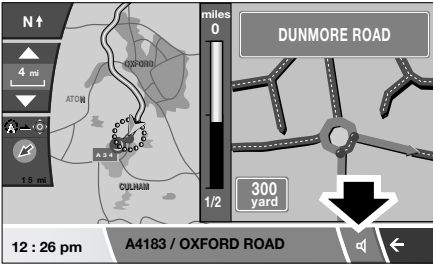

JOL4545ENG

To repeat the last voice guidance message, touch the speaker icon.

To turn voice guidance on or off, but still maintain visual route guidance, proceed as follows:



JAG1580

Go to the **Navigation Menu**, then select **Auto Voice Guidance Off**. This can also be done using the User Settings menu.

Note: The repeat voice guidance facility (the speaker icon) is still available when voice guidance is muted.

CANCEL GUIDANCE

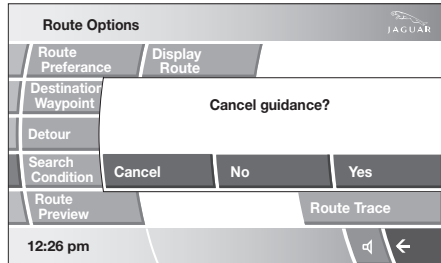
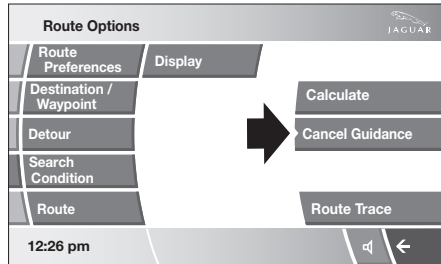

JAG1583

- Select **Route Options** from the main navigation menu.
- Select **Cancel Guidance**.

A confirmation pop-up screen is displayed. Select **Yes** to cancel guidance.

Navigation system

QUICK POI SELECTION

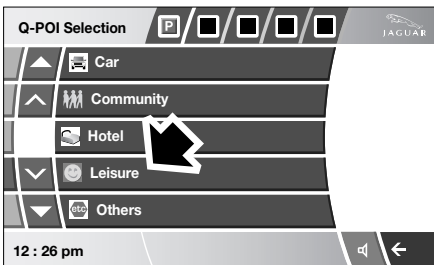
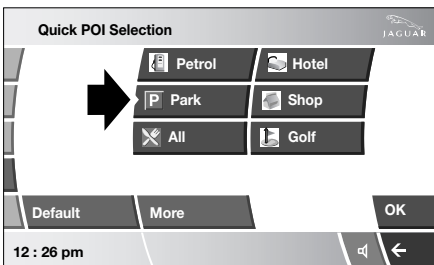
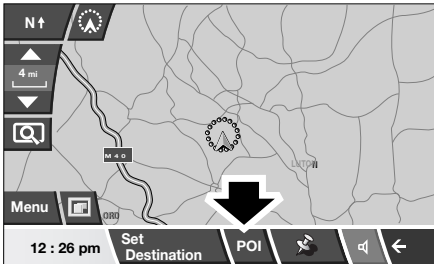

JOL4508ENG

- Touch the map screen to display the POI button.
- Touch the **POI** button. The screen shows six suggested categories that can be selected as quick points of interest.

Note: The POI button will not be active if the zoom level is above 1 km (½ mile).

- Select a Quick POI category, or select **More** to see further POIs and then select List all Categories, to view all available options.

- Select the five POIs you wish to see when the Quick POIs are displayed.
- Select **OK**. The map screen with the POI icon(s) is displayed.

CALIBRATION

If the vehicle has been moved without being driven (e.g. by rail or trailer), the vehicle position/direction may need to be recalibrated.

If the tyres have been changed, the distance measuring system used by the navigation system will need to be recalibrated

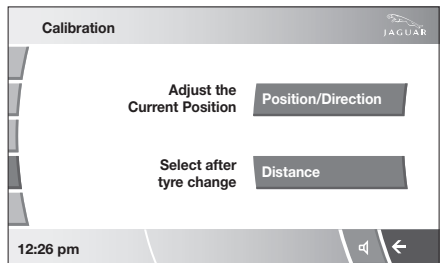

JAG1584

- From the Navigation menu, select **Navigation Setup**.
- Select **Calibration**.
- Select the **Position/Direction** button if the vehicle has been moved.
- Select the **Distance** button if the tyres have been changed.

Navigation system

Position/Direction

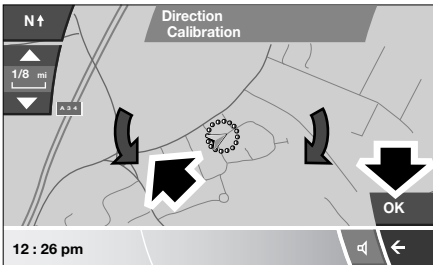
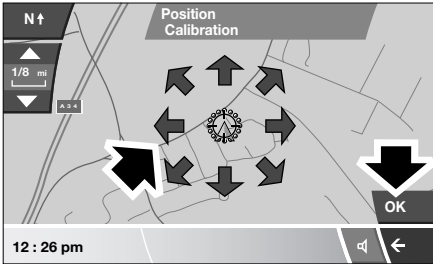

JOL4509ENG

The map showing the heading adjustment arrows is displayed.

Adjust the heading, by touching the appropriate arrows, until the navigation symbol shows the correct position and alignment on the map. Select **OK** to confirm.

RESTORE SYSTEM DEFAULTS

If you have made any changes to the system default settings, speed settings etc. then this will restore the original settings.

- From the Navigation menu, select **Navigation Setup**.
- Select **Restore Defaults**.

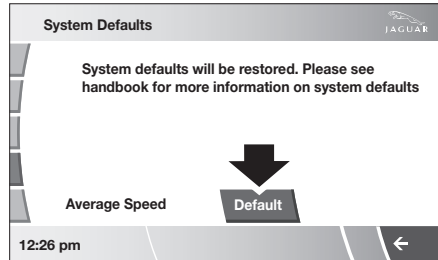

JAG1585

- Select **Default**.

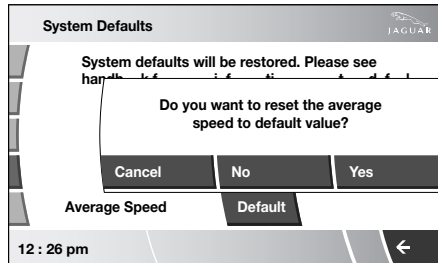

JOL4549ENG

- Select **Yes** to confirm.

Navigation system

LANGUAGE SELECTION

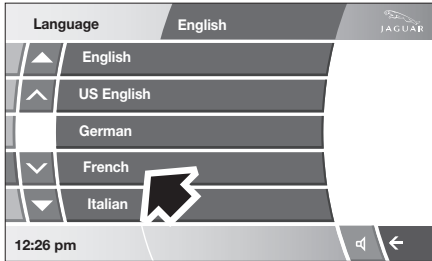

JAG1586

Language change can be made from the map screen, or as follows:

- From the Navigation menu, select **Navigation Setup**.
- Select **Language Selection**.
- Use the arrow icons to scroll down the list and select the desired language.

STORED LOCATIONS

This facility enables you to store and manage destinations in the system memory (e.g. place of work, home, favourite restaurant or areas to avoid).

From the Stored Locations menu, in addition to destinations and waypoints, you can save up to 106 memory points, add your home address and save up to 10 areas to avoid.

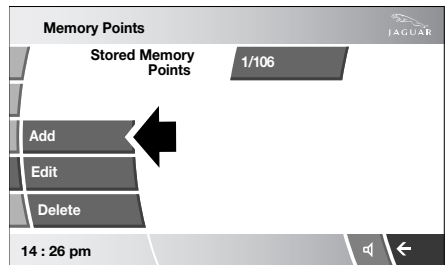
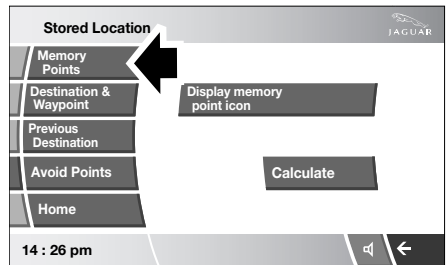

JOL4551ENG

Touching any of the **Stored Locations** submenus, shown in the top illustration above, allows you to **Add**, **Edit** or **Delete**.

Note: The screen above appears in many of the navigation submenu selections.

Navigation system

To store a memory point

A memory point can be programmed using any of the methods for entering a destination. For this example we will choose a motorway exit for the M69.

1. Select **Memory Points** from the Stored Locations menu.
2. Select **Add**.

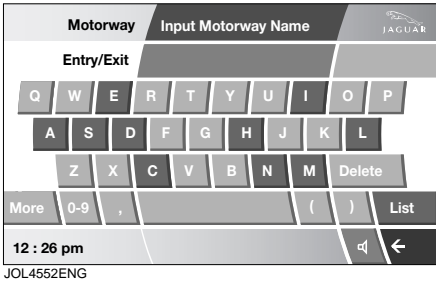

3. Touch the motorway letter **M**, then select **0-9**, to change the display to a numeric keypad.
4. Enter **69** using the keypad.

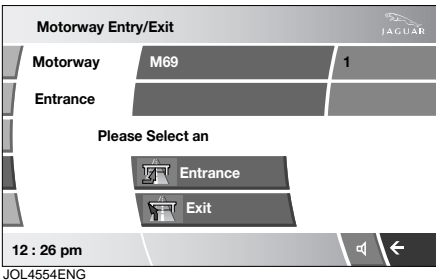

5. Choose **Exit**.

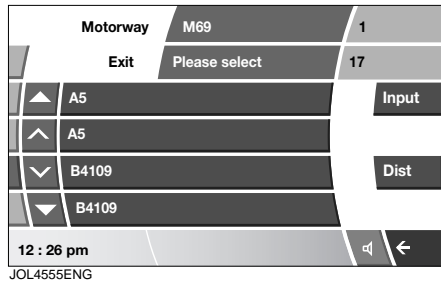

Select the desired exit from the list (e.g. the **A5**).

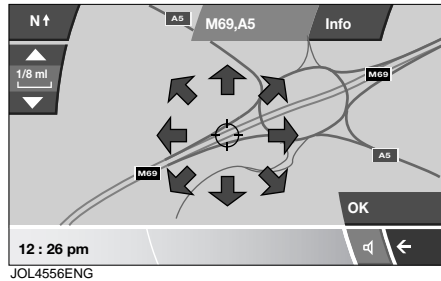

The map centres on the selected motorway exit. Touch **OK**.

The Memory Point menu displays the attributes of the memory point that can be edited.

Once the attributes are as required, select **OK**.

Information on Destination/Waypoint entry is given elsewhere in this handbook. See **DESTINATION ENTRY** (page 317).

Navigation system

AVOID POINTS

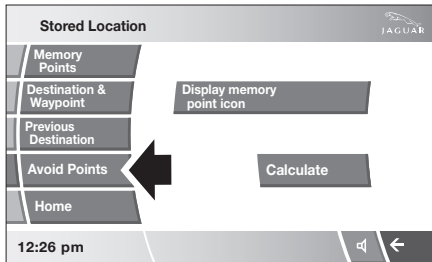

JAG1574

After a route has been selected, you can set a single or a series of locations that you wish to avoid on your route (to avoid known traffic hold-ups, for example).

- Select **Stored Locations** from the Navigation menu.
- Select **Avoid Points**.
- Select **Add**, then use one of the available options (Address, Memory, POI, Postcode, etc.) to enter the location of the area to be avoided.

HOME

From the Stored Locations menu select **HOME**.

DESTINATION ENTRY

Setting a destination

From the Navigation Menu, select **Destination Entry**.

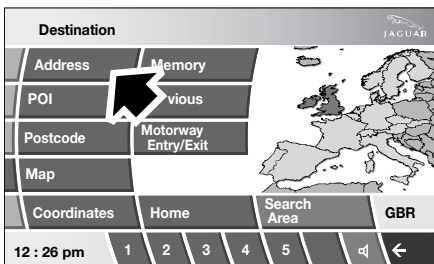

JOL4561ENG

From the Destination Entry menu, select the desired method for entering a destination. These are described on the following pages.

Choosing your route

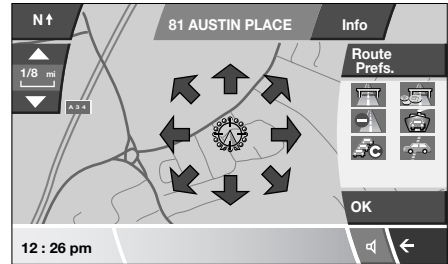

JOL4562ENG

Once the destination has been calculated options for your journey can be made by touching **Route Prefs.** or by selecting **3 Route** or **Change Route**.

Information about altering your route preferences is given earlier in this handbook. See **ROUTE PREFERENCES** (page 310).

Start guidance

When the system has calculated the route, the map is displayed.

The route will be highlighted on the map, with an icon showing your current position. The road name/number is also listed in the text area.

If no destination is set, the **Destination** key is highlighted and **Waypoint** is greyed out (not selectable).

If a destination is set and no waypoint is set both **Destination** and **Waypoint** are highlighted.

Drive away, following the voice guidance given by the system. As you approach a junction, in addition to the voice guidance, an inset on the map will display an enlarged view of the junction.

Navigation system

When your destination is reached, voice and visual confirmation is given.

Points of interest

To set a POI as destination or a waypoint. See **POINTS OF INTEREST** (page 322).

POSTCODE

Not all countries have this facility. Enter the postcode of your waypoint or destination from the keypad. Ensure that any spaces and punctuation is as used in reality otherwise the system may not find it.

Postcode formats

The following is a list of countries where the navigation system provides full postcode entry:

Austria	Italy
Belgium	Luxembourg
Denmark	Spain
France	Switzerland
Germany	United Kingdom

The following is a list of countries where the navigation system provides reduced postcode entry:

- Netherlands - The four numeric digits only, e.g. 4817
- Sweden - Only the first three digits of the postcode can be entered, e.g. 162 00 must be entered as 162.

When the postcode has been entered touch **OK**.

MAP

After selecting map, the local area map is displayed. If the destination or waypoint is not shown on the map, use the zoom button to increase the area. By using your finger on the touch-screen move the circle to the area for your destination or waypoint, zooming in if required.

This location can be stored as a destination or waypoint.

COORDINATES

The destination can also be entered as a set of coordinates. The full latitude must be entered before the longitude coordinates can be entered.

Coordinates

1	2	3	LAT			
4	5	6	N	S	↑2_	Delete
7	8	9	LONG			
	0		W	E		Delete
o	'		OK			

12 : 26 pm

JOL4566ENG

Coordinates

1	2	3	LAT			
4	5	6	N	S	↑22°	Delete
7	8	9	LONG			
	0		W	E	Input Longitude	Delete
o	'		OK			

12 : 26 pm

JOL4566ENG

When the coordinates have been entered, touch **OK**.

Navigation system

If the coordinates entered are not contained within the area covered by the DVD, a message will be shown. This can also occur if the incorrect coordinates have been entered.

POINTS OF INTEREST (POI)

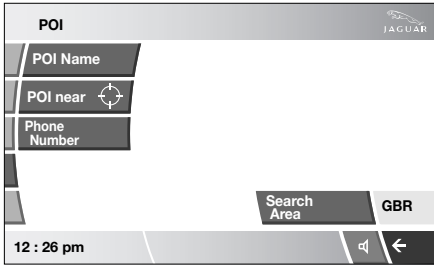

Select **POI Name**, **POI Near** or a **Search Area** from the Destination menu screen.

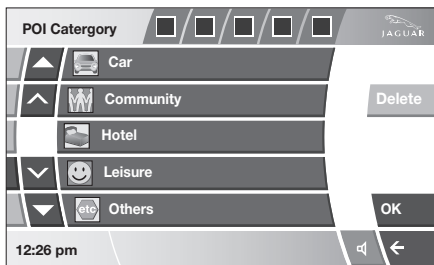

Input the POI name using the keypad or select **Category** or **List** to see the complete list of POIs.

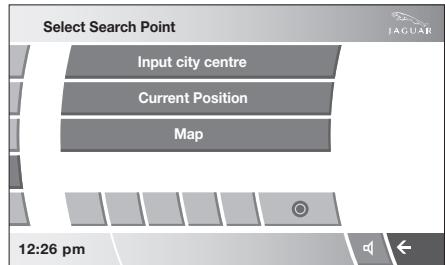

Select the POI name, or select a search area such as a city centre to find the selected POI.

PREVIOUS

After selecting **Previous** from the menu, the screen shows a list of stored previous destinations. Select your destination, by touching the bar, and the details are displayed for confirmation.

Note: *Whilst driving, list scrolling is not active. You can only choose from the items shown at the top of the list.*

Navigation system

MOTORWAY

This enables you to select a motorway exit or entrance as a destination or as part of a route itinerary.

From **Destination Entry** select **Motorway Entry/Exit**.

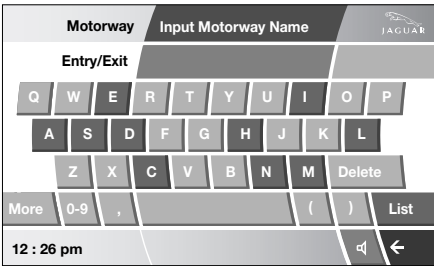

JOL4552ENG

Enter the motorway name or number. In this example the M69 is selected with a destination of Nuneaton, exiting the M69 on to the A5.

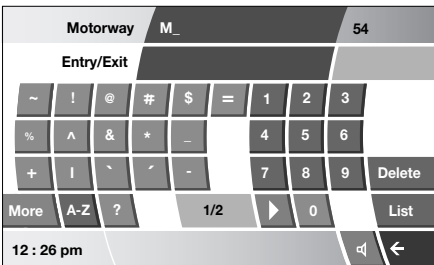

JOL4553ENG

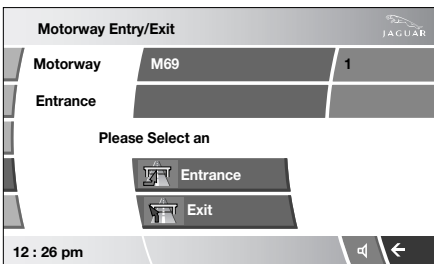

JOL4554ENG

Now select an entrance or exit.

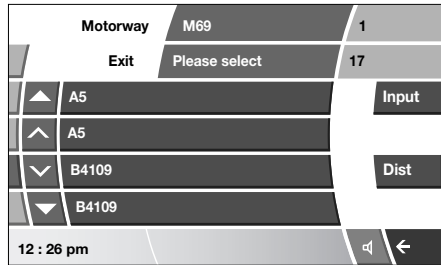

JOL4555ENG

The screen gives all of the entrance or exit junctions on the M69. Choose the A5.

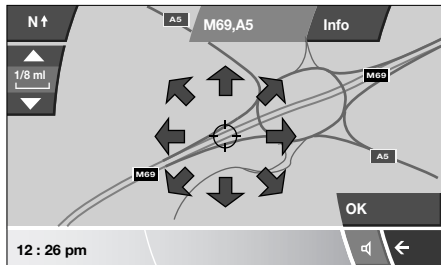

JOL4556ENG

The map showing the selected motorway and the selected exit junction is displayed.

Select **Destination**.

The destination has now been set and the route is calculated.

Navigation system

COMPASS

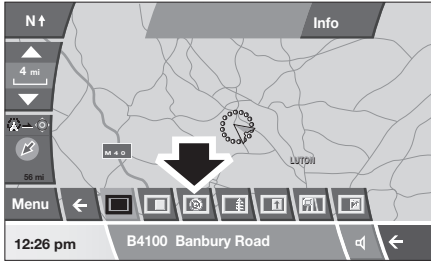

JAG1581

Select the compass icon and the compass will be displayed.

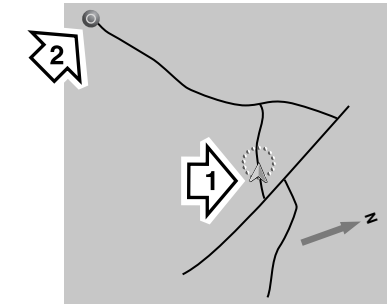
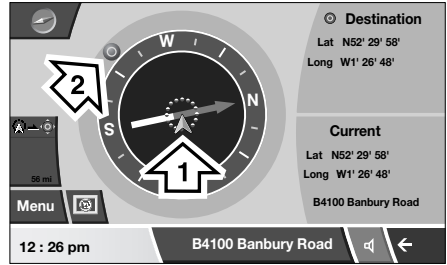
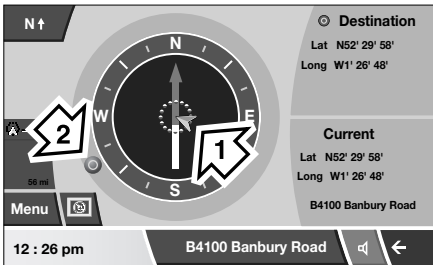

JOL4573ENG

In this illustration the car (1) position faces upwards to the top of the map and item (2) is the destination or next waypoint.

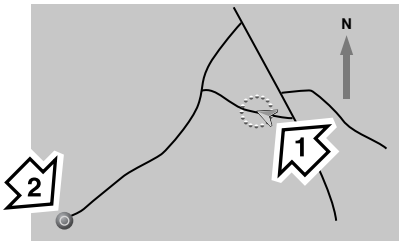

JOL4572ENG

The illustration above shows the map display always facing North. The car (1) position faces its compass direction of travel and item (2) is the destination or next waypoint.

Navigation system

POINTS OF INTEREST

The Navigation System DVD contains information about a large number of points of interest (POI). There are many categories of POI, including fuel stations, restaurants, railway stations and hospitals.

This chapter explains how to select a specific POI. A selected POI can be set as a destination. From the Destination Entry menu, select **POI**.

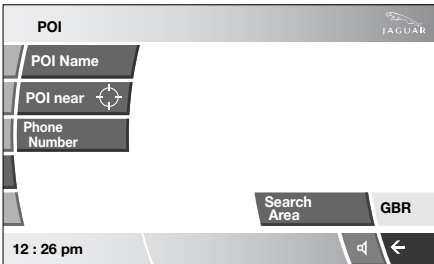

JOL4584ENG

Select **POI Name**.

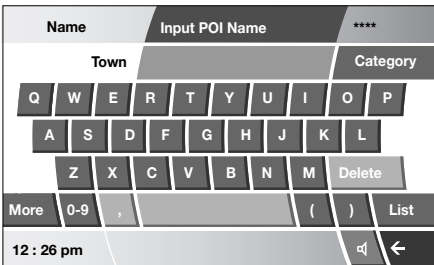

JOL4585ENG

Input the POI name, for example Petrol to display fuel stations on the map, or touch **Categ** for a list of POI categories.

If the category is not displayed, select **List** from the POI category menu and scroll through the list and select the desired category. The Input POI Name menu is displayed again.

Select **List** to view all the POIs within the chosen category and select the required POI.

A map screen is displayed so that the destination can be fine-tuned. Once correct, select **Destination** to set the POI as the destination for this journey.

The map navigation screen is displayed, with the route highlighted. Select **Start** to begin the journey.

Note: POI icons can only be displayed up to the 1 km (½ mile) zoom level.

POI ICON DISPLAY

After selecting a category, the map display shows the location of each POI in the selected category, indicated by the appropriate POI icon.

For information about a particular POI, touch the desired POI icon.

List of icons

Shopping



Shopping Centre

Travel



Park & Ride

































Railway Station



Tourist Information

Navigation system

		Airport			Hospital
		Bus Station			Park & Recreation
		Ferry Port			Town Hall
		Motorway Service Station			
			Leisure		
Hotel					
					Bowling Centre
Car					Casino
					Cinema
		Car Rental			Golf Course
		Jaguar Dealer			Ice Skating Rink
		Parking			Music Club
		Petrol Station			Ski Resort
Community					Sports Centre
					Tourist Attraction
		Community Centre			Vineyard
		Exhibition Centre			

Navigation system

Others



Historical Monument



Italian



Japanese



Other Restaurants

Others continued



Museum



Theatre



Town Centre



University/College

Restaurant



All Restaurants



Chinese



Fast Food



French

CANCELLING POI ICON DISPLAY

If the display of POI icons is no longer required, they can be turned off as follows:

- Touch the map screen to display the additional buttons.
- Touch **POI Off** to cancel the display of POI icons on the map.

JAGUAR DEALERSHIP LOCATIONS

Details of Jaguar Dealerships are held on the Navigation System DVD as a points of interest (POI) category. Certain Dealers may be located in areas that are not fully mapped on the DVD. If a route is set to one of these Dealers, guidance may only be possible to the nearest town centre; a warning message will be displayed.

If Jaguar Dealerships (or certain other categories, such as airports) are selected, they will be displayed across all search areas.

Navigation system

ENTRY BY TOWN

If a town name is entered first, the points of interest listed will be restricted to that town.

- From the Input POI Name screen, touch **Town**.
- Enter the town name required.
- Touch **List** to display the list of possible towns.
- Select the town required.

The Input POI screen is displayed again.

- Enter the POI name required.

ENTRY BY CATEGORY

If a POI category is selected first, the points of interest listed will be restricted to that category.

OTHER SELECTION METHODS

Town centres

The POI database holds town centre locations.

To select a town centre, proceed as follows:

- From the Input POI Name screen, enter the town name required in the **Name** text area (do not select the **Town** button).
- Touch **List** to display the list of matches.
- For the town centre, select the entry showing the town name only.

***Note:** In some cases, more than one town centre location may be listed.*

CATEGORIES AND SUB-CATEGORIES

The POI database is divided into a number of categories. Each main category is further divided into a number of sub-categories.

The first entry in the list of Restaurant sub-categories, is **ALL**. This selects all of the Restaurant sub-categories.

To narrow the search, touch the **Town** button. This will display the alpha keyboard, to allow the desired town name to be entered.

Search area

When searching the database, only points of interest in the current search area are included, except for the sub-categories marked **All search areas** in the POI category list.

List button

The **List** button becomes active, when the characters entered reduce the possible entries to a small enough number (the list is displayed automatically when the number of entries reduces to four or less).

You can also select **List** (when active) without entering a POI name. All the relevant points of interest will be displayed, e.g. in a selected town or category.

All button

The **All** button returns to searching all categories after selecting one category.

POI ENTRY MESSAGES

While searching for points of interest, you may encounter one of the following messages:

1. There are no POIs in this Category.
2. No POIs Found in this Town.

Navigation system

QUICK POI SELECTION

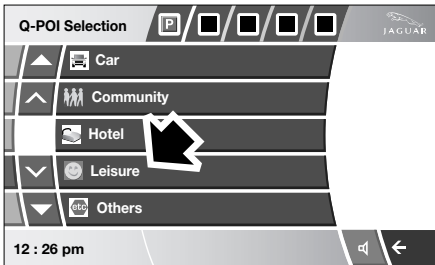
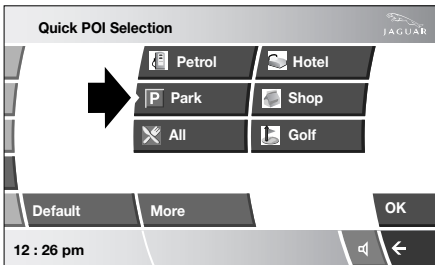
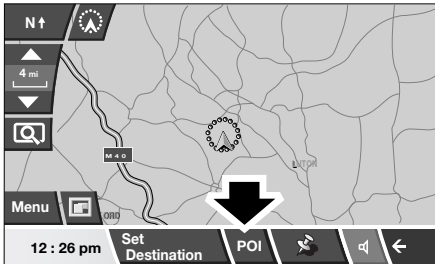

JOL4508ENG

A total of six POIs can be stored.

Changing the Quick POI Categories

The six default Quick POI categories can be changed as required.

- At the Map screen, touch anywhere on the map.
- Touch the **POI** button.
- Select the Quick POI category that you wish to replace.

The screen shows the full list of POI categories.

- Select the new category required from the list.

The screen shows the new selection of category icons.

- Repeat for another category icon if required.
- Touch **OK** to apply the new settings.

SELECTING A QUICK POI CATEGORY

- Touch the Initial Map screen, then touch the POI button. The screen shows the six categories currently selected for quick points of interest.

Note: The POI button will not be active if the zoom level is below 1 km (½ mile).

- Select a Quick POI category.

The map screen is displayed with POI icons.

Other categories

You can also select from the complete list of POI categories.

- Touch **List Categories** and select a category from the list displayed.

Local POI search

This selects the points of interest in all categories within 32 kilometres (20 miles) of the vehicle.

- Touch the **All Local POIs** button.

Navigation system

MEMORY POINTS

The procedure for using memory points is functionally the same as for using the Quick Points of Interest.

The map display shows the location of all stored memory points in view.

- For information about a particular memory point, touch the desired memory point icon.

After touching the memory point icon, the name of the selected memory point is displayed at the top of the screen.

Note: Unlike POIs, memory points are displayed at all zoom levels.

Memory point details

- Touch **Info.** to display the details of the selected memory point.

The details include Icon, Name, Position and Tel. The telephone number can be called by touching the telephone button, if a Jaguar telephone is fitted.

The memory point details can be edited.

RDS-TMC OVERVIEW

Radio Data System-Traffic Master Channel (RDS-TMC) is a feature that announces traffic hold-ups in your local area. It uses radio programmes to seek these hold-ups.

Touch the RDS-TMC button on the Navigation Setup menu to access the TMC menu.

Touch the **Change** button - the system begins a search of all radio stations being received in your locality.

The tuner will scan the FM frequency once and this may take a few minutes. **Searching** will be displayed while scanning is in progress.

When a station is found which is offering TMC information, the RDS name is shown on the list and the search for more stations will continue.

Note: In the United Kingdom the station giving TMC information is Classic FM.

Select **Change** or touch the button next to the desired station in the list, to stop the search at any time and select any stations presented on the list.

RDS-TMC display

When a TMC signal is received the icon in the top left of the screen will appear gray. If a TMC signal is not being received, the icon will be shown with a bar through it.

The system will inform the driver of any roadworks, narrow road, contraflow, accidents, slippery road, diversion, information, parking information, congestion or other hazard.

The driver is informed of a traffic event as follows:

- A TMC Event icon shown on the map at the location of the event.
- Text can be displayed showing the details of each occurrence which can be selected either by touching the screen icon or from the traffic information list.
- Voice guidance will describe the event on the route. This information will be repeated when the repeat switch is selected.
- Dynamic route guidance, which calculates an alternative route when the system receives the traffic event warning.
- Traffic event list shows all events sorted by road name/ distance on your selected route in a straight line or along your actual route.

The information regarding the hold-up is maintained and updated even if the vehicle crosses into another country.

Navigation system

RDS-TMC icons

Any traffic event (broadcast on TMC) in your area, will be displayed as a warning icon on the map and an alert may be displayed as a message giving the road number(s) and between which junctions the hold-up or event occurs. Voice guidance will also inform you of the hold-up when an event icon exists on the current route.





This data is stored in the system for up to of 30 minutes.





The colour of the TMC icon changes in order to show the type and priority of a TMC event. The background colour of the icon returns to normal when there is no longer an event or hold-up, or if any re-route instructions are calculated.

The TMC Event icons appear on the navigation map display to indicate the location and nature of a TMC event.

TMC Event icons will appear on the map, even if the event does not occur on your route.

Level 1 TMC event icons

-  Incident (Red star)
-  Moving Tailback Ahead (Red arrow)
-  Moving Tailback Both Carriageways (Red double arrow)
-  Slow Traffic Ahead (Yellow arrow)
-  Slow Traffic Both Carriageways (Yellow double arrow)

-  Information (Yellow circle)
-  Incident (Yellow star)
-  Stationary Traffic Ahead (Red arrow pointing on line)
-  Stationary Traffic Both Carriageways (Red double arrow pointing on line)

Level 2 TMC event icons

-  Other Hazard (Yellow)
-  Roadworks (Pink)
-  Narrow Road (Pink)
-  Contraflow (Pink)
-  Accidents (Pink)
-  Slippery Road (Yellow)
-  Diversion (Yellow)
-  Parking Information (Grey)

Navigation system



Information (Gray)



Congestion (Red)

USING TMC

Dynamic route guidance

Dynamic route guidance will calculate an alternative route to avoid a traffic event when the system receives an event warning.

The system calculates a new route for all sections. However, if any way points are set, the system calculates for the next way point.

If the event on route is serious (closed road) or if the new route is shorter than the current one and the current one was not recalculated within the last 5 minutes, then a message to confirm the new route will be displayed. This pop-up message will be displayed for 10 minutes and if the new route is not rejected, then the vehicle will follow the new route.

Voice guidance

While voice guidance is on, the system will give audio guidance for traffic events on route.

If the on route icon is touched, with audio guidance switched on, the audio message will be repeated. If the icon is grey, the audio guidance function has been switched off and touching the icon will not repeat any message.

After the vehicle passes the event, you will be notified of the next nearest event on route.

Audio messages are not given if you are in that event.

Traffic on route

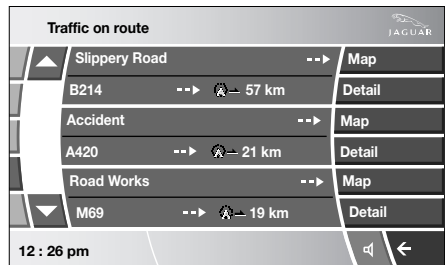
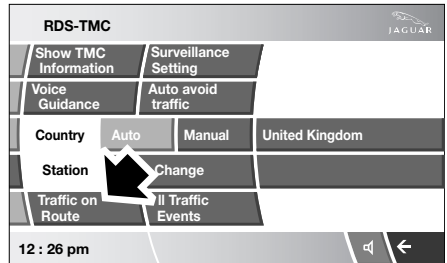

JOL4655ENG

While the vehicle is on the guidance route, the system will generate a traffic event list for that route when you touch the Traffic on Route screen button.

If a route is calculated but the vehicle is not on the highlighted route, a pop-up is displayed with an error message.

Navigation system

On route event icon

The on route event icon will show a traffic event as a line of stationary vehicles with the distance to the start point of the event. Touch the icon to repeat audio guidance (when audio guidance is switched on).

The icon will be displayed on the map with the following conditions:

- The map scale is between 50 metres and 4 km (1/32 mile and 2 miles).
- RDS-TMC setting is on and there are some events on the route.

The on route event icon will show the nearest event on the route and the distance to the event.

All traffic events

When the All Traffic Events button on the RDS-TMC setting screen is touched, all traffic events are listed by road name. If an event occurs on more than one road of your route, the system will list it with the first road name.

Each event is seen as text information from the menu.

While the list is being displayed the information is not updated.

When you select a road the system shows traffic events, if there are any, with the basic information.

Note: *The maximum text length displayed is 24 characters.*

The basic information screen shows:

- Road number.
- Brief information of the event.
- Direction and distance to the start point of the event (in a straight line).

Up to 20 events can be shown in distance order from the current vehicle position. If the event list is longer than three the remaining can be seen by scrolling the screen.

When the **Map** button is touched, the map screen will display the place of the event start point. The scale is always 500 metres (1/4 mile). If the event has finished, the map screen will still be displayed when the Map button is touched but no event icon will be shown on the map.

When the **Detail** button is touched, the system shows the detail of that event.

Navigation system

SURVEILLANCE SETTING

If you frequently travel through an area that is subject to slow or stationary traffic, it is possible to set a surveillance area which can be viewed at any time.

Up to three areas can be set for this surveillance.

RDS-TMC radio data for the selected surveillance area must be available and TMC must be enabled in order to show TMC events in this area

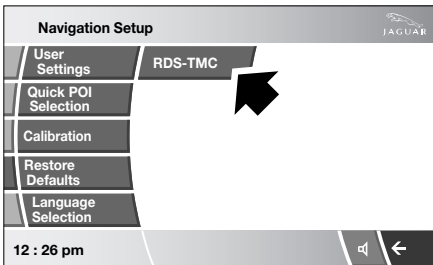

JOL4661ENG

From the Navigation Setup menu select **RDS-TMC**.

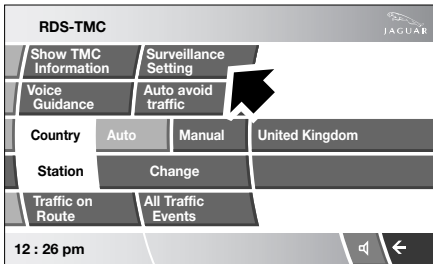

JOL4662ENG

Select **Surveillance Setting**.

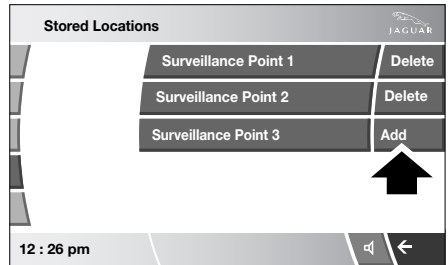

JOL4663ENG

Select **Add**.

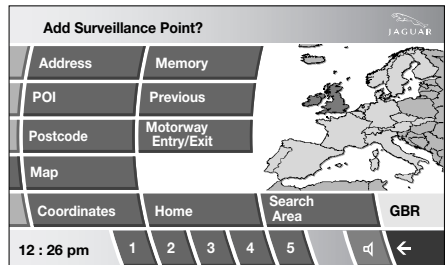

JOL4664ENG

Choose any of the methods above to select a surveillance area.

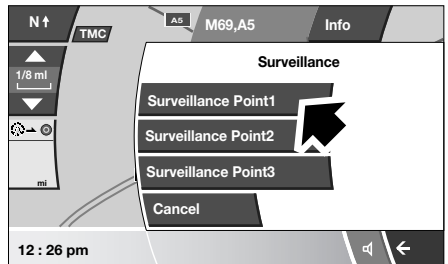

JOL4666ENG

Once the surveillance area has been selected, choose to save as any one of the three choices. The map will display the saved area.

Navigation system

ORDNANCE SURVEY DATA

Please read this agreement carefully before using the Navigation System.

This is a licence agreement to use the Ordnance Survey (OS) Code-Point data incorporated in the Navigation System. By using this Code-Point data you accept and agree to all the terms and conditions below.

Ownership

The OS Code-Point data is licensed by Ordnance Survey with permission of Her Majesty's Stationery Office.

© Crown Copyright. All rights reserved.

Licence grant

OS grants you a non-exclusive licence to use your copy of the OS Code-Point data for your personal use solely as part of the Navigation System. You may transfer the licence to a subsequent purchaser of the vehicle with which the Navigation System is supplied, provided that the purchaser agrees to abide by each of the terms of this licence.

Licence Terms

These licence terms are governed by English Law and are subject to the exclusive jurisdiction of the English courts.

Limitations of use

The OS Code-Point data is restricted for use in the specific system for which it was created. Except to the extent explicitly permitted by mandatory applicable laws, you may not extract or re-utilise any part of the contents of the OS Code-Point data, not reproduce, copy, modify, adapt, translate, disassemble, decompile, or reverse engineer any portion of the OS Code-Point data.

Limitation of liability

Ordnance Survey does not warrant or represent that any of the Code-Point data is accurate, error-free or suitable for your purposes. In no event shall OS or the supplier of the Navigation System using the OS Code-Point data be liable for any consequential, special, incidental or indirect damages for any direct or indirect loss of revenue, profits, business, data, or use, incurred by you or any third party arising out of your use of the OS Code-Point data, whether in an action in contract or tort (including negligence and breach of statutory duty) or otherwise, even if OS or the supplier of the Navigation System has been advised of the possibility of such damages. In any event, OS's liability for direct damages is limited to the price of the copy of the OS Code-Point data. Nothing in these licence terms shall operate to exclude or limit any liability which cannot be excluded or limited by law.

THE DISCLAIMER OF WARRANTY AND LIMITATION OF LIABILITY, SET FORTH IN THIS AGREEMENT, DO NOT AFFECT OR PREJUDICE YOUR STATUTORY RIGHTS WHERE YOU HAVE ACQUIRED THE DATABASE OTHERWISE THAN IN THE COURSE OF A BUSINESS.

Navigation system

NAVTEQ CORPORATION

Please read this agreement carefully before using the Navigation System.

This is a licence agreement for your copy of the Navigable Map Database, (the 'DATABASE') originally made by NAVTEQ Corporation), used in the Navigation System. By using this DATABASE you accept and agree to all the terms and conditions below.

Ownership

The DATABASE and the copyrights and intellectual property or neighbouring rights therein are owned by NAVTEQ Corporation or its licensors.

Licence grant

NAVTEQ Corporation grants you a non-exclusive licence to use your copy of the DATABASE for your personal use or for use in your business' internal operations. This license does not include the right to grant sub-licenses.

Limitations of use

The DATABASE is restricted for use in the specific system for which it was created. Except to the extent explicitly permitted by mandatory applicable laws, you may not extract or re-utilise substantial parts of the contents of the DATABASE, not reproduce, copy, modify, adapt, translate, disassemble, decompile, or reverse engineer any portion of the DATABASE.

Transfer

You may not transfer the DATABASE to third parties, except together with system for which it was created, provided that you do not retain any copy of the DATABASE, and provided that the transferee agrees to all terms and conditions of this agreement.

Disclaimer of warranty

NAVTEQ Corporation does not warrant or make any representations regarding, either express or implied, regarding the use or results of the use of the DATABASE in terms of its correctness, accuracy, reliability, or otherwise and expressly disclaims any implied warranties of quality, performance, merchantability, fitness for a particular purpose or non-infringement.

NAVTEQ Corporation does not warrant that the DATABASE is or will be error-free. No oral or written information or advice provided by NAVTEQ Corporation, your supplier or any other person shall create a warranty.

Limitation of liability

The price of the DATABASE does not include any consideration for assumption of risk of consequential, indirect or unlimited direct damages which may arise in connection with your use of the DATABASE.

Accordingly, in no event shall NAVTEQ Corporation or supplier of the navigation system using the DATABASE ('Supplier') be liable for any consequential, special, incidental or indirect damages, including without limitation, loss of revenue, data, or use, incurred by you or any third party arising out of your use of the DATABASE, whether in an action in contract or tort or based on a warranty, even if NAVTEQ Corporation or the Supplier has been advised of the possibility of such damages. In any event, NAVTEQ Corporation's liability for direct damages is limited to the price of your copy of the DATABASE.

Navigation system

THE DISCLAIMER OF WARRANTY AND LIMITATION OF LIABILITY, SET FORTH IN THIS AGREEMENT, DO NOT AFFECT OR PREJUDICE YOUR STATUTORY RIGHTS WHERE YOU HAVE ACQUIRED THE DATABASE OTHERWISE THAN IN THE COURSE OF A BUSINESS. Some states and laws do not allow the exclusion of implied warranties, so the above disclaimer may not apply to you.

WARNING



The DATABASE reflects reality as existing before you received the DATABASE and it comprises data and information from government and other sources, which may contain errors and omissions. Accordingly, the DATABASE may contain inaccurate or incomplete information due to the passage of time, changing circumstances, and due to the nature of the sources used. The DATABASE does not include or reflect information on - inter alia - neighbourhood safety; law enforcement; emergency assistance; construction work; road or lane closures; vehicle or speed restrictions; road slope or grade; bridge height, weight or other limits; road or traffic conditions; special events; traffic congestion; or travel time.

Government end users

If the DATABASE is for a region of North America and is being acquired by or on behalf of the United States government or any other entity seeking or applying rights similar to those customarily claimed by the United States government, the DATABASE is licensed with 'limited rights'.

Utilization of the DATABASE is subject to the restrictions specified in the 'Rights in Technical Data and Computer Database' clause at DFARS 252.227-7013, or the equivalent clause for non-defence agencies. Manufacturer of the DATABASE of North America is NAVTEQ Corporation, 10400 W. Higgins Road, Suite 400, Rosemont, Illinois 60018, USA.

EUROPEAN DECLARATION OF CONFORMITY

 Hereby, DENSO CORPORATION declares that this DN-NS-019 is in compliance with the essential requirements and other relevant provisions of Directive 1999/5/EC.

Appendices

TYPE APPROVALS

Garage door opener radio transceiver (EuroHomeLink 2000)

Country	Approval No.
Austria	GZ104569-ZB/98
Belgium	RTT/D/X2064
Czech Republic	CTU 2000 3 R 1194
Cyprus	MCW129/95 12/2000
Denmark	98.3142-266
Finland	FI98080106
France	97619RD
Germany	D800038K
Gibraltar	RTTE 20754/0087847
Greece	JCI 05JUL2000 RTTE
Hungary	BB-5793-1/2000
Ireland	TRA 24/5/109/5
Iceland	IS-3418-00
Italy	DGPGF/4/341032/TB 0002573
Luxembourg	L2433/10510-03J
Malta	WT/122/98
Netherlands	NL99030970
Norway	NO20000026
Poland	URT-GP-CLBT-431-66/2002/C
Reunion, Martinique etc.	97619 RD
Portugal	JCI 03JUL2000 RTTE
Slovak Republic	R 267 2001 N
Spain	0416 00
Sweden	Ue990195
Switzerland	BAKOM 98.0746.K.P
Turkey	0425/TGM-TR/JOCO-EURO
United Kingdom	RTTE 20754/0087847
South Africa	TA 598/2002
Australia	27NOV2002
New Zealand	02DEC2002

Appendices

Country	Approval No.
Jordan	TRC/LPD/2002/20
Kuwait	14JAN2002
Saudi Arabia	SAP20554184
UA Emirates	K8133510-CC
Monaco	PC/cp-CI. T55-03/04672
Andorra	16SEP2003
Chile	12DEC2001
Croatia	SRD-156/03
Estonia	5-4796/04_1_2
Latvia	5-4796/04_1_2
Lithuania	5-4796/04_1_2
Slovenia	5-4796/04_1_2
Russia	POCC DE.MJ05.H00016

Jaguar Smart Key remote control radio frequency

Vehicles without passive entry

CAUTION



The key transmitter may suffer interference from other legal users of this radio frequency band, such as radio amateurs, medical equipment, remote controls or alarm systems. To lock the vehicle, either use a key or operate the transmitter as close to the security antenna on the front screen as possible.

Appendices

Transmitter statement in accordance with 2004/104/EC

The fitment of transmitters that utilise the following frequency bands and powers is permitted within this vehicle.

Service	Frequency band	Max output	Antenna position	Specific conditions
4m VHF	70-85 HMS	30W/CW 40W/AM	Anywhere on the metallic part of the roof.	Transmitter, harness and antenna installation to the requirements of ISO/TS 21609
2m VHF	142-175 MHz	30W/CW 40W/AM	Anywhere on the metallic part of the roof.	Transmitter, harness and antenna installation to the requirements of ISO/TS 21609
TETRA	380-422 MHz	10W/CW 10W/PM	Anywhere on the metallic part of the roof.	Transmitter, harness and antenna installation to the requirements of ISO/TS 21609
UHF	450-470 MHz	10W/FW	Anywhere on the metallic part of the roof.	Transmitter, harness and antenna installation to the requirements of ISO/TS 21609
Bluetooth	2400-2483.5 MHz	10mW	Anywhere on the vehicle.	Transmitter, harness and antenna installation to the requirements of ISO/TS 21609
Road telematics	5795-5815 MHz	2W eirp	Anywhere close to a glazed area.	Transmitter, harness and antenna installation to the requirements of ISO/TS 21609
Road telematics	63-64 GHz	2W eirp	Anywhere close to a glazed area.	Transmitter, harness and antenna installation to the requirements of ISO/TS 21609

Appendices

Declarations of conformity

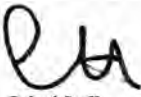
Declaration of Conformity appropriate to the Directive 1999/5/EC (R&TTE) Annex IV	
Visteon Deutschland GmbH Manufacturer,	
Notified Body consulted:	Phoenix Test-Lab, Königswinkel 10, D-32825 Blomberg
ID-Number of Notified Body:	0700
declare under our responsibility that the product:	RKE Transmitter
Type:	TXREL
<input type="checkbox"/> Telecommunications Terminal Equipment	<input checked="" type="checkbox"/> Radio Equipment
Remote Keyless Entry System Transmitter	I
..... Intended Purpose Equipment Class
complies with the appropriate essential requirements of the Article 3 of the R&TTE and the other relevant provisions, when used for its intended purpose.	
Health and Safety requirements contained in Article 3 (1) a)	
EN 60 950: 2001 Information technology equipment – Safety – Part 1: General Requirements. EN 50 371: 2002 , Generic standard to demonstrate the compliance of low power electronic and electrical apparatus with the basic restrictions related to human exposure to electromagnetic fields (10 MHz – 300 GHz) – General public.	
Protection requirements with respect to electromagnetic compatibility Article 3 (1) b)	
EN 301 489-01 V.1.4.1: 08/2002 , Electromagnetic Compatibility and radio spectrum Matters (ERM); Electromagnetic Compatibility (EMC) standard for radio equipment and services; Part 1: Common technical requirements. EN 301 489-03 V.1.4.1: 08/2002 , Electromagnetic Compatibility and radio spectrum Matters (ERM); Electromagnetic Compatibility (EMC) standard for radio equipment and services; Part 3: Specific conditions for Short Range Devices (SRD) operating on frequencies between 9 kHz and 40 GHz.	
Means of the efficient use of the radio frequency spectrum	
<input checked="" type="checkbox"/> Air interface specification of the radio path contained in Article 3(2)	
EN 300 220-3 V1.1.1: 09/2000 , Electromagnetic compatibility and Radio spectrum Matters (ERM); Short range devices (SRD); Radio equipment to be used in the 25 MHz to 1000 MHz frequency range with power levels ranging up to 500 mW; Part 3: Harmonized EN covering essential requirements under article 3.2 of the R&TTE Directive.	
Address:	
Visteon Deutschland GmbH Visteonstrasse 4 - 10 50170 Kerpen Germany URL: http://www.visteon.com/europe	 Roland Greff Vice President Visteon Deutschland GmbH

CE 0700

Appendices

SIEMENS VDO

A u t o m o t i v e

SiemensVDO Automotive AG a.P.O. Box 10 09 43 d-93009 Regensburg

Name	Dagmar Kolar
Department	SV C TS RBG EMC-Laboratory
Tel.	+49(0)941/790-6699
Fax	+49(0)941/790-136699
E-Mail	dagmar.kolar@siemens.com
Internet	www.siemensvdo.de
Our Ref.	Doc_5WK49096.doc
Date.	03/08/2005

Declaration of Conformity in accordance with Directive 1999/5/EC (R&TTE Directive)

Manufacturer: Siemens VDO Automotive AG
Body & Chassis Electronics

Address: Dep. SV C BC P2 RF TG
Siemensstrasse 12
D-93049 Regensburg
Germany

Product type designation: 5WK4 9096

Intended use: Radio frequency receiver used in vehicle locking/unlocking systems

The product mentioned above complies with the essential requirements and other relevant provisions of Directive 1999/5/EC, when used for its intended purpose:

Health and safety pursuant to §3.1.a: *Applied standard(s):*
EN 60950:2000

Electromagnetic compatibility pursuant to § 3.1.b: *Applied standard(s):*
EN 301 489-1,-3; V1.4.1 (2002-08)

Efficient use of spectrum pursuant to § 3.2: *Applied standard(s):*
EN 300 220-1: V1.3.1 (2000-09)

The following marking applies to the above mentioned product:



Siemens VDO Automotive AG

Regensburg, 2005-08-03

.....
Jean-Francois Tarablia
Executive Vice President
Body and Chassis Electronics Operations

.....
Dr. Martin Fischer
Vice President
Wireless Products and Modules

SiemensVDO Automotive AG

Body & Chassis Electronics

Postal Address:
SiemensVDO Automotive AG

Office Address:
Siemensstrasse 12
D-93055 Regensburg
Tel. +49(0)941/790-0

Helmut Matschl
Klaus Müller

P.O. Box 10 09 43
D-93009 Regensburg

SiemensVDO Automotive AG a/Chairman of the Supervisory Board: Edward G. Kulasak a/Managing Board: Franz Wessing, Chairman a/Members: Klaus Egger, Günter Hauptmann, Johann Lötler a/Registered Office: München a/Commercial Registry: München, HRB 13263

Appendices

Declaration of Conformity appropriate to the Directive 1999/5/EC (R&TTE) Annex IV	
Visteon Deutschland GmbH Manufacturer,	
Notified Body consulted:	Cetecom ICT Services GmbH, Untertürkheimer Strasse 6-10, D-66117 Saarbrücken
ID-Number of Notified Body:	0682
declare under our responsibility that the product:	Immobiliser System Transceiver
Type:	PATS XCVR Start Control Unit
<input type="checkbox"/> Telecommunications Terminal Equipment	<input checked="" type="checkbox"/> Radio Equipment
Immobiliser System Transceiver	1
Intended Purpose	Equipment Class
complies with the appropriate essential requirements of the Article 3 of the R&TTE and the other relevant provisions, when used for its intended purpose.	
Health and Safety requirements contained in Article 3 (1) a) EN 60 950: 2001 Information technology equipment – Safety – EN 50 371: 2002, Generic standard to demonstrate the compliance of low power electronic and electrical apparatus with the basic restrictions related to human exposure to electromagnetic fields (10 MHz – 300 GHz) – General public.	
Protection requirements with respect to electromagnetic compatibility Article 3 (1) b) EN 301 489-03 V.1.4.1: 08/2002, Electromagnetic Compatibility and radio spectrum Matters (ERM); Electromagnetic Compatibility (EMC) standard for radio equipment and services, Part 3: Specific conditions for Short Range Devices (SRD) operating on frequencies between 9 kHz and 40 GHz.	
Means of the efficient use of the radio frequency spectrum <input checked="" type="checkbox"/> Air interface specification of the radio path contained in Article 3(2) EN 300 330-1 V1.3.2: 12/2002 and EN 300 330-2 V1.1.1: 06/2001, Electromagnetic compatibility and Radio spectrum Matters (ERM); Short range devices (SRD); Radio equipment in the frequency range 9 kHz to 25 MHz and inductive loop systems in the frequency range 9 kHz to 30 MHz; Part 1: Technical characteristics and test methods and Part 2: Harmonized EN under article 3.2 of the R&TTE Directive.	
Address: Visteon Deutschland GmbH Visteonstrasse 4 - 10 50170 Kerpen Germany URL: http://www.visteon.com/europe	
 Roland Greff Vice President Visteon Deutschland GmbH	

CE 0682

Appendices

European Union Directives Conformance statement for the telephone system

WARNING



Changes or modifications not expressly approved by the party responsible for compliance could void the user's authority to operate the equipment.



Hereby, Jaguar Cars Limited declares that this product is in compliance with:

- The essential requirements and other relevant provisions of Directive 1999/5/EC.
- All other relevant EU Directives.

IMEI: 350034/40/394721/9

CE0168

Type: MC2-41H14

E92510

The above gives an example of a typical Product Approval Number.

You can view your product's Declaration of Conformity (DoC) to Directive 1999/5/EC (the R&TTE Directive) at:

- www.motorola.com/rtte

To find your DoC, enter the Product Approval Number from your product's label in the Search bar on the website.

The Bluetooth® word mark and logos are owned by the Bluetooth SIG, Inc. and any use of such marks by Jaguar Cars Limited is under licence. Other trademarks and trade names are those of their respective owners.

Audio system EEC Conformance

In conformance with current EC guidelines, any person may operate this radio receiver. This unit conforms to the current valid European or harmonised national regulations. The designation is your guarantee of conformance to the applicable specifications concerning electromagnetic compatibility for the unit. This means that interference affecting other electrical or electronic devices caused by your unit, as well as interfering influences on your unit from other electrical or electronic devices, can be largely prevented.

Current valid designations are:

CE symbol for issue according to European guideline 89/336/EEC under application of the following standards:

EN 55013

EN 55020

e symbol according to European motor vehicle EMC guideline 95/54/EU, also permits operation in motor vehicles (classes M, N and O) which receive their type approval after 1st January 1996.



021473

E92511

The above gives an example of a typical Product Approval Number.

Appendices



E92512

Dolby Pro Logic Surround and the double-D are registered trademark of Dolby Laboratories. Manufacturing rights for Dolby Pro Logic Surround System are licensed from Dolby Laboratories Licensing Corporation.

Appendices

Declaration of conformance for the Tyre Pressure Monitoring System (TPMS) sensors

SIEMENS VDO
A u t o m o t i v e

Siemens VDO Automotive AG - P.O. Box 10 09 43 - D-93009 Regensburg

Name	Regina Quegwer
Department	SV C BC P2 RF TG
Tel.	+49(0)941/790-3554
Fax	+49(0)941/790-133 554
E-Mail	Regina.Quegwer@siemens.com
Internet	www.siemensvdo.de
Our Ref.	Doc_S120123.doc
Date.	4/03/2004

Declaration of Conformity in accordance with Directive 1999/5/EC (R&TTE Directive)

Manufacturer: Siemens VDO Automotive AG
Body & Chassis Electronics

Address: Dep. SV C BC P2 RF TG
Siemensstrasse 12
D-93055 Regensburg
Germany

Product type designation: S120123

Intended use: Radio frequency transmitter used Tire Pressure Monitoring system

The product mentioned above complies with the essential requirements and other relevant provisions of Directive 1999/5/EC, when used for its intended purpose:

Health and safety pursuant to §3.1.a: *Applied standard(s):*
EN 60950: 2000

Electromagnetic compatibility pursuant to § 3.1.b: *Applied standard(s):*
EN 301 489 -1,-3: V1.4.1 (2002-08)

Efficient use of spectrum pursuant to § 3.2: *Applied standard(s):*
EN 300 220 -1: V1.3.1 (2000-09)

The following marking applies to the above mentioned product:



Siemens VDO Automotive AG
Regensburg, 2004-03-04

.....

Jean-Francois Tarabbia
Executive Vice President
Body and Chassis Electronics Operations

.....

Norbert Müller
Vice President
Wireless Products and Modules

Siemens VDO Automotive AG - Body & Chassis Electronics

Helmut Matschl
Klaus Müller

Postal Address:
Siemens VDO Automotive AG
P.O. Box 10 09 43
D-93009 Regensburg

Office Address:
Siemensstraße 12
D-93055 Regensburg
Tel. +49(0)941/790-0

Siemens VDO Automotive AG - Chairman of the Supervisory Board: Eberhard G. Hindle - Managing Board: Franz Wessing, Chairman - Members: Klaus Eggler, Günter Hauptmann, Jürgen Löhner - Registered Office: München - Commercial Registry: München, HRB 13397

Appendices

SIEMENS VDO
A u t o m o t i v e

Siemens VDO Automotive AG - Postfach 10 99 43 - 93009 Regensburg

Name	Schneider Tanja
Department	SV C BC P2 RF TG
Phone	+49(0)941/790-6622
Fax	+49(0)941/790-90921
E-Mail	tanja.schneider@siemens.com
Internet	www.siemensvdo.de
Your Letter	
Our Ref.	DoC_5WK45685_4
Date.	07.04.2004

Declaration of Conformity

We, the undersigned, declare that

-the transmitter S120123001 is manufactured for different customers. All transmitters use the same schematic, pcb and assembly. The following type designation is used:

5WK4 5685 for customer Land Rover and Jaguar.

-the transmitter S120123002 is manufactured for different customers. All transmitters use the same schematic, pcb and assembly. The following type designation is used:

5WK4 5684 for customer Land Rover and Jaguar.

Yours truly,

Siemens VDO Automotive AG

i.v.

Jean-Francois Tarabbia
Executive Vice President
Body & Chassis Electronics Operations

i.v.

Norbert Müller
Vice/President
Wireless Products and Modules

Siemens VDO Automotive AG Body & Chassis Electronics

Helmut Matschi
Klaus Müller

Postal Address:
Siemens VDO Automotive AG

Postfach 10 99 43
93009 Regensburg

Office Address:
Siemensstraße 12
93055 Regensburg
Tel. +49(0)941/790-02

Siemens VDO Automotive AG - Chairman of the Supervisory Board: Professor Dr. Edward G. Kussalle - Managing Board: Wolfgang Dehen, Chairman - Members: Dr. Klaus Egger, Günter Heuchmann, Reinhard Probst - Registered Office: München - Commercial Registry: München, HRB 132037
/VP02TZLA417mi_7D1TG16_DC_LRNLeitwert_Aspw/DoC_5WK45685_4.doc

E92514

Appendices

SIEMENS VDO
A u t o m o t i v e

Siemens VDO Automotive AG - Postfach 10 09 43 - 93009 Regensburg

Name Regina Quegwer
Abteilung SV C CE AIS LF
Tel. +49(0)941/790-3554
Fax +49(0)941/790-133554

E-Mail Regina.Quegwer@siemens.com

Internet www.siemensvdo.de
Ihr Schreiben
Unser Zeichen Decl_variant_8883_6.doc
Datum 22.08.2002

Declaration of Conformity

We, the undersigned, declare that the

Receiver type 5WK4 8883 and 5WK4 8886 are based on receiver type 5WK4 8812.

The assembly and layout differs in the following items:

**Data Filter
Data Slicer
VCC blocking capacitor
ESD protection**

The changed assembly and layout does not influence the RF characteristics.

Yours truly,

Siemens VDO Automotive AG

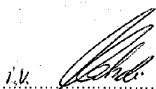
.....
Helmut Matschi
Vice President and CEO
Carbody Electronics

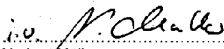
.....
Norbert Müller
Director
Access & Immobilisation Systems

Siemens VDO Automotive AG Carbody Electronics

Helmut Matschi
Dr. Raymund Müller

Briefadresse:
Siemens VDO Automotive AG
Postfach 10 09 43
93009 Regensburg

Hausadresse:
Siemensstraße 12
93055 Regensburg
Tel. +49(0)941/790-02

Siemens VDO Automotive AG - Vorsitzender des Aufsichtsrates: Professor Dr. Edward G. Kubacki - Vorstand: Wolfgang Dahn, Vorsitzender / Mitglieder: Dr. Klaus Egger, Günter Hauptmann, Jürgen Löffner - Sitz der Gesellschaft: München - Registergericht: München, HRB 153037

SIPOSTZULAEEMDD:4309696900952-440000001_variant_8883_6.doc

E92515

Appendices

SIEMENS

Name Regina Quegwer
Department AT BE AS SI 3
Tel. +49(0)941/202-35 54
Fax. +49(0)941/202-95 35 54
Email: regina.quegwer@at.siemens.de
Your Letter
Our Ref. ECDOC_RF_RX3Gen433.doc
Date 2000-12-01

EC Declaration of Conformity according to Annex II of Directive 1999/5/EC

Manufacturer: Siemens Automotive AG
Access Control & Security Systems

Address: Wernerwerkstrasse 2
D-93049 Regensburg
Germany

Product type designation: 5WK4 8812

Intended use: radio receiver for vehicle locking/unlocking systems

The product mentioned above complies with the following European Directive:

1999/5/EC: Directive of the European Parliament and of the Council on radio equipment and telecommunications terminal equipment and the mutual recognition of their conformity, dated 9th March 1999.

We, the undersigned, hereby declare that our above-mentioned product complies with all essential radio test suites according to Annex II of Directive 1999/5/EC. Proof is shown by:

- test report no. 00001036, issued by the accredited test laboratory M. Dudde
Hochfrequenz-Technik, according to EN 300 220-1
- test report no. 00001038, issued by the accredited test laboratory M. Dudde
Hochfrequenz-Technik, according to EN 301 489-1, -3

Siemens Automotive AG

Regensburg, 01.12.2000

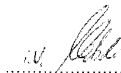

.....
Helmut Matschi
Vice President and General Manager
Access Control & Security Systems

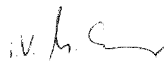

.....
Ulrich Schrey
Director Development
Access Control & Security Systems

Siemens Automotive AG

Postal Address: Office Address:
Siemens Automotive AG Wernerwerkstraße 2
AT BE AS SI 3 93049 Regensburg
P.O. Box 10 09 55 Phone
93009 Regensburg +49(0)941/202-0
Federal Republic of Germany

Appendices

SIEMENS VDO

A u t o m o t i v e

Siemens VDO Automotive AG - Postfach 10 09 43 - 93009 Regensburg

Name Thomas Heselberger
Department SV C BC P2 RF
Phone +49(0)941/790-3554
Fax +49(0)941/790-90921

E-Mail thomas.heselberger@siemens.com

Internet www.siemensvdo.de
Your Letter
Our Ref. DoC_5WK45791.doc
Date. 23.06.2005

Declaration of Conformity

We, the undersigned, declare that

The Control Unit (ECU) 5WK45692 uses the same schematic, layout and pcb as Control Unit 5WK45686.

They only differ in:

At Control Unit 5WK45692 there was made a software change to adapt several car lines.

These modifications do not influence the RF characteristics of the Body Controller.

Yours truly,

Siemens VDO Automotive AG

Regensburg, 23.06.2005

.....
Jean-Francois Tarabbia
Executive Vice President
Body and Chassis Electronics Operations

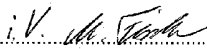
.....
Dr. Martin Fischer
Vice President
Wireless Products and Modules

Siemens VDO Automotive AG Body & Chassis Electronics

Helmut Matschi
Klaus Müller

Postal Address:
Siemens VDO Automotive AG

Postfach 10 09 43
93009 Regensburg

Office Address:
Siemensstraße 12
93056 Regensburg
Tel. +49(0)941/790-02

Siemens VDO Automotive AG - Chairman of the Supervisory Board: Professor Dr. Edward G. Krubasik - Managing Board: Wolfgang Dethen, Chairman - Members: Dr. Klaus Egger, Günter Hauptmann, Reinhard Pflanz - Registered Office: München - Commercial Registry: München, HRB 152637

INPOSTZULAToms_TGTGTB_DC_LRRLandrover_JaguarVarianten_ECU Juni 2005/DoC_5WK45692.doc

E92672

Index

A

- ABS driving hints 140
- ACC 150
- Accessories 13
- Adaptive cruise control 150
 - ACC malfunction 155
 - automatic low speed switch off 153
 - automatic switch off 153
 - changing the follow mode set gap 153
 - changing the speed 151
 - detection beam issues 154
 - entering the follow mode set gap 152
 - hints on driving with ACC 154
 - overriding the speed and follow mode 153
 - resuming the speed and follow mode 153
 - setting the speed 151
- Adaptive cruise control (ACC) 150
- Adaptive dynamics 164
- Adaptive front lighting system (AFS) 69
 - cornering or static bending lamps 70
- Adjusting the steering wheel 62
 - entry and exit mode 62
- Air conditioning 106
- Air vents 107
- Airbag labels 50
- Airbag service information 51
- Airbag warning lamp 49
- Airbags
 - deployment 47
 - driver airbag 47
 - front protection 48
 - passenger airbag 48
 - side 49
- Alarm
 - disarming 31
 - indicator light 31
 - passive arming 31
 - sensor faults 32
- Alternative frequencies 257
- Arming the alarm 18, 30
 - battery-backed sounder 32
 - intrusion sensing 32
- Ashtray 124
 - passenger door ashtrays 124
- ASL 159
- Attempting to start the vehicle 230
 - resetting the switch 230
- Audible warnings and indicators 96
- Audio
 - iPod interface 127, 277
 - portable audio interface 127, 277
 - USB interface 127, 277
- Audio control 64, 246
 - automatic volume control (AVC) 248
 - balance and fade 247
 - bass and treble 247
 - Jaguar premium surround sound 249
 - radio text sent by station 248
 - seek tuning 246
 - settings - options 247
 - settings - sound 247
- Audio controls 260
 - steering wheel controls 260
- Audio unit overview 242
 - radio system display panel (in AM-FM mode) 243
 - touch-screen audio flow chart 245
- Automatic speed limiter 159
 - ASL unavailable 160
 - exceeding the set speed 160
 - resuming ASL 159
 - setting a speed limit 159
 - suspending ASL 159
- Automatic speed limiter (ASL) 158
- Automatic transmission 133
 - automatic mode 135
 - JaguarDrive selector 133
 - limp-home mode 138
 - manual mode 137
 - message centre display 139
 - sport mode 136
 - starting 135

Index

Autostore control	251
Auxiliary connections	277
Auxiliary power sockets	125
B	
Battery	
access	193
Battery Monitoring System (BMS)	193
changing the vehicle battery	196
effects of battery disconnection	197
Battery care	192
battery disposal	196
Battery charging	196
Battery renewal (remote)	21
Battery warning symbols	192
Bonnet	
closing	181
opening	181
Bonnet lock	181
Booster cables	194
Booster cushions	57
Brake fluid check	187
Brakes	140
brake pad wear warning	140
brake pads	140
Electronic Brakeforce Distribution (EBD)	141
Bulb changing	73
side repeater lamp	77
Bulb replacement	
cornering or static bending lamp	77
front direction indicator	75
headlamp unit	73
high and low beam projector unit	76
high level brake lamp	78
number plate lamp	78
rear fog lamps	78
reverse lamps	78
side lamp	76
Bulb specification chart	78

C

Cancel guidance	312
Car wash	173
Centre console	127
Changing a bulb	73
Changing a fuse	220
checking a fuse	220
Changing a road wheel	205
locking wheel nuts	206
spare wheel location	207
stowing the equipment	209
temporary use spare wheel	206
tightening the wheel nuts	209
Changing the remote control battery	21
Channel automatic tuning	262
Channel options	262
DAB search	264
finding a channel	263
finding a subchannel	263
finding an ensemble	264
Charging the vehicle battery	196
Child seat positioning	54, 55
automatic locking reel (ALR)	54
tether anchorages and brackets	55
Child seats	52
choosing a suitable child seat	53
safety information	52
Cigar lighter	124
Cleaning alloy wheels	175
Cleaning products	173
Cleaning the exterior	173
automatic wash	174
bird droppings	175
cleaning the rear screen	175
convertible top fabric	174
glass surfaces	175
polishing	175
preparation for winter	174
removing grease and tar	175
underbonnet cleaning	174
washing the vehicle	173

Index

- Cleaning the interior 176
 - carpet and mats 177
 - cloth and fabric 177
 - floor mat retention 177
 - instrument pack and audio equipment 177
 - leather 176
 - removing stains 177
 - seat belts 177
- Climate control 106, 107
 - air conditioning 110
 - air recirculation 109
 - AUTO mode 109
 - blower speed 110
 - control panel 108
 - display icons 111
 - external temperature 111
 - heated screens 110
 - heated seats and steering wheel 110
 - panel illumination 108
 - switching off 108
 - switching on 108
 - temperature selection 109
 - touch-screen operation 111
 - use of air conditioning 106
 - windscreen defrost and demist 110
- Climate seats 37
 - backrest ventilation only 38
 - cooled ventilation 38
 - heated ventilation 37
- Clock 124
 - screen saver 124
- Compact disc display options 274
 - settings 274
- Compact disc pause 273
- Compact disc playback 273
- Compact disc selection 272
 - CD touch-screen display and operation 272
- Compass view 321
- Convenience headlamps 72
- Convenience mode 29
- Convertible top
 - deploying the luggage separator 117
 - installing the luggage separator 118
 - luggage separator 116
 - manual closure 119
 - manual re-set 114
 - message centre information displays 121
 - preparation for winter 116
 - removing the luggage separator 117
- Convertible top - closing 118
- Convertible top - opening 113
- Coolant check 186
 - topping up the coolant 186
- Cruise control 64, 148
 - automatic switch off 149
 - changing the speed 148
 - message centre information displays 149
 - resuming the speed 149
 - setting vehicle speed 148
- Cup holders 125
- D**
 - Destination entry 317
 - choosing your route 317
 - coordinates 318
 - map 318
 - motorway 320
 - points of interest 318
 - Points Of Interest (POI) 319
 - postcode 318
 - previous 319
 - setting a destination 317
 - start guidance 317
 - Differential (rear) 164
 - Digital audio broadcasting
 - general information 258
 - Dimensions 239
 - wheel alignment data (China only) 240
 - Dipstick - electronic 184
 - Direction indicators 71
 - Display options 261
 - DAB radio text 261
 - touch-screen information panel 261
 - Door lock release levers 23

Index

Drive control		
general information	161	
Drive-away locking	23	
Driver airbag	47	
Driving after a collision	230	
before starting or driving	230	
Driving dynamics		
adaptive dynamics	164	
Dynamic mode	162	
E		
Economical driving	147	
driving tips	147	
maintenance and fuel economy	147	
E-diff	164	
Ejecting compact discs	272	
Electric parking brake (EPB)	142	
Electric seats	34	
seatback tilt	35	
Electric windows	83	
anti-trap protection override	84	
automatic window drop for door		
opening	83	
one-touch operation	83	
raise and lower	83	
rear quarter window operation	85	
reset window anti-trap protection	84	
thermal overload	84	
window anti-trap protection	84	
window tinting	85	
Electronic Brakeforce Distribution (EBD)	141	
Emergency park release (EPR)	233	
Engine compartment overview	182	
Engine coolant check	186	
Engine number	237	
Engine oil check	183	
engine oil consumption	183	
oil specification	185	
Engine specifications	238	
Enhanced other network (RDS-EON)	256	
EPB	142	
Errors in vehicle position	300	
Event data recording	12	
Exterior mirrors	86	
mirror dip when reversing	86	
mirror heating	86	
power foldback - automatic operation	87	
power foldback - door switch		
operation	87	
F		
Facia and controls	10	
Fastening the seat belts	41	
Fire extinguisher	229	
maintenance	229	
First aid kit	229	
Forward alert function	156	
message centre information messages	157	
Fuel		
fuel consumption	171	
octane rating	167	
refuelling	169	
running out of fuel	168	
system fault display	169	
tank capacity	170	
Fuel consumption	171	
Fuel filler flap	168	
Fuel quality	166	
alternative fuels	167	
unleaded fuel	167	
Fuse box locations	221	
engine compartment fuse box	221	
fuse and relay positions	224	
passenger compartment fuse box	223	
rear seat compartment fuse box	222	
Fuse specification chart	225	
G		
Garage door transceiver	128	
before programming	128	
entry gate programming	130	
information and assistance	130	
programming	129	
reprogramming a single door opener		
button	130	
rolling code device equipment	129	
to erase all programming	128	

Index

- Global close 18
- Global open 17
- Global opening and closing 29
- H**
- Hazard warning flashers 68, 229
- Head restraints 36
- Headlamps
 - adaptive front lighting system (AFS) . . . 69
 - adjustment 68
 - autolamps 66
 - convenience feature 72
 - driving abroad 68
 - levelling 68
 - operation 65
 - removal 74
- Heated seats 37
- Heated steering wheel 63
- Hints on driving with ABS 140
 - Emergency Brake Assist (EBA) 141
- Horn 63
- I**
- Information displays 97
 - service interval indicator 100
- Information messages 98
- Inspecting safety system components . . . 231
- Instrument lighting dimmer 123
- Instrument panel overview 91
 - fuel gauge 91
 - message centre 91
 - message centre illumination 91
 - speedometer 91
 - tachometer 91
- Interior lamps 71
 - battery saver 72
 - glove compartment 72
 - illuminated entry and exit 72
 - luggage compartment 72
 - reading lighting 71
- Interior mirror 88
 - auto dimming 88
 - calibrating the compass 89
 - compass 88
 - inaccurate compass direction 89
 - setting the compass 88
- iPod audio interface 127, 277
- iPod connection 278
- ISOFIX anchor points 57
 - installing an ISOFIX child seat 59
 - ISOFIX child seat positioning 58
 - removing the ISOFIX seat 60
- J**
- Jump starting 194
- K**
- Keyboard layout 304
- Keyless entry 28
- Keyless locking 28
- Keyless starting 132
- Keys 24
- Keys and remote controls
 - principle of operation 15
- L**
- Lamps
 - bulb replacement 73
 - bulb specifications 78
 - daylight running lamps 67
 - direction indicators 71
 - door guard and puddle lamps 67
 - hazard warning flashers 68
 - headlamps - driving abroad 68
 - interior lighting 71
 - rear fog lamps 67
- Language selection 304

Index

Lighting	
adaptive front lighting system (AFS) . . .	69
autolamps	66
bulb replacement	73
bulb specifications	78
condensation	67
controls	65
daylight running lamps	67
direction indicators	71
door guard and puddle lamps	67
exit delay	66
hazard warning flashers	68
headlamps	65
headlamps - driving abroad	68
interior lighting	71
reading lamps	71
rear fog lamps	67
side lamps	65
Lighting control	
windscreen wiper detection	66
Load carrying	172
Loading compact discs	270
Loading the map DVD	299
Lock release levers	23
Locking	
automatic relocking	18
drive-away locking	23
global open	18
luggage compartment	23
mislock	24
multi-point entry	17
single-point entry	17
Locking and unlocking	23
steering column lock	63
Locking the vehicle	18
Luggage compartment	23
Luggage covers	172
M	
Main menu	303
Maintenance	178
technical specifications	191
Map display icons	306
Measurement units	304
Memory function	122
memorised positions	122
operating tips	122
passenger seat memory	122
recalling a memorised position	122
setting a driving position	122
Mirrors	86
heating	86
Mislock	24
Moving the vehicle	230
recovery	230
MP3 file playback	275
MP3 folder and track format	276
playing MP3 discs	275
Multi-point entry	17
N	
Navigation	
digitised area	300
getting started	301
map display icons	306
map screen	305
memory	315
menu structure	302
route preference	310
search area	308
setting a destination	308
start guidance	311
turn guidance off	312
turn voice guidance on or off	312
Navigation overview	
loading the DVD	299
Navigation setup	
calibration	313
language selection	315
quick POI selection	313, 326
restore system defaults	314
user settings	303
O	
Occupant sensing	45
airbag deactivation indicator	47
airbag location	45
occupancy classification sensor	46

Index

-
- Octane rating 167
 - Oil check 183
 - Oil level check 184
 - On/off control 246
 - Opening the bonnet 181
 - P**
 - Parking aid 143
 - cleaning the sensors 145
 - front and rear parking aid 144
 - rear fitted accessories 145
 - system fault 145
 - touch-screen 143
 - Passenger airbag 48
 - Pedestrian protection 61
 - Pedestrian protection system
 - after deployment 61
 - Personalised settings 103
 - audio system 104
 - automatic climate control 104
 - home screen display 103
 - languages and distance units 104
 - navigation system 104
 - phone 104
 - pop-up messages 103
 - timeout to home screen 105
 - touch-screen systems 104
 - vehicle system 104
 - Points of interest 322
 - cancelling the icon display 324
 - categories and sub-categories 325
 - entry by category 325
 - entry by town 325
 - entry messages 325
 - icon display 322
 - Jaguar Dealerships 324
 - list of icons 322
 - memory points 327
 - other selection methods 325
 - selecting a quick POI category 326
 - Pollution sensor 112
 - Portable audio 277
 - connecting a USB device 278
 - connecting an iPod 278
 - connecting more than one device 278
 - displaying track information 280
 - mass storage devices 278
 - portable device settings 283
 - searching a portable device 281
 - Portable audio devices 279
 - Power steering fluid
 - topping up the fluid 189
 - Power steering fluid check 189
 - Preset buttons 265
 - recalling a preset channel 265
 - storing channels as presets 265
 - Principle of operation
 - deployment 61
 - wet conditions 140
 - Programming the remote control 20
 - selecting alarm sensor override 20
 - selecting automatic relock and arm 21
 - selecting central or two stage locking 20
 - selecting drive-away locking 20
 - selecting global opening or closing 20
 - selecting passive arming 21
 - valet mode 26
 - R**
 - Radio data system (RDS) 254
 - RDS trouble-shooting guide 255
 - Radio frequencies 15
 - Radio reception 241
 - Rain sensor 80
 - RDS-TMC 327
 - all traffic events 330
 - display 327
 - dynamic navigation 329
 - icons 328
 - on route events 330
 - surveillance setting 331
 - traffic on route 329
 - using TMC 329
 - voice guidance 329
 - Rear fog lamps 67

Index

- Refuelling 169
- Regional mode (REG) 256
- Remote control 16
- care of the Jaguar Smart Key 17
 - irregular operation 17
 - unlocking the vehicle 17
- Remote control battery 21
- Remote control programming 20
- Repairing minor paint damage 175
- Rollover bars 50
- Running-in 146
- brakes 146
 - engine 146
 - engine oil consumption 146
 - final drive unit 146
- S**
- Safety 12
- Safety precautions 166
- Satellite signal reception 300
- Satellite signals 299
- Seat belt reminder 41
- seat belt warning indicator 41
- Seat belts 39
- automatic locking retractor 42
 - releasing the seat belts 41
- Seats
- lumbar support 35
- Service interval indicator 100
- Setting avoid points 317
- Settings 266
- announcements 266
 - DAB country 268
 - DAB format 269
 - DAB text 268
 - FM traffic 267
 - link DAB 267
- Shuffle/random 274
- Side airbags 49
- Single-point entry 17
- Sitting in the correct position 33
- Smog sensor 112
- Snow chains 218
- Stability control 162
- Dynamic Stability Control (DSC) 162
 - JaguarDrive Control scenarios 165
 - stability control indicator 164
 - switching between DSC and
Trac DSC 163
 - switching between DSC OFF and ON .. 164
 - tracDSC 163
- Starting the engine 131
- Station preset buttons 252
- preset memorised radio
stations (1 - 9) 252
- Storage compartments 126
- glove box 126
- Stored locations
- home 317
 - memory 315
 - setting avoid points 317
 - store a memory point 316
- Sun visors 123
- Supplementary restraints system
- advanced restraint technology system .. 43
 - principle of operation 43
- Switching off the engine 132
- T**
- Technical specifications
- capacities 191
 - lubricants and fluids 191
 - recommended tyre fitment 219
- Telephone 286
- changing the docked phone 288
 - deleting a paired phone 288
 - general information 284
- Tilt sensor 32
- Touch-screen 101
- system facilities 101
 - touch-screen care 102
 - touch-screen display icons 102
 - touch-screen use 101
- Towing
- attaching the front towing eye 235
 - on four wheels 236
- Towing points 235

Index

Track selection	273	Tyre repair kit	210
Traffic information control	252	checking the tyre pressure after a	
preset TA volume	253	repair	213
Transmission number	237	Jaguar tyre repair kit safety	
Transmitter statement	337	information	211
Transporting the vehicle	232	Tyres	
Trip computer	99	age degradation	203
average fuel consumption (A, B		directional tyres	204
and auto)	100	punctures	203
average speed (A, B and auto)	100	replacement tyres	204
changing the display	99	tyre pressures	200
display language	100	tyre wear	202
ML-km (also miles-litre)	100	wear indicators	202
odometer	99	U	
range	100	Unlocking	
reset	100	global open	17
trip computer message centre display	99	lock release levers	23
trip distance (A, B and auto)	99	luggage compartment	23
Type approvals	335	multi-point entry	17
audio system	341	single-point entry	17
Jaguar Smart Key remote control		Unlocking the vehicle	17
radio frequency	336	USB audio connection	278
Telephone system	341	USB audio interface	127, 277
tyre pressure monitoring system		Using ACC	150
(TPMS) sensors	343	Using booster cables	194
Tyre care	199	boosting from another vehicle	194
ambient temperature pressure		disconnecting the cables	195
compensation	201	Using cruise control	148
damage	203	Using seat belts during pregnancy	42
tyre pressure compensation chart -		Using snow chains	218
high ambient temperatures	202	Using the ASL	159
tyre pressures during long term		Using the key	24
vehicle storage	202	emergency key blade use	24
tyre repair	203	Using the parking aid	143
wear	202		
Tyre glossary	218		
terms used	218		
Tyre pressure monitoring system	214		
replacement sensor	216		
temporary use spare wheel	216		
TPM system information messages	217		
TPM system operation	215		
tyre changing	216		

Index

Using the remote control	16	Vents	107
activating the convenience headlamps	16	VIN	237
activating the panic alarm	17	W	
Jaguar Smart Key system transmitters	27	Warning indicators	
locking, double locking and arming		indicator check	92
the alarm	16	Warning lamps	
message centre information displays	19	indicator check	92
releasing the emergency key blade	22	Warning lamps and indicators	92
releasing the luggage compartment		adaptive cruise control (ACC)	95
lock	16	adaptive front lighting	94
unlocking and disarming the vehicle	16	airbag	95
Using the telephone	286	anti-lock braking system (ABS)	94
answer options	290	automatic speed limiter	95
changing a phone number	293	beltminder	94
continuity of calls	293	brake	93
deleting names from the Directory	295	direction indicators	95
directory contact types	294	dynamic stability control (DSC)	95
ending a call	293	engine malfunction	94
erase entire phonebook	292	forward alert	95
hands-free controls	296	hazard warning indicators	95
keyboard magnification	297	high beam	95
last 10 option	296	rear fog lamp	95
making a call	293	seat belt	93
making-ending a call	297	side lamps	95
names	294	tyre pressure monitoring system	95
other features	297	Warning triangle	229
pairing other phones	288	Washer fluid check	190
phone options	290	topping up the fluid	190
phonebook	291	Washers	
phonebook capacity	292	headlamp	81
receiving a call	293	windscreen	80
register	289	Washing	173
retrieving voice mail	289	Waveband button	251
telephone pairing and docking	286	AM/FM band switching	251
voice mail	289	Weights	238
Using winter tyres	205	Wheel changing	
V		changing a wheel	208
Valet mode		jacking the vehicle	208
deselecting	26	safety advice	207
selecting	26	Wheels and tyres	198
Vehicle build date plate	237	technical specifications	219
Vehicle certification label	237	Whiplash protection	49
Vehicle identification number (VIN)	237		

Index

Windscreen washers	80
program wash and wipe	80
Windscreen wipers	79
blade check	82
blade replacement	82
flick wipe	79
intermittent variable delay	79
operation	79
rain sensor	80
speed dependent mode	80
Winter mode	161
Winter tyres	205
approved winter tyre sizes	205
winter tyre pressures	205
Wiper blades	
changing	82
checking	82
Wipers	79

